

New Generation

Ceiling Cassette
4way

New

FDT



- Automatic energy saving control
- Keep maximum comfort with minimal draft
- Quiet operation

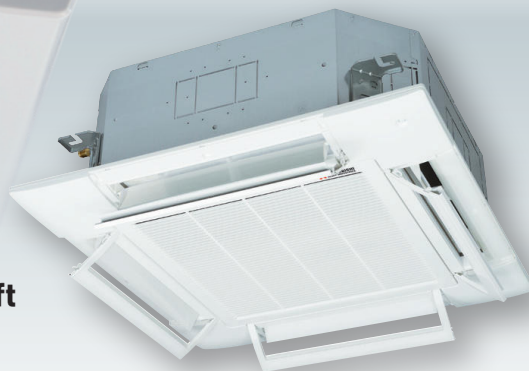

High energy efficiency with new technology

New FDT can achieve higher seasonal efficiency by utilising Mitsubishi Heavy Industries latest technology.

● SEER and SCOP is defined in European regulations. Please refer to P96.

SEER in cooling ■ Previous(VG(R410A)) ■ New(VH(R32))

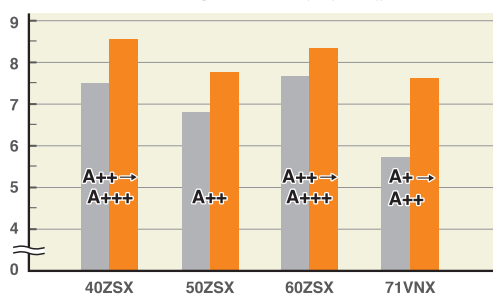

SCOP in heating ■ Previous(VG(R410A)) ■ New(VH(R32))

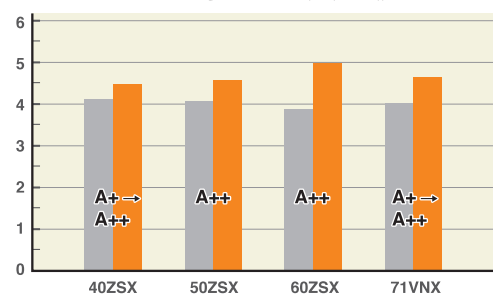

Quieter noise & Improved aerodynamic performance of the unit

New technology has realised quiet noise with keeping capacity and comfort. A low noise is achieved by reducing the pressure fluctuation in an indoor unit.

A fan guard attains both safety and quietness by flow.

New design turbo fan



Fan guard (standard equipment)



Flexible flap control for draft prevention Brand new function in the market



Draft Prevention Panel (Option)

Each of the 4 flaps can be controlled individually at each operation mode. They change air flow direction and prevent draft feeling. This new function also achieve more flexible control for air flow direction.



Motion Sensor (Option)

New motion sensor (option) detects human activity. Energy saving control is achieved by shifting set temperature according to detected amount of activity.

FDT

Indoor Unit Ceiling Cassette -4way-

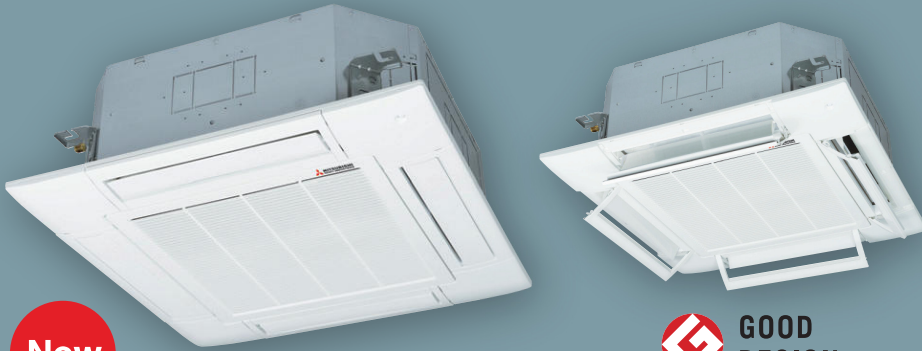

New

FDT 40/50/60/71/100/125/140

GOOD DESIGN

Draft Prevention Panel (Option)



Remote control (option)

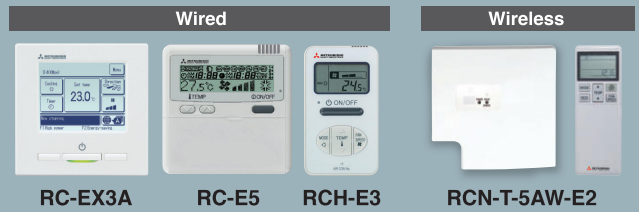

*Not all functions available with all remote control options.

Draft Prevention Panel (Option)

Draft Prevention Panel prevents cold/hot draft being blown directly on the user. It is possible to set Draft Prevention Panel for each air outlet.

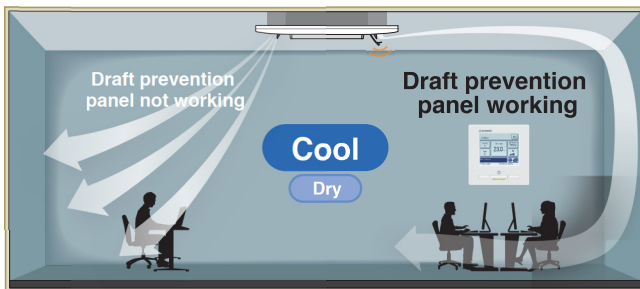

User can position panels by using the remote controller only (RC-EX3A, RCN-T-5AW-E2) when Draft Prevention Panel is available.

Motion Sensor (Option)

Motion sensor is equipped in the corner of the panel and detects the presence/absence and activity of humans in a room to improve the comfort and energy saving performance of the unit.

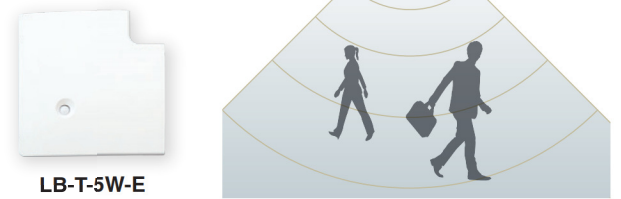

Individual Flap Control System

According to room conditions, four directions of air flow can be controlled individually by utilizing the flap control system. Individual flap control is available even after installation.

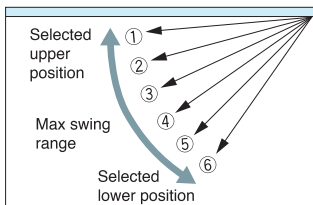

Flap can swing within an upper and lower flap range position within can be selected with a wired remote control.

※The wireless remote control is not applicable to the Individual flap control system.

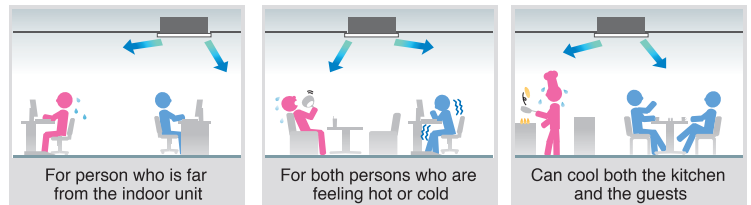
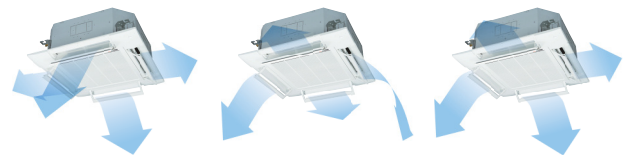

Quieter Noise

New technology has realised quiet noise (in cooling) with keeping capacity and comfort.

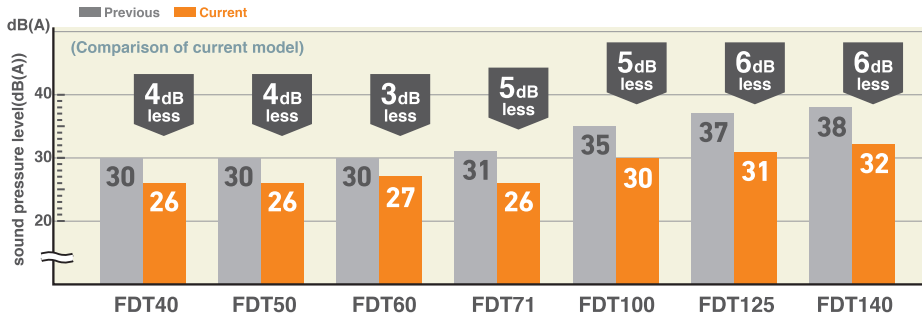

Panel Select Pattern (Option)

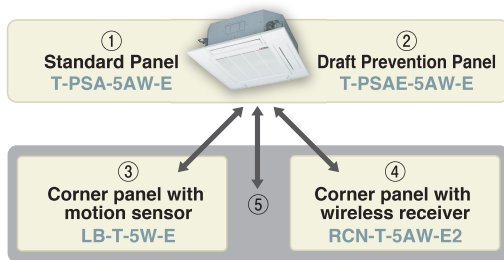

8 patterns of panel are available.

- ① Standard Panel only
- ①+③ Standard Panel with corner panel with motion sensor
- ①+④ Standard Panel with corner panel with wireless receiver
- ①+⑤ Standard Panel with corner panel with motion sensor & corner panel with wireless receiver
- ② Draft Prevention Panel only
- ②+③ Draft Prevention Panel with corner panel with motion sensor
- ②+④ Draft Prevention Panel with corner panel with wireless receiver
- ②+⑤ Draft Prevention Panel with corner panel with motion sensor & corner panel with wireless receiver

Installation position of Wireless kit and Motion sensor kit

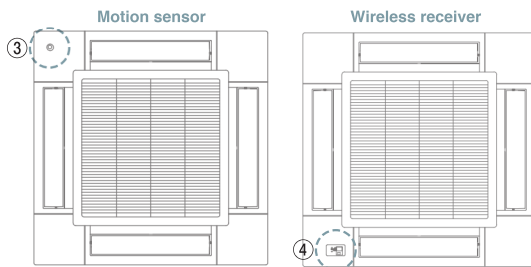

*Wireless receiver and Motion sensor can be installed to the position as shown

Suitable for High ceilings

The Powerful blowout of ultra high tap carry comfortable air flow to foot even in high ceiling. It is ideal for high ceiling offices and stores, etc., with a wide, uniform air flow throughout the room.

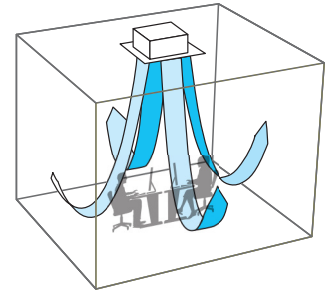

850mm Drain Pump

Drain can be discharged upwards by 850mm from the ceiling surface. It allows a piping layout with a high degree of freedom. Depending on the installation location and 185mm flexible hose as a standard equipment supports easy workability.

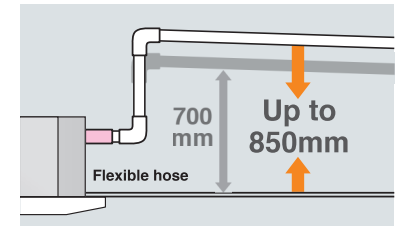

OUTDOOR UNIT

		Hyper Inverter		
SRC · FDC		40~60ZSX-W1	71VNX-W	—
		40~60ZSX-S	71VNX	100~140VN(S)X
model			New	
Chargeless		15m	30m	
Height x Width x Depth (mm)		640 x 800(+71) x 290	750 x 880(+88) x 340	1,300 x 970 x 370

		Micro Inverter			Standard Inverter		
FDC		100~140VN(S)A-W	—	—	71VNP-W	90~100VNP-W	—
		100~140VN(S)A	200VSA	250VSA	71VNP	90VNP1	100VNP
model		New			New	New	
Chargeless		30m			15m		
Height x Width x Depth (mm)		845 x 970 x 370	1,300 x 970 x 370	1,505 x 970 x 370	640 x 800(+71) x 290	750 x 880(+88) x 340	845 x 970 x 370

Easy and quick installation and maintenance

Serviceability & Workability

Quick positioning !

Indoor unit is easily positioned and installed

1 Adjustable easier positioning of unit by new slits. FDT

New shape of slit is suitable to install the unit with more flexibility, according to many kinds of suspending bolt pitch on site. Any rectangular or squared pitch of suspending bolts are available with this slit.

Compatible with both square or rectangular bolt pitch

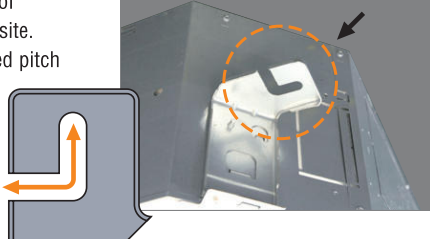

2 New slit in panel allows easier installation on site. FDT
FDTC

Flexible positioning is available, which helps adjusting the direction of panel according to lines or pattern on the ceiling.

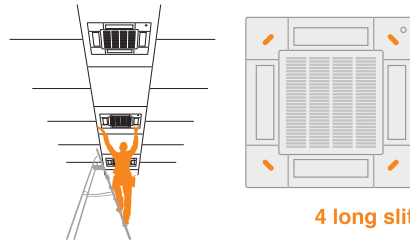

4 long slits are available.

Quick installation and maintenance

1 Easy access to component part for easy maintenance. FDT

1. The control box and bell mouth can be removed together.

2. Easy access to impeller and fan motor.

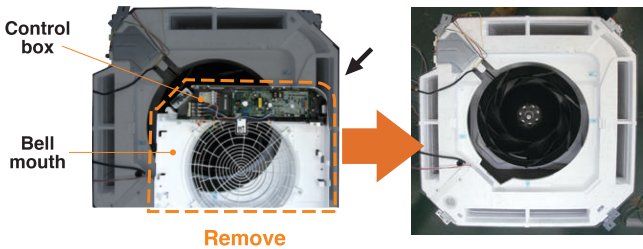

2 New shape of path of wiring. FDT

New shape of path gives easy wiring work for installation.

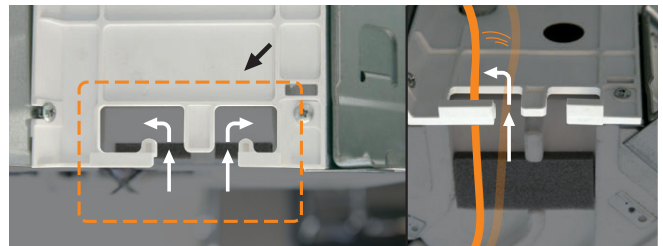

Easy wiring work

3 No need to remove screws to open the controller cover. FDT

It is possible to loose and slide open the cover without remove of the screws. This prevents the cover from falling and damaging to stuffs on site.

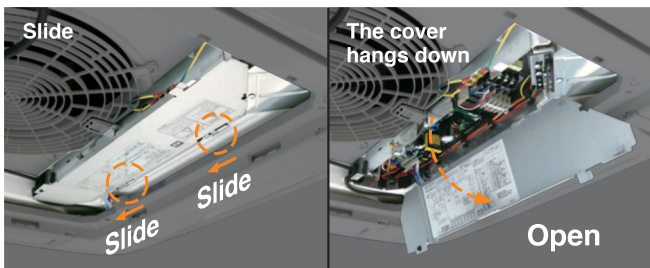

No need to remove screws



4 Safer installation by stopper of washer FDT
FDTC

When unit is installed with hook between washers, this stopper helps to install the unit safely, without adjusting washer.

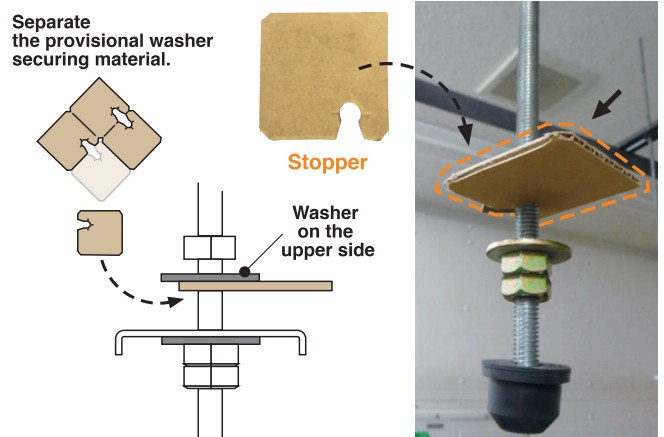



Builder



Maintenance



FDT



FDTC

For smooth and easy working

Good help for installation and maintenance

1 Easy and flexible hook to remove the filter

FDT
FDTC

Hook of soft material helps to remove the filter without dust spreading.

Press the filter tab to the outside and remove the filter.

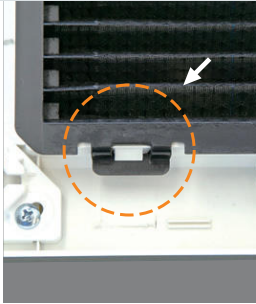

Soft material

2 Securely fix the corner lid by strap

FDT

The direction of the strap hook part has been changed from longitudinal to lateral. Furthermore, a barb has been added to the hook pin to prevent the strap from coming off.

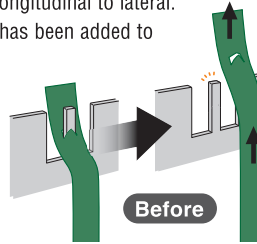

Before



After

Easy to hook but not easy to loose

3 Drain-up-lift increases up to 850 mm

FDT
FDTC

The drain can be lifted up to 850 mm from the ceiling surface.

	Previous	New
FDT	700	850
FDTC	600	850

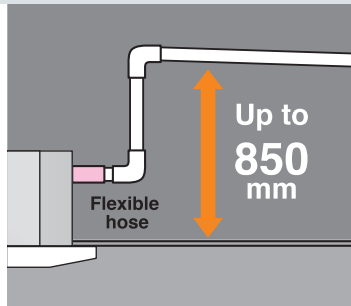

Up to 850 mm

4 New port to check drain water flow

FDT

A water supply port has been provided in the piping lid for easier testing of the drain water flow. (The port is usually sealed with a rubber cap.)

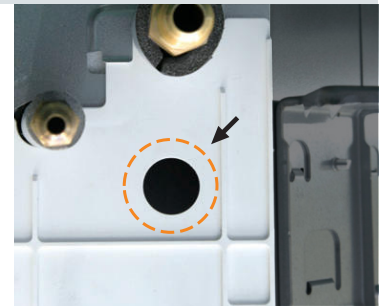

5 Re-use of packages during construction work

FDT
FDTC

Package material (carton) help to protect the unit from unexpected welding spatter or coming dust to the new unit.

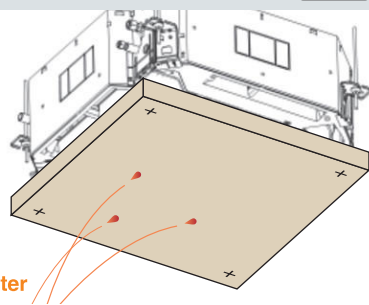

Spatter

6 More flexible outlet for ducting

FDT
FDTC

Both $\phi 125$ and $\phi 200$ (oval shaped) are available.

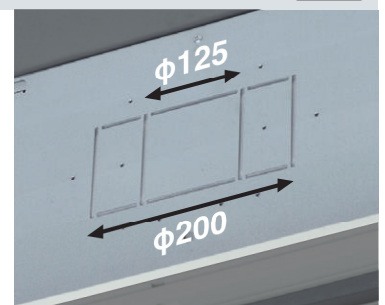
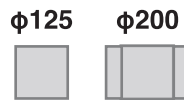

7 Easy check of drain pan

FDT
FDTC

Easy inspection of the condition of the drain pan is possible by removing corner lid only.



FDTC

Remove corner lid. Remove drain cap cover and check the condition. It is necessary to clean-up, firstly remove the rubber stopper to drain water out and secondly remove the drain cap.

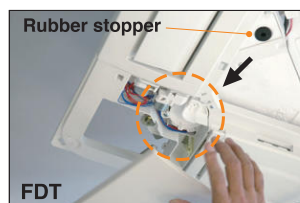

FDT

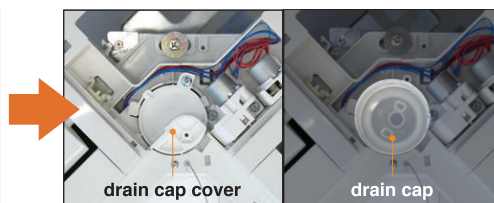

drain cap cover

drain cap

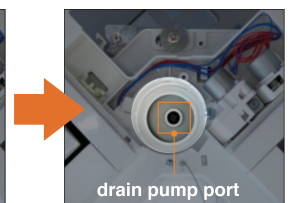

drain pump port

Clean up the area around the drain pump port.

DIMENSIONS (Unit:mm) - FDT -

Models FDT40VH, 50VH, 60VH, 71VH

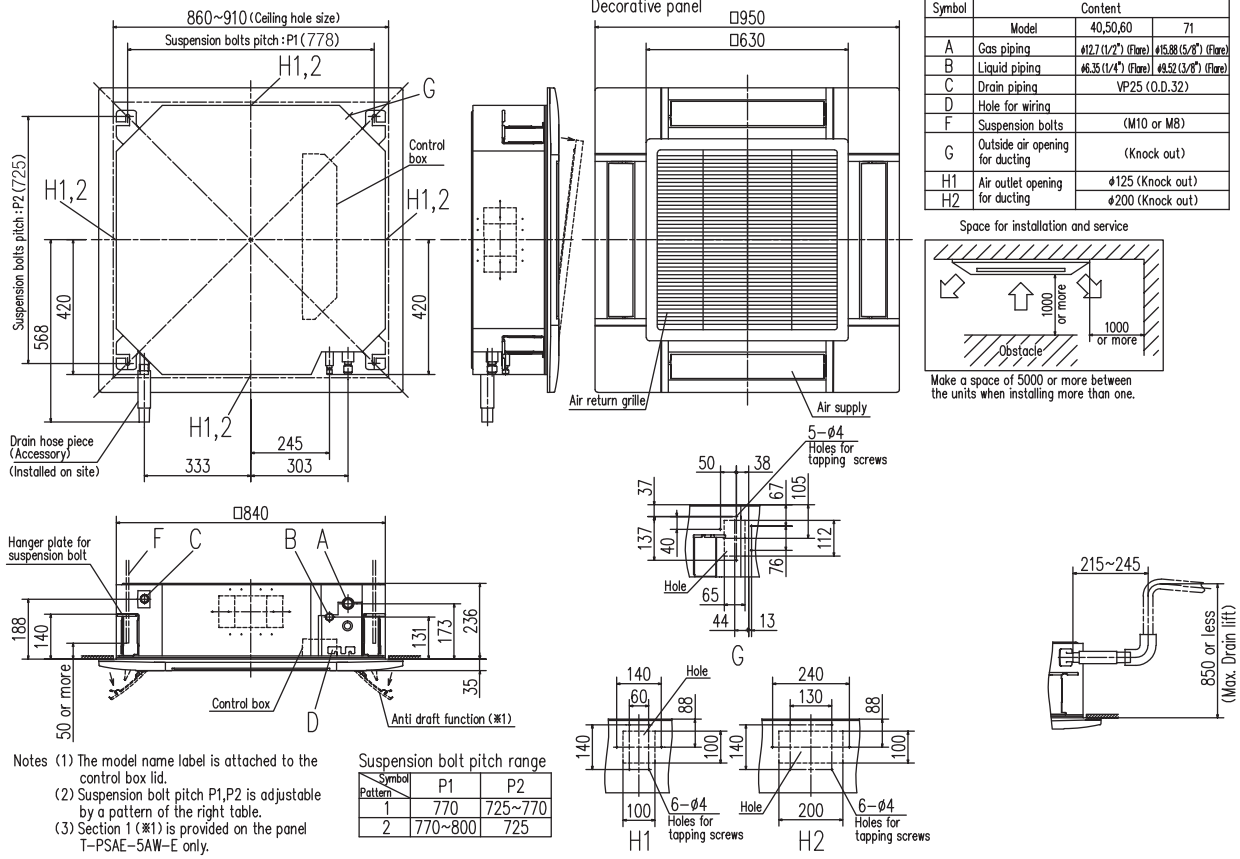

- Notes (1) The model name label is attached to the control box lid.
 (2) Suspension bolt pitch P1,P2 is adjustable by a pattern of the right table.
 (3) Section 1 (*1) is provided on the panel T-PSAE-5AW-E only.

Models FDT100VH, 125VH, 140VH

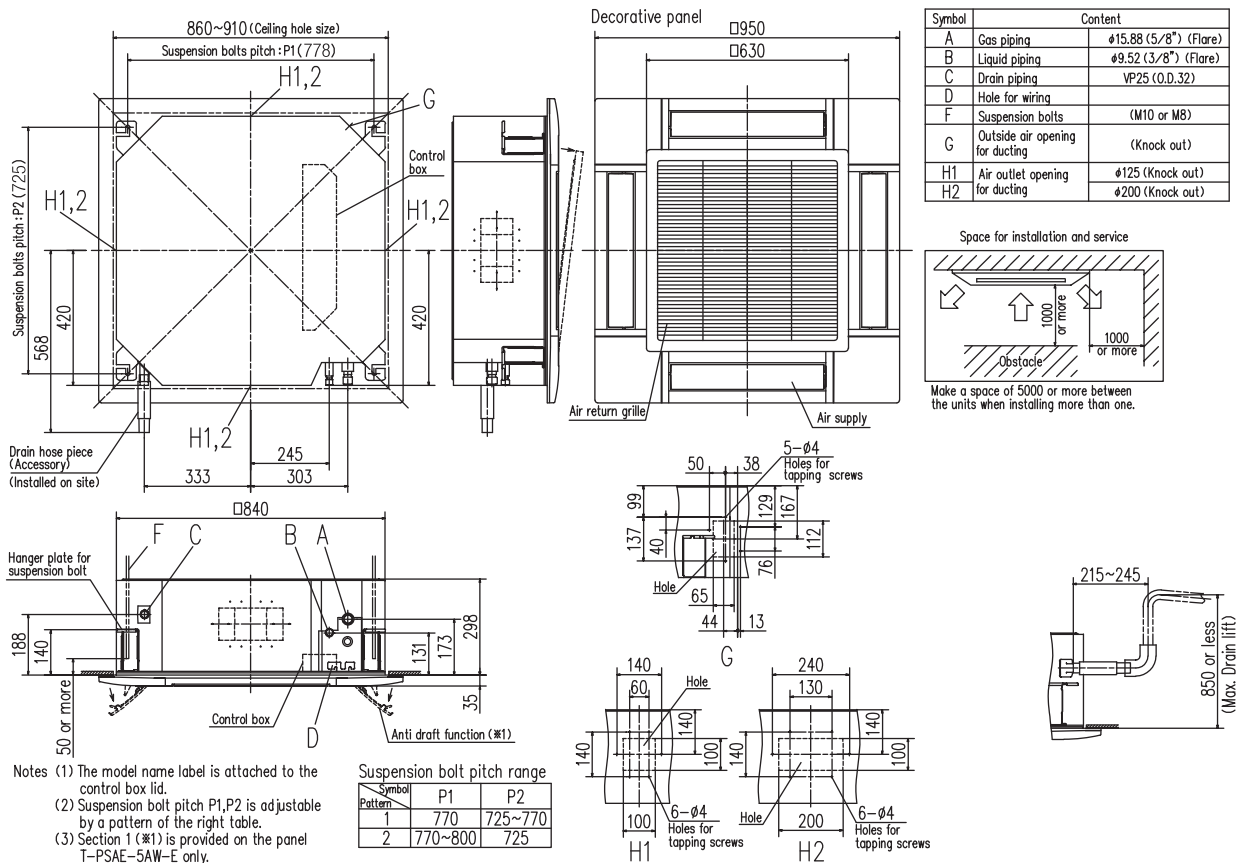

- Notes (1) The model name label is attached to the control box lid.
 (2) Suspension bolt pitch P1,P2 is adjustable by a pattern of the right table.
 (3) Section 1 (*1) is provided on the panel T-PSAE-5AW-E only.

SPECIFICATIONS -FDT-

The values are for simultaneous Multi operation.(except single use)

R32			Hyper Inverter					
Set model name			FDT40ZSXW1VH	FDT50ZSXW1VH	FDT60ZSXW1VH	FDT71VNXWVH	FDT71VNXWPVH	
							Twin	
Indoor unit			FDT40VH	FDT50VH	FDT60VH	FDT71VH	FDT40VH x 2	
Outdoor unit			SRC40ZSX-W1	SRC50ZSX-W1	SRC60ZSX-W1	FDC71VNX-W	FDC71VNX-W	
Power source			1 Phase 220-240V, 50Hz / 220V, 60Hz					
Nominal cooling capacity (Min~Max)			kW 4.0 (1.1 ~ 4.7)	5.0 (1.1 ~ 5.6)	5.6 (1.1 ~ 6.3)	7.1 (3.2 ~ 8.0)	7.1 (3.2 ~ 8.0)	
Nominal heating capacity (Min~Max)			kW 4.5 (0.6 ~ 5.4)	5.4 (0.6 ~ 6.3)	6.7 (0.6 ~ 6.7)	8.0 (3.6 ~ 9.0)	8.0 (3.6 ~ 9.0)	
Power consumption			Cooling/Heating kW 0.890 / 1.03	1.29 / 1.31	1.33 / 1.56	1.69 / 1.75	1.61 / 1.83	
EER/COP			Cooling/Heating 4.49 / 4.37	3.88 / 4.12	4.21 / 4.29	4.20 / 4.58	4.40 / 4.38	
Inrush current			A	5	5	5	5	
Max. current				15	15	15	19.1	
Sound power level*1	Indoor	Cooling/Heating	50 / 50	55 / 56	58 / 59	64 / 64	55 / 55	
	Outdoor	Cooling/Heating	63 / 62	63 / 62	65 / 65	66 / 66	66 / 66	
Sound pressure level*1	Indoor	Cooling (P-Hi/Hi/Me/Lo)	dB(A)	36 / 33 / 30 / 26	41 / 33 / 30 / 26	44 / 34 / 30 / 27	46 / 35 / 33 / 31	39 / 33 / 31 / 30
		Heating (P-Hi/Hi/Me/Lo)		36 / 33 / 28 / 20	42 / 33 / 28 / 20	44 / 34 / 30 / 23	46 / 35 / 33 / 31	39 / 33 / 31 / 30
	Outdoor	Cooling/Heating		52 / 50	52 / 50	53 / 54	51 / 51	51 / 51
		Cooling (P-Hi/Hi/Me/Lo)		19 / 16 / 13 / 10	22 / 16 / 13 / 10	26 / 17 / 14 / 11	28 / 21 / 19 / 17	20 / 18 / 16 / 14
Air flow	Indoor	Heating (P-Hi/Hi/Me/Lo)	m³/min	19 / 16 / 13 / 10	22 / 16 / 13 / 10	26 / 17 / 14 / 11	28 / 21 / 19 / 17	20 / 18 / 16 / 14
		Cooling/Heating		39 / 33	39 / 33	41.5 / 39	60 / 50	60 / 50
Exterior dimensions	Indoor	HeightxWidthxDepth	mm	Unit: 236 x 840 x 840 Panel: 35 x 950 x 950				
	Outdoor			640 x 800(+71) x 290		750 x 880(+88) x 340		
Net weight	Indoor		kg	24(Unit:19 Standard Panel:5)		26(Unit:21 Standard Panel:5)		
	Outdoor			45		60		
Ref.piping size	Liquid/Gas		ømm	6.35(1/4") / 12.7(1/2")		9.52(3/8") / 15.88(5/8")		
Refrigerant line (one way) length			m	Max.30		Max.50		
Vertical height differences	Outdoor is higher/lower		m	Max.20 / Max.20		Max.30 / Max.15		
Outdoor operating temperature range	Cooling	°C	-15~46*2		-15~50*2			
	Heating		-20~24		-20~20			
Panel	T-PSA-5AW-E, T-PSAE-5AW-E							
Air filter, Q'ty	Pocket plastic net x 1(Washable)							
Remote control (option)	wired:RC-EX3A, RC-E5, RCH-E3 wireless:RCN-T-5AW-E2							

R410A			Hyper Inverter				
Set model name			FDT40ZSXVH	FDT50ZSXVH	FDT60ZSXVH	FDT71VNXVH	
Indoor unit			FDT40VH	FDT50VH	FDT60VH	FDT71VH	
Outdoor unit			SRC40ZSX-S	SRC50ZSX-S	SRC60ZSX-S	FDC71VNX	
Power source			1 Phase 220-240V, 50Hz / 220V, 60Hz				
Nominal cooling capacity (Min~Max)			kW 4.0 (1.1 ~ 4.7)	5.0 (1.1 ~ 5.6)	5.6 (1.1 ~ 6.3)	7.1 (3.2 ~ 8.0)	
Nominal heating capacity (Min~Max)			kW 4.5 (0.6 ~ 5.4)	5.4 (0.6 ~ 6.3)	6.7 (0.6 ~ 7.1)	8.0 (3.6 ~ 9.0)	
Power consumption			Cooling/Heating kW 0.93 / 1.03	1.29 / 1.31	1.52 / 1.56	1.96 / 1.91	
EER/COP			Cooling/Heating 4.30 / 4.37	3.88 / 4.12	3.68 / 4.29	3.62/4.19	
Inrush current			A	5	5	5	5
Max. current				12	15	15	17
Sound power level*1	Indoor	Cooling/Heating	50 / 50	55 / 56	58 / 59	59 / 60	
	Outdoor	Cooling/Heating	63 / 63	63 / 63	65 / 64	66 / 66	
Sound pressure level*1	Indoor	Cooling (P-Hi/Hi/Me/Lo)	dB(A)	36 / 33 / 30 / 26	41 / 33 / 30 / 26	44 / 34 / 30 / 27	46 / 34 / 31 / 26
		Heating (P-Hi/Hi/Me/Lo)		36 / 33 / 28 / 20	42 / 33 / 28 / 20	44 / 34 / 30 / 23	46 / 34 / 31 / 26
	Outdoor	Cooling/Heating		50 / 49	50 / 49	52 / 52	51 / 48
		Cooling (P-Hi/Hi/Me/Lo)		19 / 16 / 13 / 10	22 / 16 / 13 / 10	26 / 17 / 14 / 11	28 / 18 / 15 / 12
Air flow	Indoor	Heating (P-Hi/Hi/Me/Lo)	m³/min	19 / 16 / 13 / 10	22 / 16 / 13 / 10	26 / 17 / 14 / 11	28 / 18 / 15 / 12
		Cooling/Heating		36 / 33	39 / 33	41.5 / 39	60 / 50
Exterior dimensions	Indoor	HeightxWidthxDepth	mm	Unit: 236 x 840 x 840 Panel: 35 x 950 x 950			
	Outdoor			640 x 800(+71) x 290		750 x 880(+88) x 340	
Net weight	Indoor		kg	24(Unit:19 Standard Panel:5)		26(Unit:21 Standard Panel:5)	
	Outdoor			45		60	
Ref.piping size	Liquid/Gas		ømm	6.35(1/4") / 12.7(1/2")		9.52(3/8") / 15.88(5/8")	
Refrigerant line (one way) length			m	Max.30		Max. 50	
Vertical height differences	Outdoor is higher/lower		m	Max.20 / Max.20		Max.30 / Max.15	
Outdoor operating temperature range	Cooling	°C	-15~46*2		-15~43*2		
	Heating		-20~24		-20~20		
Panel	T-PSA-5AW-E, T-PSAE-5AW-E						
Air filter, Q'ty	Pocket plastic net x 1(Washable)						
Remote control (option)	wired:RC-EX3A, RC-E5, RCH-E3 wireless:RCN-T-5AW-E2						

NOTES:

The data are measured under the following conditions(R410A : ISO-T1, R32 : ISO-T1, H1).
 Cooling:Indoor temp. of 27°CDB, 19°CWB, and outdoor temp. of 35°CDB. Heating:Indoor temp. of 20°CDB, and outdoor temp. of 7°CDB, 6°CWB.
 *1 : Indicates the value in an anechoic chamber. During operation these values are somewhat higher due to ambient conditions.
 *2 : If a cooling operation is conducted when the outdoor air temperature is -5°C or lower, the outdoor unit should be installed at a place where it is not influenced by natural wind. If wind blows, the low pressure will drop and compressor frequency will increase, this will cause the capacity to drop and may cause the unit to break down.

SPECIFICATIONS -FDT-

R410A			HyperInverter		
Set model name			FDT100VNXVH	FDT125VNXVH	FDT140VNXVH
Indoor unit			FDT100VH	FDT125VH	FDT140VH
Outdoor unit			FDC100VNX	FDC125VNX	FDC140VNX
Power source			1 Phase 220-240V, 50Hz / 220V, 60Hz		
Nominal cooling capacity (Min~Max)		kW	10.0 (4.0 ~ 11.2)	12.5 (5.0 ~ 14.0)	14.0 (5.0 ~ 16.0)
Nominal heating capacity (Min~Max)		kW	11.2 (4.0 ~ 12.5)	14.0 (4.0 ~ 17.0)	16.0 (4.0 ~ 18.0)
Power consumption	Cooling/Heating	kW	2.50 / 2.58	3.42 / 3.43	4.58 / 4.20
EER/COP	Cooling/Heating		4.00 / 4.34	3.65 / 4.08	3.06 / 3.81
Inrush current		A	5	5	5
Max. current			24	26	26
Sound power level*1	Indoor	Cooling/Heating	62 / 62	63 / 64	63 / 64
	Outdoor	Cooling/Heating	70 / 70	70 / 70	72 / 72
Sound pressure level*1	Indoor	Cooling (P-Hi/Hi/Me/Lo)	47 / 39 / 36 / 30	48 / 41 / 39 / 31	48 / 42 / 39 / 32
		Heating (P-Hi/Hi/Me/Lo)	47 / 39 / 36 / 29	48 / 41 / 38 / 31	48 / 41 / 38 / 31
	Outdoor	Cooling/Heating	48 / 50	48 / 50	49 / 52
		Cooling (P-Hi/Hi/Me/Lo)	37 / 26 / 23 / 17	38 / 28 / 25 / 18	38 / 29 / 26 / 19
Air flow	Indoor	Heating (P-Hi/Hi/Me/Lo)	37 / 26 / 23 / 17	38 / 28 / 25 / 18	38 / 29 / 26 / 19
		Cooling/Heating	100 / 100	100 / 100	100 / 100
Exterior dimensions	Indoor	HeightxWidthxDepth	mm	Unit: 298 x 840 x 840 Panel: 35 x 950 x 950	
	Outdoor			1,300 x 970 x 370	
Net weight	Indoor		kg	30(Unit:25 Standard Panel:5)	
	Outdoor			105	
Ref.piping size	Liquid/Gas	ømm	9.52(3/8") / 15.88(5/8")		
Refrigerant line (one way) length		m	Max.100		
Vertical height differences	Outdoor is higher/lower	m	Max.30 / Max.15		
Outdoor operating temperature range	Cooling	°C	-15~43*2		
	Heating		-20~20		
Panel			T-PSA-5AW-E, T-PSAE-5AW-E		
Air filter, Q'ty			Pocket plastic net x 1(Washable)		
Remote control (option)			wired:RC-EX3A, RC-E5, RCH-E3 wireless:RCN-T-5AW-E2		

R410A			HyperInverter		
Set model name			FDT100VSXVH	FDT125VSXVH	FDT140VSXVH
Indoor unit			FDT100VH	FDT125VH	FDT140VH
Outdoor unit			FDC100VSX	FDC125VSX	FDC140VSX
Power source			3 Phase 380-415V, 50Hz / 380V, 60Hz		
Nominal cooling capacity (Min~Max)		kW	10.0 (4.0 ~ 11.2)	12.5 (5.0 ~ 14.0)	14.0 (5.0 ~ 16.0)
Nominal heating capacity (Min~Max)		kW	11.2 (4.0 ~ 16.0)	14.0 (4.0 ~ 18.0)	16.0 (4.0 ~ 20.0)
Power consumption	Cooling/Heating	kW	2.50 / 2.58	3.42 / 3.43	4.58 / 4.20
EER/COP	Cooling/Heating		4.00 / 4.34	3.65 / 4.08	3.06 / 3.81
Inrush current		A	5	5	5
Max. current			15	15	15
Sound power level*1	Indoor	Cooling/Heating	62 / 62	63 / 64	63 / 64
	Outdoor	Cooling/Heating	70 / 70	70 / 70	72 / 72
Sound pressure level*1	Indoor	Cooling (P-Hi/Hi/Me/Lo)	47 / 39 / 36 / 30	48 / 41 / 39 / 31	48 / 42 / 39 / 32
		Heating (P-Hi/Hi/Me/Lo)	47 / 39 / 36 / 29	48 / 41 / 38 / 31	48 / 41 / 38 / 31
	Outdoor	Cooling/Heating	48 / 50	48 / 50	49 / 52
		Cooling (P-Hi/Hi/Me/Lo)	37 / 26 / 23 / 17	38 / 28 / 25 / 18	38 / 29 / 26 / 19
Air flow	Indoor	Heating (P-Hi/Hi/Me/Lo)	37 / 26 / 23 / 17	38 / 28 / 25 / 18	38 / 29 / 26 / 19
		Cooling/Heating	100 / 100	100 / 100	100 / 100
Exterior dimensions	Indoor	HeightxWidthxDepth	mm	Unit: 298 x 840 x 840 Panel: 35 x 950 x 950	
	Outdoor			1,300 x 970 x 370	
Net weight	Indoor		kg	30(Unit:25 Standard Panel:5)	
	Outdoor			105	
Ref.piping size	Liquid/Gas	ømm	9.52(3/8") / 15.88(5/8")		
Refrigerant line (one way) length		m	Max.100		
Vertical height differences	Outdoor is higher/lower	m	Max.30 / Max.15		
Outdoor operating temperature range	Cooling	°C	-15~43*2		
	Heating		-20~20		
Panel			T-PSA-5AW-E, T-PSAE-5AW-E		
Air filter, Q'ty			Pocket plastic net x 1(Washable)		
Remote control (option)			wired:RC-EX3A, RC-E5, RCH-E3 wireless:RCN-T-5AW-E2		

NOTES:

<p>The data are measured under the following conditions(ISO-T1). Cooling:Indoor temp. of 27°CDB, 19°CWB, and outdoor temp. of 35°CDB. Heating:Indoor temp. of 20°CDB, and outdoor temp. of 7°CDB, 6°CWB. *1 : Indicates the value in an anechoic chamber. During operation these values are somewhat higher due to ambient conditions. *2 : If a cooling operation is conducted when the outdoor air temperature is -5°C or lower, the outdoor unit should be installed at a place where it is not influenced by natural wind. If wind blows, the low pressure will drop and compressor frequency will increase, this will cause the capacity to drop and may cause the unit to break down. *3 : The values are for one indoor unit operation. (Multi system only)</p>
--

The values are for simultaneous Multi operation.

R410A		HyperInverter				
Set model name		FDT71VNXPVH	FDT100VNXPVH	FDT125VNXPVH	FDT140VNXPVH	FDT140VNXTVH
		Twin			Triple	
Indoor unit		FDT40VH x 2	FDT50VH x 2	FDT60VH x 2	FDT71VH x 2	FDT50VH x 3
Outdoor unit		FDC71VNX	FDC100VNX	FDC125VNX	FDC140VNX	FDC140VNX
Power source		1 Phase 220-240V, 50Hz / 220V, 60Hz				
Nominal cooling capacity (Min~Max)	kW	7.1 (3.2 ~ 8.0)	10.0 (4.0 ~ 11.2)	12.5 (5.0 ~ 14.0)	14.0 (5.0 ~ 16.0)	14.0 (5.0 ~ 16.0)
Nominal heating capacity (Min~Max)	kW	8.0 (3.6 ~ 9.0)	11.2 (4.0 ~ 12.5)	14.0 (4.0 ~ 17.0)	16.0 (4.0 ~ 18.0)	16.0 (4.0 ~ 18.0)
Power consumption	Cooling/Heating	1.85 / 1.99	2.56 / 2.67	3.26 / 3.22	3.88 / 3.74	3.93 / 4.00
EER/COP	Cooling/Heating	3.84 / 4.02	3.91 / 4.19	3.83 / 4.35	3.61 / 4.28	3.56 / 4.00
Inrush current		5	5	5	5	5
Max. current		17	24	26	26	26
Sound power level*1	Indoor ⁺³	Cooling/Heating	50 / 50	55 / 56	58 / 59	59 / 60
	Outdoor	Cooling/Heating	66 / 66	70 / 70	70 / 70	72 / 72
Sound pressure level*1	Indoor ⁺³	Cooling (P-Hi/Hi/Me/Lo)	36 / 33 / 30 / 26	41 / 33 / 30 / 26	44 / 34 / 30 / 27	46 / 34 / 31 / 26
		Heating (P-Hi/Hi/Me/Lo)	36 / 33 / 28 / 20	42 / 33 / 28 / 20	44 / 34 / 30 / 23	46 / 34 / 31 / 26
	Outdoor	Cooling/Heating	51 / 48	48 / 50	48 / 50	49 / 52
		Air flow	Cooling (P-Hi/Hi/Me/Lo)	19 / 16 / 13 / 10	22 / 16 / 13 / 10	26 / 17 / 14 / 11
Air flow	Outdoor	Heating (P-Hi/Hi/Me/Lo)	19 / 16 / 13 / 10	22 / 16 / 13 / 10	26 / 17 / 14 / 11	28 / 18 / 15 / 12
		Cooling/Heating	60 / 50	100 / 100	100 / 100	100 / 100
Exterior dimensions	Indoor	HeightxWidthxDepth	Unit: 236 x 840 x 840 Panel: 35 x 950 x 950			
	Outdoor		750 x 880(+88) x 340 1,300 x 970 x 370			
Net weight	Indoor		24(Unit:19 Standard Panel:5)		26(Unit:21 Standard Panel:5)	
	Outdoor		60		105	
Ref.piping size	Liquid/Gas		9.52(3/8") / 15.88(5/8")			
Refrigerant line (one way) length			Max. 50	Max. 100		
Vertical height differences	Outdoor is higher/lower		Max.30 / Max.15			
Outdoor operating temperature range	Cooling		-15~43*2			
	Heating		-20~20			
Panel		T-PSA-5AW-E, T-PSAE-5AW-E				
Air filter, Q'ty		Pocket plastic net x 1(Washable)				
Remote control (option)		wired:RC-EX3A, RC-E5, RCH-E3 wireless:RCN-T-5AW-E2				

The values are for simultaneous Multi operation.

R410A		HyperInverter			
Set model name		FDT100VSXPVH	FDT125VSXPVH	FDT140VSXPVH	FDT140VSXTVH
		Twin			Triple
Indoor unit		FDT50VH x 2	FDT60VH x 2	FDT71VH x 2	FDT50VH x 3
Outdoor unit		FDC100VSX	FDC125VSX	FDC140VSX	FDC140VSX
Power source		3 Phase 380-415V, 50Hz / 380V, 60Hz			
Nominal cooling capacity (Min~Max)	kW	10.0 (4.0 ~ 11.2)	12.5 (5.0 ~ 14.0)	14.0 (5.0 ~ 16.0)	14.0 (5.0 ~ 16.0)
Nominal heating capacity (Min~Max)	kW	11.2 (4.0 ~ 16.0)	14.0 (4.0 ~ 18.0)	16.0 (4.0 ~ 20.0)	16.0 (4.0 ~ 20.0)
Power consumption	Cooling/Heating	2.56 / 2.67	3.26 / 3.22	3.88 / 3.74	3.93 / 4.00
EER/COP	Cooling/Heating	3.91 / 4.19	3.83 / 4.35	3.61 / 4.28	3.56 / 4.00
Inrush current		5	5	5	5
Max. current		15	15	15	15
Sound power level*1	Indoor ⁺³	Cooling/Heating	55 / 56	58 / 59	59 / 60
	Outdoor	Cooling/Heating	70 / 70	70 / 70	72 / 72
Sound pressure level*1	Indoor ⁺³	Cooling (P-Hi/Hi/Me/Lo)	41 / 33 / 30 / 26	44 / 34 / 30 / 27	46 / 34 / 31 / 26
		Heating (P-Hi/Hi/Me/Lo)	42 / 33 / 28 / 20	44 / 34 / 30 / 23	46 / 34 / 31 / 26
	Outdoor	Cooling/Heating	48 / 50	48 / 50	49 / 52
		Air flow	Cooling (P-Hi/Hi/Me/Lo)	22 / 16 / 13 / 10	26 / 17 / 14 / 11
Air flow	Outdoor	Heating (P-Hi/Hi/Me/Lo)	22 / 16 / 13 / 10	26 / 17 / 14 / 11	28 / 18 / 15 / 12
		Cooling/Heating	100 / 100	100 / 100	100 / 100
Exterior dimensions	Indoor	HeightxWidthxDepth	Unit: 236 x 840 x 840 Panel: 35 x 950 x 950		
	Outdoor		1,300 x 970 x 370		
Net weight	Indoor		24(Unit:19 Standard Panel:5)		26(Unit:21 Standard Panel:5)
	Outdoor		60		105
Ref.piping size	Liquid/Gas		9.52(3/8") / 15.88(5/8")		
Refrigerant line (one way) length			Max.100		
Vertical height differences	Outdoor is higher/lower		Max.30 / Max.15		
Outdoor operating temperature range	Cooling		-15~43*2		
	Heating		-20~20		
Panel		T-PSA-5AW-E, T-PSAE-5AW-E			
Air filter, Q'ty		Pocket plastic net x 1(Washable)			
Remote control (option)		wired:RC-EX3A, RC-E5, RCH-E3 wireless:RCN-T-5AW-E2			

SPECIFICATIONS -FDT-

R32		Micro Inverter		
Set model name		FDT100VNAWVH	FDT125VNAWVH	FDT140VNAWVH
Indoor unit		FDT100VH	FDT125VH	FDT140VH
Outdoor unit		FDC100VNA-W	FDC125VNA-W	FDC140VNA-W
Power source		1 Phase 220-240V, 50Hz / 220V, 60Hz		
Nominal cooling capacity (Min~Max)		kW 10.0 (4.0 ~ 11.2)	12.5 (5.0 ~ 14.0)	13.6 (5.0 ~ 14.5)
Nominal heating capacity (Min~Max)		kW 11.2 (4.0 ~ 12.5)	14.0 (4.0 ~ 16.0)	15.5 (4.0 ~ 16.5)
Power consumption		Cooling/Heating kW 2.73 / 2.54	4.05 / 3.59	4.79 / 4.18
EER/COP		Cooling/Heating 3.66 / 4.41	3.09 / 3.90	2.84 / 3.71
Inrush current		A	5	5
Max. current			24	24
Sound power level*1	Indoor	Cooling/Heating	62 / 62	63 / 64
	Outdoor		Cooling/Heating	69 / 70
Sound pressure level*1	Indoor	Cooling (P-Hi/Hi/Me/Lo)	dB(A) 47 / 39 / 36 / 30	48 / 41 / 39 / 31
	Outdoor	Cooling/Heating	54 / 55	54 / 56
			Cooling (P-Hi/Hi/Me/Lo)	37 / 26 / 23 / 17
Air flow	Indoor	Heating (P-Hi/Hi/Me/Lo)	m³/min 37 / 26 / 23 / 17	38 / 28 / 25 / 18
Exterior dimensions	Indoor	HeightxWidthxDepth	mm Unit: 298 x 840 x 840 Panel: 35 x 950 x 950	
	Outdoor		845 x 970 x 370	
Net weight	Indoor		kg 30(Unit:25 Standard Panel:5)	
	Outdoor		77	
Ref.piping size	Liquid/Gas		ømm 9.52(3/8") / 15.88(5/8")	
Refrigerant line (one way) length		m	Max.50	
Vertical height differences		Outdoor is higher/lower	m Max.50 / Max.15	
Outdoor operating temperature range	Cooling	°C	-15~50*2	
	Heating		-20~20	
Panel		T-PSA-5AW-E, T-PSAE-5AW-E		
Air filter, Q'ty		Pocket plastic net x 1(Washable)		
Remote control (option)		wired:RC-EX3A, RC-E5, RCH-E3 wireless:RCN-T-5AW-E2		

R32		Micro Inverter		
Set model name		FDT100VSAWVH	FDT125VSAWVH	FDT140VSAWVH
Indoor unit		FDT100VH	FDT125VH	FDT140VH
Outdoor unit		FDC100VSA-W	FDC125VSA-W	FDC140VSA-W
Power source		3 Phase 380-415V, 50Hz / 380V, 60Hz		
Nominal cooling capacity (Min~Max)		kW 10.0 (4.0 ~ 11.2)	12.5 (5.0 ~ 14.0)	13.6 (5.0 ~ 14.5)
Nominal heating capacity (Min~Max)		kW 11.2 (4.0 ~ 12.5)	14.0 (4.0 ~ 16.0)	15.5 (4.0 ~ 16.5)
Power consumption		Cooling/Heating kW 2.73 / 2.54	4.05 / 3.59	4.79 / 4.18
EER/COP		Cooling/Heating 3.66 / 4.41	3.09 / 3.90	2.84 / 3.71
Inrush current		A	5	5
Max. current			15	15
Sound power level*1	Indoor	Cooling/Heating	62 / 62	63 / 64
	Outdoor		Cooling/Heating	69 / 70
Sound pressure level*1	Indoor	Cooling (P-Hi/Hi/Me/Lo)	dB(A) 47 / 39 / 36 / 30	48 / 41 / 39 / 31
	Outdoor	Cooling/Heating	54 / 55	54 / 56
			Cooling (P-Hi/Hi/Me/Lo)	37 / 26 / 23 / 17
Air flow	Indoor	Heating (P-Hi/Hi/Me/Lo)	m³/min 37 / 26 / 23 / 17	38 / 28 / 25 / 18
Exterior dimensions	Indoor	HeightxWidthxDepth	mm Unit: 298 x 840 x 840 Panel: 35 x 950 x 950	
	Outdoor		845 x 970 x 370	
Net weight	Indoor		kg 30(Unit:25 Standard Panel:5)	
	Outdoor		78	
Ref.piping size	Liquid/Gas		ømm 9.52(3/8") / 15.88(5/8")	
Refrigerant line (one way) length		m	Max.50	
Vertical height differences		Outdoor is higher/lower	m Max.50 / Max.15	
Outdoor operating temperature range	Cooling	°C	-15~50*2	
	Heating		-20~20	
Panel		T-PSA-5AW-E, T-PSAE-5AW-E		
Air filter, Q'ty		Pocket plastic net x 1(Washable)		
Remote control (option)		wired:RC-EX3A, RC-E5, RCH-E3 wireless:RCN-T-5AW-E2		

NOTES:

<p>The data are measured under the following conditions(ISO-T1, H1). Cooling:Indoor temp. of 27°CDB, 19°CWB, and outdoor temp. of 35°CDB. Heating:Indoor temp. of 20°CDB, and outdoor temp. of 7°CDB, 6°CWB. *1 : Indicates the value in an anechoic chamber. During operation these values are somewhat higher due to ambient conditions. *2 : If a cooling operation is conducted when the outdoor air temperature is -5°C or lower, the outdoor unit should be installed at a place where it is not influenced by natural wind. If wind blows, the low pressure will drop and compressor frequency will increase, this will cause the capacity to drop and may cause the unit to break down. *3 : The values are for one indoor unit operation. (Multi system only)</p>
--

The values are for simultaneous Multi operation.

R32		Micro Inverter				
		FDT100VNAWPVH	FDT125VNAWPVH	FDT140VNAWPVH	FDT140VNAWTVH	
Set model name		Twin		Triple		
Indoor unit		FDT50VH x 2	FDT60VH x 2	FDT71VH x 2	FDT50VH x 3	
Outdoor unit		FDC100VNA-W	FDC125VNA-W	FDC140VNA-W	FDC140VNA-W	
Power source		1 Phase 220-240V, 50Hz / 220V, 60Hz				
Nominal cooling capacity (Min~Max)		kW 10.0 (4.0 ~ 11.2)	12.5 (5.0 ~ 14.0)	13.6 (5.0 ~ 14.5)	13.6 (5.0 ~ 14.5)	
Nominal heating capacity (Min~Max)		kW 11.2 (4.0 ~ 12.5)	14.0 (4.0 ~ 16.0)	15.5 (4.0 ~ 16.5)	15.5 (4.0 ~ 16.5)	
Power consumption	Cooling/Heating	kW 2.82 / 2.73	3.79 / 3.31	4.22 / 3.57	4.22 / 3.57	
EER/COP	Cooling/Heating	3.55 / 4.11	3.30 / 4.23	3.22 / 4.34	3.22 / 3.89	
Inrush current	A	5	5	5	5	
Max. current		24	24	24	24	
Sound power level*1	Indoor*3	Cooling/Heating	55 / 55	58 / 59	59 / 60	55 / 56
	Outdoor	Cooling/Heating	69 / 70	71 / 71	72 / 73	72 / 73
Sound pressure level*1	Indoor*3	Cooling (P-Hi/Hi/Me/Lo)	41 / 33 / 30 / 26	44 / 34 / 30 / 27	46 / 34 / 31 / 26	41 / 33 / 30 / 26
		Heating (P-Hi/Hi/Me/Lo)	42 / 33 / 28 / 20	44 / 34 / 30 / 20	46 / 34 / 31 / 26	42 / 33 / 28 / 20
Air flow	Indoor*3	Cooling (P-Hi/Hi/Me/Lo)	22 / 16 / 13 / 10	26 / 17 / 14 / 11	28 / 18 / 15 / 12	22 / 16 / 13 / 10
		Heating (P-Hi/Hi/Me/Lo)	22 / 16 / 13 / 10	26 / 17 / 14 / 11	28 / 18 / 15 / 12	22 / 16 / 13 / 10
	Outdoor	Cooling/Heating	75 / 73	75 / 73	75 / 73	75 / 73
Exterior dimensions	Indoor	HeightxWidthxDepth	Unit: 236 x 840 x 840 Panel: 35 x 950 x 950			
	Outdoor		845 x 970 x 370			
Net weight	Indoor	kg	24(Unit:19 Standard Panel:5)	26(Unit:21 Standard Panel:5)	24(Unit:19 Standard Panel:5)	
	Outdoor		77			
Ref.piping size	Liquid/Gas	ømm	9.52(3/8") / 15.88(5/8")			
Refrigerant line (one way) length		m	Max.50			
Vertical height differences	Outdoor is higher/lower	m	Max.50 / Max.15			
Outdoor operating temperature range	Cooling	°C	-15~50*2			
	Heating		-20~20			
Panel			T-PSA-5AW-E, T-PSAE-5AW-E			
Air filter, Q'ty			Pocket plastic net x 1(Washable)			
Remote control (option)			wired:RC-EX3A, RC-E5, RCH-E3 wireless:RCN-T-5AW-E2			

The values are for simultaneous Multi operation.

R32		Micro Inverter				
		FDT100VSAWPVH	FDT125VSAWPVH	FDT140VSAWPVH	FDT140VSAWTVH	
Set model name		Twin		Triple		
Indoor unit		FDT50VH x 2	FDT60VH x 2	FDT71VH x 2	FDT50VH x 3	
Outdoor unit		FDC100VSA-W	FDC125VSA-W	FDC140VSA-W	FDC140VSA-W	
Power source		3 Phase 380-415V, 50Hz / 380V, 60Hz				
Nominal cooling capacity (Min~Max)		kW 10.0 (4.0 ~ 11.2)	12.5 (5.0 ~ 14.0)	13.6 (5.0 ~ 14.5)	13.6 (5.0 ~ 14.5)	
Nominal heating capacity (Min~Max)		kW 11.2 (4.0 ~ 12.5)	14.0 (4.0 ~ 16.0)	15.5 (4.0 ~ 16.5)	15.5 (4.0 ~ 16.5)	
Power consumption	Cooling/Heating	kW 2.82 / 2.73	3.79 / 3.31	4.22 / 3.57	4.22 / 3.57	
EER/COP	Cooling/Heating	3.55 / 4.11	3.30 / 4.23	3.22 / 4.34	3.22 / 3.88	
Inrush current	A	5	5	5	5	
Max. current		15	15	15	15	
Sound power level*1	Indoor*3	Cooling/Heating	55 / 56	58 / 59	59 / 60	55 / 56
	Outdoor	Cooling/Heating	69 / 70	71 / 71	72 / 73	72 / 73
Sound pressure level*1	Indoor*3	Cooling (P-Hi/Hi/Me/Lo)	41 / 33 / 30 / 26	44 / 34 / 30 / 27	46 / 34 / 31 / 26	41 / 33 / 30 / 26
		Heating (P-Hi/Hi/Me/Lo)	42 / 33 / 28 / 20	44 / 34 / 30 / 20	46 / 34 / 31 / 26	42 / 33 / 28 / 20
Air flow	Indoor*3	Cooling (P-Hi/Hi/Me/Lo)	22 / 16 / 13 / 10	26 / 17 / 14 / 11	28 / 18 / 15 / 12	22 / 16 / 13 / 10
		Heating (P-Hi/Hi/Me/Lo)	22 / 16 / 13 / 10	26 / 17 / 14 / 11	28 / 18 / 15 / 12	22 / 16 / 13 / 10
	Outdoor	Cooling/Heating	75 / 73	75 / 73	75 / 73	75 / 73
Exterior dimensions	Indoor	HeightxWidthxDepth	Unit: 236 x 840 x 840 Panel: 35 x 950 x 950			
	Outdoor		845 x 970 x 370			
Net weight	Indoor	kg	24(Unit:19 Standard Panel:5)	26(Unit:21 Standard Panel:5)	24(Unit:19 Standard Panel:5)	
	Outdoor		78			
Ref.piping size	Liquid/Gas	ømm	9.52(3/8") / 15.88(5/8")			
Refrigerant line (one way) length		m	Max.50			
Vertical height differences	Outdoor is higher/lower	m	Max.50 / Max.15			
Outdoor operating temperature range	Cooling	°C	-15~50*2			
	Heating		-20~20			
Panel			T-PSA-5AW-E, T-PSAE-5AW-E			
Air filter, Q'ty			Pocket plastic net x 1(Washable)			
Remote control (option)			wired:RC-EX3A, RC-E5, RCH-E3 wireless:RCN-T-5AW-E2			

SPECIFICATIONS -FDT-

R410A		Micro Inverter		
Set model name		FDT100VNAVH	FDT125VNAVH	FDT140VNAVH
Indoor unit		FDT100VH	FDT125VH	FDT140VH
Outdoor unit		FDC100VNA	FDC125VNA	FDC140VNA
Power source		1 Phase 220-240V, 50Hz / 220V, 60Hz		
Nominal cooling capacity (Min~Max)		kW 10.0 (4.0 ~ 11.2)	12.5 (5.0 ~ 14.0)	13.6 (5.0 ~ 14.5)
Nominal heating capacity (Min~Max)		kW 11.2 (4.0 ~ 12.5)	14.0 (4.0 ~ 16.0)	15.5 (4.0 ~ 16.5)
Power consumption		Cooling/Heating kW 2.73 / 2.64	4.05 / 3.74	5.09 / 4.43
EER/COP		Cooling/Heating 3.26 / 4.26	3.09 / 3.74	2.67 / 3.50
Inrush current		A	5	5
Max. current			24	24
Sound power level*1	Indoor	Cooling/Heating	62 / 62	63 / 64
	Outdoor		Cooling/Heating	70 / 70
Sound pressure level*1	Indoor	Cooling (P-Hi/Hi/Me/Lo)	dB(A) 47 / 39 / 36 / 30	48 / 41 / 39 / 31
	Outdoor	Cooling/Heating	54 / 56	55 / 57
			Heating (P-Hi/Hi/Me/Lo)	57 / 59
Air flow	Indoor	Cooling (P-Hi/Hi/Me/Lo)	m³/min 37 / 26 / 23 / 17	38 / 28 / 25 / 18
	Outdoor	Cooling/Heating	75 / 73	75 / 73
Exterior dimensions	Indoor	HeightxWidthxDepth	mm Unit: 298 x 840 x 840 Panel: 35 x 950 x 950	
	Outdoor		845 x 970 x 370	
Net weight	Indoor		kg 30(Unit:25 Standard Panel:5)	
	Outdoor		80	
Ref.piping size	Liquid/Gas	ømm	9.52(3/8") / 15.88(5/8")	
Refrigerant line (one way) length		m	Max.50	
Vertical height differences		Outdoor is higher/lower	m Max.50 / Max.15	
Outdoor operating temperature range	Cooling	°C	-15~50*2	
	Heating		-20~20	
Panel		T-PSA-5AW-E, T-PSAE-5AW-E		
Air filter, Q'ty		Pocket plastic net x 1(Washable)		
Remote control (option)		wired:RC-EX3A, RC-E5, RCH-E3 wireless:RCN-T-5AW-E2		

R410A		Micro Inverter		
Set model name		FDT100VSAVH	FDT125VSAVH	FDT140VSAVH
Indoor unit		FDT100VH	FDT125VH	FDT140VH
Outdoor unit		FDC100VSA	FDC125VSA	FDC140VSA
Power source		3 Phase 380-415V, 50Hz / 380V, 60Hz		
Nominal cooling capacity (Min~Max)		kW 10.0 (4.0 ~ 11.2)	12.5 (5.0 ~ 14.0)	13.6 (5.0 ~ 14.5)
Nominal heating capacity (Min~Max)		kW 11.2 (4.0 ~ 12.5)	14.0 (4.0 ~ 16.0)	15.5 (4.0 ~ 16.5)
Power consumption		Cooling/Heating kW 2.73 / 2.63	4.05 / 3.74	5.09 / 4.43
EER/COP		Cooling/Heating 3.66 / 4.26	3.09 / 3.74	2.67 / 3.50
Inrush current		A	5	5
Max. current			15	15
Sound power level*1	Indoor	Cooling/Heating	62 / 62	63 / 64
	Outdoor		Cooling/Heating	70 / 70
Sound pressure level*1	Indoor	Cooling (P-Hi/Hi/Me/Lo)	dB(A) 47 / 39 / 36 / 30	48 / 41 / 39 / 31
	Outdoor	Cooling/Heating	54 / 56	55 / 57
			Heating (P-Hi/Hi/Me/Lo)	57 / 59
Air flow	Indoor	Cooling (P-Hi/Hi/Me/Lo)	m³/min 37 / 26 / 23 / 17	38 / 28 / 25 / 18
	Outdoor	Cooling/Heating	75 / 73	75 / 73
Exterior dimensions	Indoor	HeightxWidthxDepth	mm Unit: 298 x 840 x 840 Panel: 35 x 950 x 950	
	Outdoor		845 x 970 x 370	
Net weight	Indoor		kg 30(Unit:25 Standard Panel:5)	
	Outdoor		82	
Ref.piping size	Liquid/Gas	ømm	9.52(3/8") / 15.88(5/8")	
Refrigerant line (one way) length		m	Max.50	
Vertical height differences		Outdoor is higher/lower	m Max.50 / Max.15	
Outdoor operating temperature range	Cooling	°C	-15~50*2	
	Heating		-20~20	
Panel		T-PSA-5AW-E, T-PSAE-5AW-E		
Air filter, Q'ty		Pocket plastic net x 1(Washable)		
Remote control (option)		wired:RC-EX3A, RC-E5, RCH-E3 wireless:RCN-T-5AW-E2		

NOTES:

<p>The data are measured under the following conditions(ISO-T1). Cooling:Indoor temp. of 27°CDB, 19°CWB, and outdoor temp. of 35°CDB. Heating:Indoor temp. of 20°CDB, and outdoor temp. of 7°CDB, 6°CWB. *1 : Indicates the value in an anechoic chamber. During operation these values are somewhat higher due to ambient conditions. *2 : If a cooling operation is conducted when the outdoor air temperature is -5°C or lower, the outdoor unit should be installed at a place where it is not influenced by natural wind. If wind blows, the low pressure will drop and compressor frequency will increase, this will cause the capacity to drop and may cause the unit to break down. *3 : The values are for one indoor unit operation. (Multi system only)</p>
--

The values are for simultaneous Multi operation.

R410A		Micro Inverter			
Set model name		FDT100VNAPVH	FDT125VNAPVH	FDT140VNAPVH	FDT140VNATVH
		Twin		Triple	
Indoor unit		FDT50VH x 2	FDT60VH x 2	FDT71VH x 2	FDT50VH x 3
Outdoor unit		FDC100VNA	FDC125VNA	FDC140VNA	FDC140VNA
Power source		1 Phase 220-240V, 50Hz / 220V, 60Hz			
Nominal cooling capacity (Min~Max)	kW	10.0 (4.0 ~ 11.2)	12.5 (5.0 ~ 14.0)	13.6 (5.0 ~ 14.5)	13.6 (5.0 ~ 14.5)
Nominal heating capacity (Min~Max)	kW	11.2 (4.0 ~ 12.5)	14.0 (4.0 ~ 16.0)	15.5 (4.0 ~ 16.5)	15.5 (4.0 ~ 16.5)
Power consumption	Cooling/Heating	2.82 / 2.90	3.79 / 3.31	4.22 / 3.72	4.22 / 3.29
EER/COP	Cooling/Heating	3.55 / 3.86	3.30 / 4.23	3.22 / 4.17	3.22 / 4.71
Inrush current		5	5	5	5
Max. current		24	24	24	24
Sound power level*1	Indoor*3	Cooling/Heating	55 / 56	58 / 59	59 / 60
	Outdoor	Cooling/Heating	70 / 70	71 / 71	73 / 73
Sound pressure level*1	Indoor*3	Cooling (P-Hi/Hi/Me/Lo)	41 / 33 / 30 / 26	44 / 34 / 30 / 27	46 / 34 / 31 / 26
		Heating (P-Hi/Hi/Me/Lo)	42 / 33 / 28 / 20	44 / 34 / 30 / 23	46 / 34 / 31 / 26
Air flow	Indoor*3	Cooling (P-Hi/Hi/Me/Lo)	22 / 16 / 13 / 10	26 / 17 / 14 / 11	28 / 18 / 15 / 12
		Heating (P-Hi/Hi/Me/Lo)	22 / 16 / 13 / 10	26 / 17 / 14 / 11	28 / 18 / 15 / 12
	Outdoor	Cooling/Heating	75 / 73	75 / 73	75 / 73
Exterior dimensions	Indoor	HeightxWidthxDepth	Unit: 236 x 840 x 840 Panel: 35 x 950 x 950		
	Outdoor		845 x 970 x 370		
Net weight	Indoor		24(Unit:19 Standard Panel:5)	26(Unit:21 Standard Panel:5)	24(Unit:19 Standard Panel:5)
	Outdoor		80		
Ref.piping size	Liquid/Gas	ømm	9.52(3/8") / 15.88(5/8")		
Refrigerant line (one way) length		m	Max.50		
Vertical height differences	Outdoor is higher/lower	m	Max.50 / Max.15		
Outdoor operating temperature range	Cooling	°C	-15~50*2		
	Heating		-20~20		
Panel			T-PSA-5AW-E, T-PSAE-5AW-E		
Air filter, Q'ty			Pocket plastic net x 1(Washable)		
Remote control (option)			wired:RC-EX3A, RC-E5, RCH-E3 wireless:RCN-T-5AW-E2		

The values are for simultaneous Multi operation.

R410A		Micro Inverter		
Set model name		FDT100VSAPVH	FDT125VSAPVH	FDT140VSAPVH
		Twin		
Indoor unit		FDT50VH x 2	FDT60VH x 2	FDT71VH x 2
Outdoor unit		FDC100VSA	FDC125VSA	FDC140VSA
Power source		3 Phase 380-415V, 50Hz / 380V, 60Hz		
Nominal cooling capacity (Min~Max)	kW	10.0 (4.0 ~ 11.2)	12.5 (5.0 ~ 14.0)	13.6 (5.0 ~ 14.5)
Nominal heating capacity (Min~Max)	kW	11.2 (4.0 ~ 12.5)	14.0 (4.0 ~ 16.0)	15.5 (4.0 ~ 16.5)
Power consumption	Cooling/Heating	2.82 / 2.90	3.79 / 3.31	4.22 / 3.72
EER/COP	Cooling/Heating	3.55 / 3.86	3.30 / 4.23	3.22 / 4.17
Inrush current		5	5	5
Max. current		15	15	15
Sound power level*1	Indoor*3	Cooling/Heating	55 / 56	58 / 59
	Outdoor	Cooling/Heating	70 / 70	71 / 71
Sound pressure level*1	Indoor*3	Cooling (P-Hi/Hi/Me/Lo)	41 / 33 / 30 / 26	44 / 34 / 30 / 27
		Heating (P-Hi/Hi/Me/Lo)	42 / 33 / 28 / 20	44 / 34 / 30 / 23
Air flow	Indoor*3	Cooling (P-Hi/Hi/Me/Lo)	22 / 16 / 13 / 10	26 / 17 / 14 / 11
		Heating (P-Hi/Hi/Me/Lo)	22 / 16 / 13 / 10	26 / 17 / 14 / 11
	Outdoor	Cooling/Heating	75 / 73	75 / 73
Exterior dimensions	Indoor	HeightxWidthxDepth	Unit: 236 x 840 x 840 Panel: 35 x 950 x 950	
	Outdoor		845 x 970 x 370	
Net weight	Indoor		24(Unit:19 Standard Panel:5)	26(Unit:21 Standard Panel:5)
	Outdoor		82	
Ref.piping size	Liquid/Gas	ømm	9.52(3/8") / 15.88(5/8")	
Refrigerant line (one way) length		m	Max.50	
Vertical height differences	Outdoor is higher/lower	m	Max.50 / Max.15	
Outdoor operating temperature range	Cooling	°C	-15~50*2	
	Heating		-20~20	
Panel			T-PSA-5AW-E, T-PSAE-5AW-E	
Air filter, Q'ty			Pocket plastic net x 1(Washable)	
Remote control (option)			wired:RC-EX3A, RC-E5, RCH-E3 wireless:RCN-T-5AW-E2	

SPECIFICATIONS -FDT-

The values are for simultaneous Multi operation.

R410A		Micro Inverter		
Set model name		FDT200VSAPVH	FDT250VSAPVH	FDT140VSATVH
		Twin		Triple
Indoor unit		FDT100VH x 2	FDT125VH x 2	FDT50VH x 3
Outdoor unit		FDC200VSA	FDC250VSA	FDC140VSA
Power source		3 Phase 380-415V, 50Hz / 380V, 60Hz		
Nominal cooling capacity (Min~Max)	kW	19.0 (5.2 ~ 22.4)	24.0 (6.9 ~ 28.0)	13.6 (5.0 ~ 14.5)
Nominal heating capacity (Min~Max)	kW	22.4 (3.3 ~ 25.0)	27.0 (5.5 ~ 31.5)	15.5 (4.0 ~ 16.5)
Power consumption	Cooling/Heating	6.25 / 6.02	8.36 / 7.15	4.22 / 3.29
EER/COP	Cooling/Heating	3.04 / 3.72	2.87 / 3.78	3.22 / 4.71
Inrush current		5	5	5
Max. current	A	20	21	15
Sound power level*1	Indoor*3	Cooling/Heating	62 / 62	63 / 64
	Outdoor	Cooling/Heating	72 / 74	73 / 75
Sound pressure level*1	Indoor*3	Cooling (P-Hi/Hi/Me/Lo)	47 / 39 / 36 / 30	48 / 41 / 39 / 31
		Heating (P-Hi/Hi/Me/Lo)	47 / 39 / 36 / 29	48 / 41 / 38 / 31
	Outdoor	Cooling/Heating	58 / 59	59 / 62
Air flow	Indoor*3	Cooling (P-Hi/Hi/Me/Lo)	37 / 26 / 23 / 17	38 / 28 / 25 / 18
		Heating (P-Hi/Hi/Me/Lo)	37 / 26 / 23 / 17	38 / 28 / 25 / 18
	Outdoor	Cooling/Heating	135 / 135	143 / 151
Exterior dimensions	Indoor	HeightxWidthxDepth	Unit: 298 x 840 x 840 Panel: 35 x 950 x 950	
	Outdoor		1,300 x 970 x 370	1,505 x 970 x 370
Net weight	Indoor		30(Unit:25 Standard Panel:5)	
	Outdoor		115	143
Ref.piping size	Liquid/Gas	ømm	9.52(3/8") / 22.22(7/8")	12.7(1/2") / 22.22(7/8")
Refrigerant line (one way) length		m	Max.70	
Vertical height differences	Outdoor is higher/lower	m	Max.30 / Max.15	
Outdoor operating temperature range	Cooling	°C	-15~50*2	
	Heating		-15~20	
Panel			T-PSA-5AW-E, T-PSAE-5AW-E	
Air filter, Q'ty			Pocket plastic net x 1(Washable)	
Remote control (option)			wired:RC-EX3A, RC-E5, RCH-E3 wireless:RCN-T-5AW-E2	

The values are for simultaneous Multi operation.

R410A		Micro Inverter		
Set model name		FDT200VSATVH	FDT200VSADVH	FDT250VSADVH
		Triple	Double Twin	
Indoor unit		FDT71VH x 3	FDT50VH x 4	FDT60VH x 4
Outdoor unit		FDC200VSA	FDC200VSA	FDC250VSA
Power source		3 Phase 380-415V, 50Hz / 380V, 60Hz		
Nominal cooling capacity (Min~Max)	kW	19.0 (5.2 ~ 22.4)	19.0 (5.2 ~ 22.4)	24.0 (6.9 ~ 28.0)
Nominal heating capacity (Min~Max)	kW	22.4 (3.3 ~ 25.0)	22.4 (3.3 ~ 25.0)	27.0 (5.5 ~ 31.5)
Power consumption	Cooling/Heating	6.01 / 5.76	6.26 / 6.15	7.43 / 6.83
EER/COP	Cooling/Heating	3.16 / 3.89	3.04 / 3.64	3.23 / 3.95
Inrush current		5	5	5
Max. current	A	20	20	21
Sound power level*1	Indoor*3	Cooling/Heating	59 / 60	55 / 56
	Outdoor	Cooling/Heating	72 / 74	72 / 74
Sound pressure level*1	Indoor*3	Cooling (P-Hi/Hi/Me/Lo)	46 / 34 / 31 / 26	41 / 33 / 30 / 26
		Heating (P-Hi/Hi/Me/Lo)	46 / 34 / 31 / 26	42 / 33 / 28 / 20
	Outdoor	Cooling/Heating	58 / 59	58 / 59
Air flow	Indoor*3	Cooling (P-Hi/Hi/Me/Lo)	28 / 18 / 15 / 12	22 / 16 / 13 / 10
		Heating (P-Hi/Hi/Me/Lo)	28 / 18 / 15 / 12	22 / 16 / 13 / 10
	Outdoor	Cooling/Heating	135 / 135	135 / 135
Exterior dimensions	Indoor	HeightxWidthxDepth	Unit: 236 x 840 x 840 Panel: 35 x 950 x 950	
	Outdoor		1,300 x 970 x 370	1,505 x 970 x 370
Net weight	Indoor		26(Unit:21 Standard Panel:5)	24(Unit:19 Standard Panel:5)
	Outdoor		115	143
Ref.piping size	Liquid/Gas	ømm	9.52(3/8") / 22.22(7/8")	
Refrigerant line (one way) length		m	Max.70	
Vertical height differences	Outdoor is higher/lower	m	Max.30 / Max.15	
Outdoor operating temperature range	Cooling	°C	-15~50*2	
	Heating		-15~20	
Panel			T-PSA-5AW-E, T-PSAE-5AW-E	
Air filter, Q'ty			Pocket plastic net x 1(Washable)	
Remote control (option)			wired:RC-EX3A, RC-E5, RCH-E3 wireless:RCN-T-5AW-E2	

NOTES:

<p>The data are measured under the following conditions(R410A : ISO-T1, R32 : ISO-T1, H1). Cooling:Indoor temp. of 27°CDB, 19°CWB, and outdoor temp. of 35°CDB. Heating:Indoor temp. of 20°CDB, and outdoor temp. of 7°CDB, 6°CWB. *1 : Indicates the value in an anechoic chamber. During operation these values are somewhat higher due to ambient conditions. *2 : If a cooling operation is conducted when the outdoor air temperature is -5°C or lower, the outdoor unit should be installed at a place where it is not influenced by natural wind. If wind blows, the low pressure will drop and compressor frequency will increase, this will cause the capacity to drop and may cause the unit to break down. *3 : The values are for one indoor unit operation. (Multi system only)</p>
--

 R32		Standard Inverter		
Set model name		FDT71VNPVH	FDT90VNPVH	FDT100VNPVH
Indoor unit		FDT71VH	FDT100VH	FDT100VH
Outdoor unit		FDC71VNP-W	FDC90VNP-W	FDC100VNP-W
Power source		1 Phase 220-240V, 50Hz / 220V, 60Hz		
Nominal cooling capacity (Min-Max)		kW 7.1 (1.5 ~ 7.3)	9.0 (2.1 ~ 9.5)	10.0 (2.1 ~ 10.2)
Nominal heating capacity (Min-Max)		kW 7.1 (1.1 ~ 7.3)	9.0 (1.7 ~ 9.5)	10.0 (1.7 ~ 10.4)
Power consumption		Cooling/Heating kW 2.31 / 1.73	2.48 / 1.90	2.84 / 2.33
EER/COP		Cooling/Heating 3.07 / 4.10	3.63 / 4.74	3.52 / 4.29
Inrush current		A 5	5	5
Max. current		15.8	19	19
Sound power level*1	Indoor	Cooling/Heating 59 / 60	62 / 62	62 / 62
	Outdoor	Cooling/Heating 67 / 67	67 / 66	68 / 67
Sound pressure level*1	Indoor	Cooling (P-Hi/Hi/Me/Lo) dB(A) 46 / 34 / 31 / 26	47 / 39 / 36 / 30	47 / 39 / 36 / 30
		Heating (P-Hi/Hi/Me/Lo) 46 / 34 / 31 / 26	47 / 39 / 36 / 29	47 / 39 / 36 / 29
	Outdoor	Cooling/Heating 54 / 54	55 / 53	56 / 54
		Cooling (P-Hi/Hi/Me/Lo) m³/min 28 / 18 / 15 / 12	37 / 26 / 23 / 17	36 / 26 / 23 / 17
Air flow	Indoor	Heating (P-Hi/Hi/Me/Lo) 28 / 18 / 15 / 12	37 / 26 / 23 / 17	36 / 26 / 23 / 17
		Outdoor	Cooling/Heating 42 / 42	59 / 55
Exterior dimensions	Indoor	HeightxWidthxDepth mm Unit: 236 x 840 x 840 Panel: 35 x 950 x 950	Unit: 298 x 840 x 840 Panel: 35 x 950 x 950	
	Outdoor	640 x 800(+71) x 290	750 x 880(+88) x 340	
Net weight	Indoor	kg 26(Unit:21 Standard Panel:5)	30(Unit:25 Standard Panel:5)	
	Outdoor	45	57	
Ref.piping size		Liquid/Gas ømm 6.35(1/4") / 12.7(1/2")	6.35(1/4") / 15.88(5/8")	
Refrigerant line (one way) length		m	Max.30	
Vertical height differences		Outdoor is higher/lower m	Max.20 / Max.20	
Outdoor operating temperature range		Cooling °C	-15~-46*2	
		Heating	-15~-20	
Panel		T-PSA-5AW-E, T-PSAE-5AW-E		
Air filter, Q'ty		Pocket Plastic net x1(Washable)		
Remote control (option)		wired:RC-EX3A, RC-E5, RCH-E3 wireless:RCN-T-5AW-E2		

 R410A		Standard Inverter		
Set model name		FDT71VNPVH	FDT90VNP1VH	FDT100VNP1VH
Indoor unit		FDT71VH	FDT100VH	FDT100VH
Outdoor unit		FDC71VNP	FDC90VNP1	FDC100VNP
Power source		1 Phase 220-240V, 50Hz / 220V, 60Hz		
Nominal cooling capacity (Min-Max)		kW 7.1 (1.4 ~ 7.1)	9.0 (1.9 ~ 9.0)	10.0 (2.8 ~ 11.2)
Nominal heating capacity (Min-Max)		kW 7.1 (1.0 ~ 7.1)	9.0 (1.5 ~ 9.0)	11.2 (2.5 ~ 12.5)
Power consumption		Cooling/Heating kW 2.31 / 1.73	2.67 / 2.19	2.76 / 2.84
EER/COP		Cooling/Heating 3.07 / 4.10	3.37 / 4.11	3.62 / 3.94
Inrush current		A 5	5	5
Max. current		14.5	18	21
Sound power level*1	Indoor	Cooling/Heating 59 / 60	62 / 62	62 / 62
	Outdoor	Cooling/Heating 67 / 67	69 / 69	70 / 70
Sound pressure level*1	Indoor	Cooling (P-Hi/Hi/Me/Lo) dB(A) 46 / 34 / 31 / 26	47 / 39 / 36 / 30	47 / 39 / 36 / 30
		Heating (P-Hi/Hi/Me/Lo) 46 / 34 / 31 / 26	47 / 39 / 36 / 29	47 / 39 / 36 / 29
	Outdoor	Cooling/Heating 54 / 54	57 / 55	57 / 61
		Cooling (P-Hi/Hi/Me/Lo) m³/min 28 / 18 / 15 / 12	37 / 26 / 23 / 17	37 / 26 / 23 / 17
Air flow	Indoor	Heating (P-Hi/Hi/Me/Lo) 28 / 18 / 15 / 12	37 / 26 / 23 / 17	37 / 26 / 23 / 17
		Outdoor	Cooling/Heating 36 / 36	63 / 49.5
Exterior dimensions	Indoor	HeightxWidthxDepth mm Unit: 236 x 840 x 840 Panel: 35 x 950 x 950	Unit: 298 x 840 x 840 Panel: 35 x 950 x 950	
	Outdoor	640 x 800(+71) x 290	750 x 880(+88) x 340	845 x 970 x 370
Net weight	Indoor	kg 26(Unit:21 Standard Panel:5)	30(Unit:25 Standard Panel:5)	
	Outdoor	45	57	70
Ref.piping size		Liquid/Gas ømm 6.35(1/4") / 12.7(1/2")	6.35(1/4") / 15.88(5/8")	9.52(3/8") / 15.88(5/8")
Refrigerant line (one way) length		m	Max.30	
Vertical height differences		Outdoor is higher/lower m	Max.20 / Max.20	
Outdoor operating temperature range		Cooling °C	-15~-46*2	
		Heating	-15~-20	
Panel		T-PSA-5AW-E, T-PSAE-5AW-E		
Air filter, Q'ty		Pocket Plastic net x1(Washable)		
Remote control (option)		wired:RC-EX3A, RC-E5, RCH-E3 wireless:RCN-T-5AW-E2		