



## **SERVICE MANUAL**

# **STANDARD INVERTER PACKAGED AIR-CONDITIONERS** (Split system, air to air heat pump type)

### **CEILING CASSETTE-4 WAY TYPE**

FDT90VNPWVH  
100VNPWVH

### **DUCT CONNECTED-HIGH STATIC PRESSURE TYPE**

FDU90VNPWVH  
100VNPWVH

### **DUCT CONNECTED-LOW/MIDDLE STATIC PRESSURE TYPE**

FDUM90VNPWVH  
100VNPWVH

### **CEILING SUSPENDED TYPE**

FDE90VNPWVH  
100VNPWVH

### **WALL MOUNTED TYPE**

SRK100VNPWZR

## TABLE OF CONTENTS

<b>1. OUTLINE OF OPERATION CONTROL BY MICROCOMPUTER</b> .....	3
<b>1.1 Remote control (Option parts)</b> .....	3
<b>1.2 Operation control function by the wired remote control</b> .....	7
<b>1.3 Operation control function by the indoor control</b> .....	10
<b>1.4 Operation control function by the outdoor control</b> .....	39
(1) Compressor speed .....	39
(2) Compressor protection start .....	39
(3) Outdoor fan control .....	39
(4) Defrost operation .....	41
(5) Cooling overload protective control .....	42
(6) Cooling high pressure control .....	42
(7) Cooling low outdoor temperature protective control .....	43
(8) Heating high pressure control .....	43
(9) Heating overload protective control .....	44
(10) Heating low outdoor temperature protective control .....	44
(11) Compressor overheat protection .....	44
(12) Current safe .....	45
(13) Current cut .....	45
(14) Outdoor unit failure .....	45
(15) Serial signal transmission error protection .....	45
(16) Rotor lock .....	45
(17) Refrigeration cycle system protection .....	45
(18) Silent mode .....	46
(19) Broken wire detection on temperature sensor .....	46
<b>2. MAINTENANCE DATA</b> .....	47
<b>2.1 FDT, FDU, FDUM, FDE series</b> .....	47
<b>2.1.1 Diagnosing of microcomputer circuit</b> .....	47
(1) Selfdiagnosis function .....	47
(2) Troubleshooting procedure .....	50
(3) Troubleshooting at the indoor unit .....	50
(4) Troubleshooting at the outdoor unit .....	56
(5) Check of anomalous operation data with the remote control .....	60
(6) Power transistor module (Including the driver PCB) inspection procedure ...	62
(7) Inverter checker for diagnosis of inverter output .....	63
(8) Outdoor unit control failure diagnosis circuit diagram .....	64
<b>2.1.2 Troubleshooting flow</b> .....	65
(1) List of troubles .....	65
(2) Troubleshooting .....	66

<b>2.2 SRK series</b> .....	109
(1) Cautions .....	109
(2) Items to check before troubleshooting .....	109
(3) Troubleshooting procedure (If the air-conditioner does not run at all) .....	109
(4) Troubleshooting procedure (If the air-conditioner runs) .....	110
(5) Self-diagnosis table .....	111
(6) Service mode (Trouble mode access function) .....	112
(7) Inspection procedures corresponding to detail of trouble .....	120
(8) Phenomenon observed after short-circuit, wire breakage on sensor .....	122
(9) Checking the indoor electrical equipment .....	122
(10) How to make sure of wireless remote control .....	124
(11) Inspection procedure for blown fuse on the indoor unit PCB .....	124
<b>3. ELECTRICAL WIRING</b> .....	125
(1) Indoor units .....	125
(2) Outdoor units .....	130
<b>4. PIPING SYSTEM</b> .....	131

# 1. OUTLINE OF OPERATION CONTROL BY MICROCOMPUTER

## 1.1 Remote control (Option parts)

### (1) Wired remote control

#### Model RC-EX3A

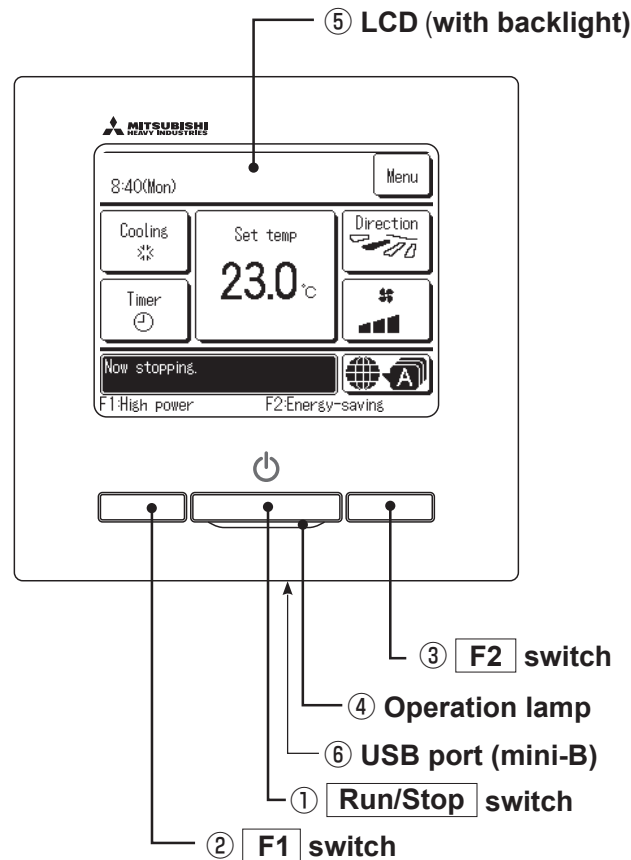

Touch panel system, which is operated by tapping the LCD screen with a finger, is employed for any operations other than the ①Run/Stop, ②F1 and ③F2 switches.

#### ① Run/Stop switch

One push on the button starts operation and another push stops operation.

If the backlight is ON setting, when the screen is tapped while the backlight is turned off, the backlight only is turned on. (Operations with switches ①, ② and ③ are excluded.)

#### ② F1 switch ③ F2 switch

This switch starts operation that is set in F1/F2 function change.

#### ⑥ USB port

USB connector (mini-B) allows connecting to a personal computer.

#### ④ Operation lamp

This lamp lights in green (yellow-green) during operation. It changes to red (orange) if any error occurs.  
Operation lamp luminance can be changed.

For operating methods, refer to the instruction manual attached to the software for personal computer (remote control utility software).

#### ⑤ LCD (with backlight)

A tap on the LCD lights the backlight.  
The backlight turns off automatically if there is no operation for certain period of time.  
Lighting period of the backlight lighting can be changed.

Note(1) When connecting to a personal computer, do not connect simultaneously with other USB devices.  
Please be sure to connect to the computer directly, without going through a hub, etc.

**Model RC-E5**

The figure below shows the remote control with the cover opened. Note that all the items that may be displayed in the liquid crystal display area are shown in the figure for the sake of explanation. Characters displayed with dots in the liquid crystal display area are abbreviated.

The figure below shows the remote control with the cover opened.

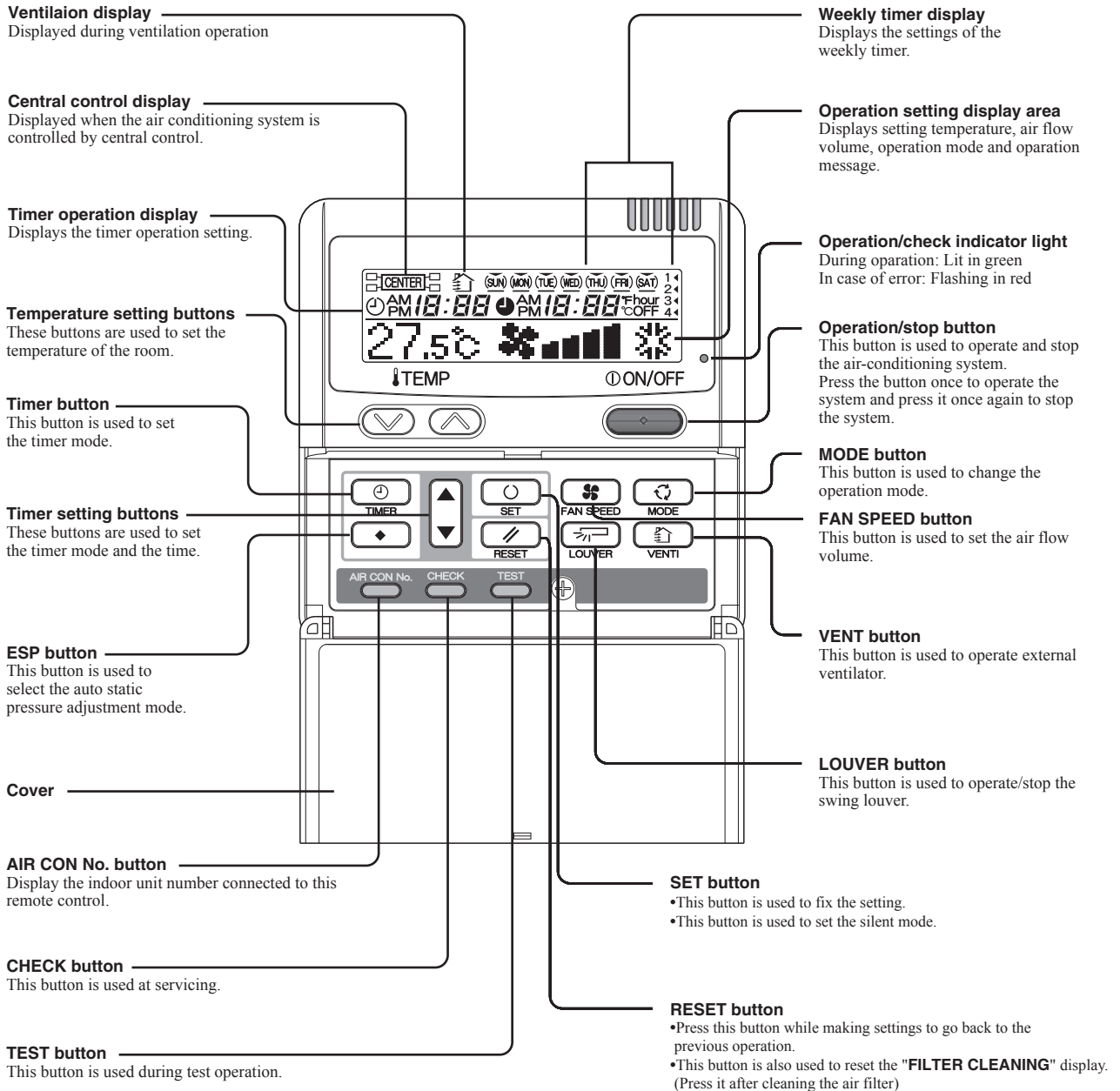

\* All displays are described in the liquid crystal display for explanation.

(2) Wireless remote control

(a) RCN-E2 (Except SRK series)

Indication section

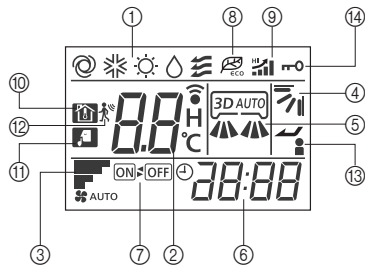

①	OPERATION MODE display	Indicates selected operation mode.
	SET TEMP display	Indicates set temperature.
②	SLEEP TIMER time display	Indicates the amount of time remaining on the sleep timer.
	Indoor function setting number display	Indicates the setting number of the indoor function setting.
③	FAN SPEED display	Indicates the selected air flow volume.
④	UP/DOWN AIR FLOW display	Indicates the up/down louver position.
⑤	LEFT/RIGHT AIR FLOW display	Indicates the left/right louver position.
⑥	Clock display	Indicates the current time. If the timer is set, the ON TIMER and OFF TIMER setting times are indicated.
⑦	ON/OFF TIMER display	Displayed when the timer is set.
⑧	ECO mode display	Displayed when the energy-saving operation is active.
⑨	HI POWER display	Displayed when the high power operation is active.
⑩	NIGHT SETBACK display	Displayed when the home leave mode is active.
⑪	SILENT display	Displayed when the silent mode control is active.
⑫	Motion sensor display	Displayed when the infrared sensor control (motion sensor control) is enabled.
⑬	Anti draft setting display	Displayed when anti draft setting is enabled.
⑭	Child lock display	Displayed when child lock is enabled.

Operation section

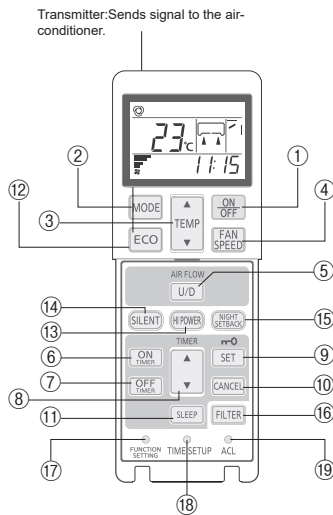

①	ON/OFF button	When this is pressed once, the air-conditioner starts to operate and when this is pressed once again, it stops operating.
②	MODE button	Every time this button is pressed, displays switch as below [ (AUTO) → (COOL) → (HEAT) ] [ (FAN) ← (DRY) ← ]
③	TEMP button	Change the set temperature by pressing ▲ or ▼ button.
④	FAN SPEED button	The fan speed is switched in the following order: 1-speed → 2-speed → 3-speed → 4-speed → AUTO → 1-speed.
⑤	U/D button	Used to determine the up/down louver position.
⑥	ON TIMER button	Used to set the ON TIMER.
⑦	OFF TIMER button	Used to set the OFF TIMER.
⑧	SELECT button	Used to switch the time when setting the timer or adjusting the time. Used to switch the settings of the indoor function.
⑨	SET button	Used to determine the setting when setting the timer or adjusting the time. Used to determine the settings of the indoor function. When press and hold SET button, Child Lock is enabled.
⑩	CANCEL button	Used to cancel the timer setting.
⑪	SLEEP button	Used to set the sleep timer.
⑫	ECO button	Pressing this button starts the energy-saving operation. Pressing this button again cancels it.
⑬	HI POWER button	Pressing this button starts the high power operation. Pressing this button again cancels it.
⑭	SILENT button	Pressing this button starts the silent mode control. Pressing this button again cancels it.
⑮	NIGHT SETBACK button	Pressing this button starts the home leave mode. Pressing this button again cancels it.
⑯	FILTER button	Pressing this button resets FILTER SIGN.
⑰	FUNCTION SETTING switch	Used to set the indoor function.
⑱	TIME SETUP switch	Used to set the current time.
⑲	ACL switch	Used to reset the microcomputer.

(b) SRK series only

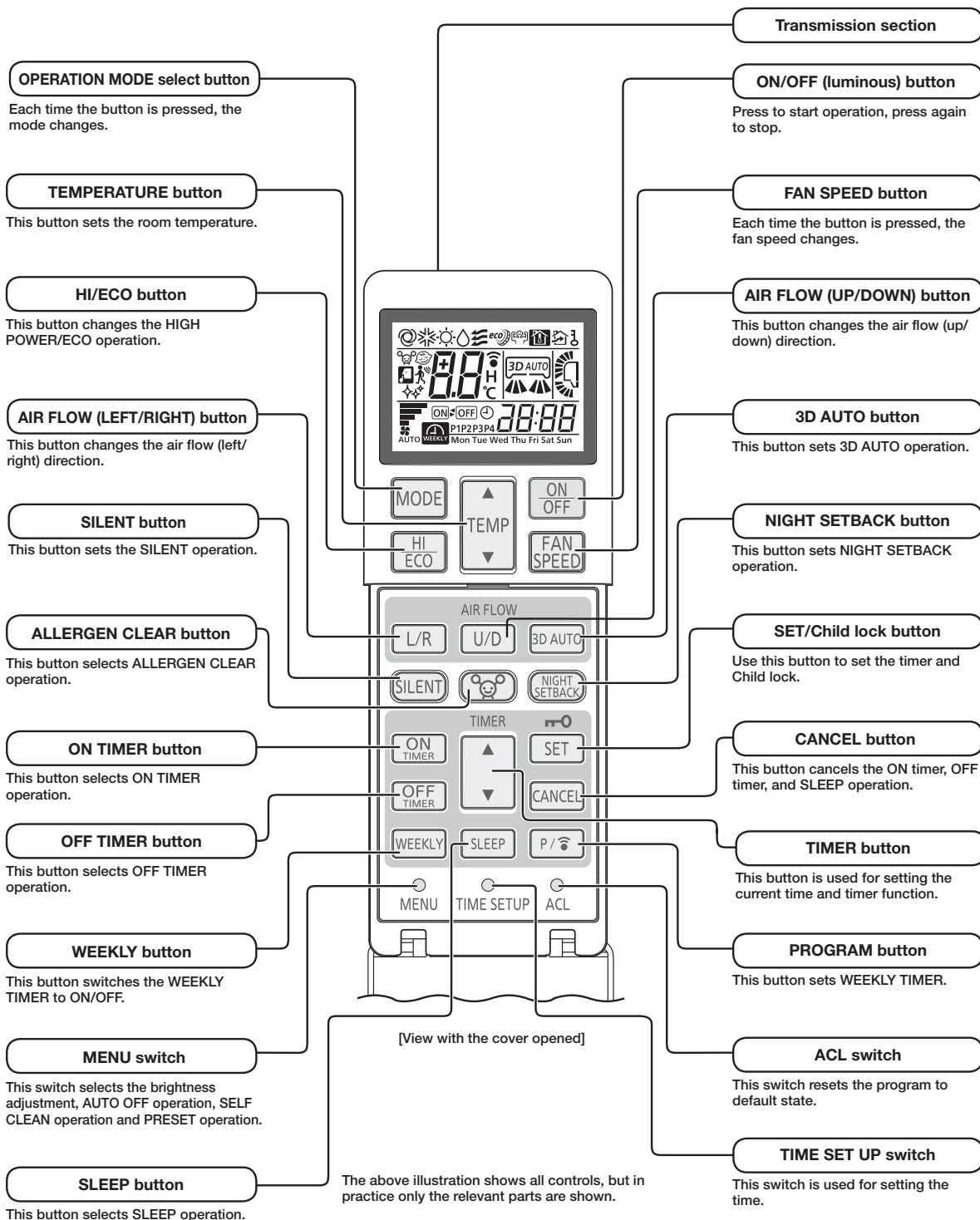

## 1.2 Operation control function by the wired remote control

### ● Model RC-EX3A

#### (1) Switching sequence of the operation mode switches of remote control

- Tap the change operation mode button on the TOP screen.
- When the change operation mode screen is displayed, tap the button of desired mode.
- When the operation mode is selected, the display returns to the TOP screen.

Icons displayed have the following meanings.

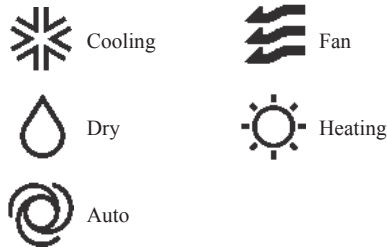

Notes(1) Operation modes which cannot be selected depending on combinations of indoor unit and outdoor unit are not displayed.

(2) When the Auto is selected, the cooling and heating switching operation is performed automatically according to indoor and outdoor temperatures.

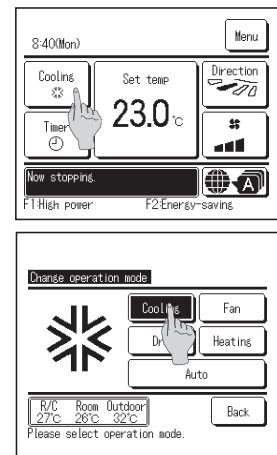

#### (2) CPU reset

Reset CPU from the remote control as follows.

TOP screen  ⇒  ⇒  ⇒

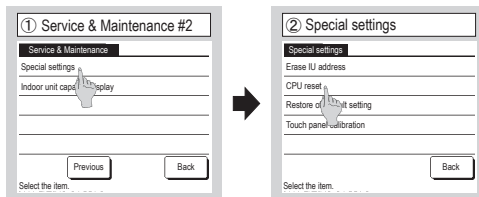

The selected screen is displayed.

The selected screen is displayed.

#### 

Microcomputers of indoor unit and outdoor unit connected are reset (State of restoration after power failure).

#### (3) Power failure compensation function (Electric power source failure)

Enable the Auto-restart function from the remote control as follows.

TOP screen  ⇒  ⇒  ⇒

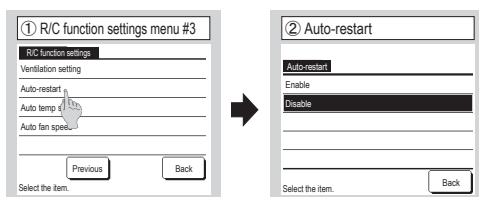

If the unit stops during operation,

#### 

It returns to the state before the power failure as soon as the power source is restored (After the end of the primary control at the power on).

#### 

It stops after the restoration of power source.

● Since the status of remote control is retained in memory always, it restarts operations according to the contents of memory as soon as the power source is restored. Although the timer mode is cancelled, the weekly timer, peak cut timer and silent mode timer operate according to the following contents:

- When the clock setting is valid : These timer settings are also valid.
- When the clock setting is invalid : These timer settings become “Invalid” since the clock setting is invalid. These timer settings have to be changed to “Valid” after the timer setting.



- Content memorized with the power failure compensation are as follows.

Note(1) Items (f) and (g) are memorized regardless whether the power failure compensation is effective or not while the setting of silent mode is cancelled regardless whether the power failure compensation is effective or not.

- (a) At power failure – Operating/stopped  
If it had been operating under the off timer mode, sleep timer mode, the state of stop is memorized.
- (b) Operation mode
- (c) Air flow volume mode
- (d) Room temperature setting
- (e) Louver auto swing/stop  
However, the stop position (4-position) is cancelled so that it returns to Position (1).
- (f) “Remote control function items” which have been set with the administrator or installation function settings (“Indoor function items” are saved in the memory of indoor unit.)
- (g) Weekly timer, peak-cut timer or silent mode timer settings
- (h) Remote control function setting

#### (4) Alert displays

If the following (a) to (c) appear, check and repair as follows.

##### (a) Communication check between indoor unit and remote control

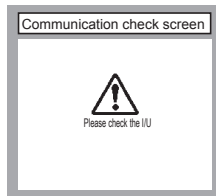

- This appears if communications cannot be established between the remote control and the indoor unit.  
Check whether the system is correctly connected (indoor unit, outdoor unit, remote control) and whether the power source for the outdoor unit is connected.

##### (b) Clock setting check

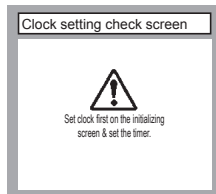

- This appears when the timer settings are done without clock setting.  
Set the clock setting before the timer settings.

##### (c) Misconnection

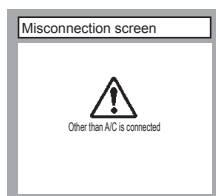

- This appears when something other than the air-conditioner has been connected to the remote control.  
Check the location to which the remote control is connected.

● Model RC-E5

(1) Switching sequence of the operation mode switches of remote control

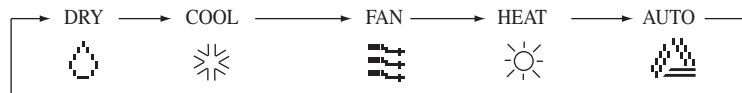

(2) CPU reset

This functions when “CHECK” and “ESP” buttons on the remote control are pressed simultaneously. Operation is same as that of the power source reset.

(3) Power failure compensation function (Electric power source failure)

- This becomes effective if “Power failure compensation effective” is selected with the setting of remote control function.
- Since it memorizes always the condition of remote control, it starts operation according to the contents of memory no sooner than normal state is recovered after the power failure. Although the auto swing stop position and the timer mode are cancelled, the weekly timer setting is restored with the holiday setting for all weekdays. After recovering from the power failure, it readjusts the clock and resets the holiday setting for each weekday so that the setting of weekly timer becomes effective.
- Content memorized with the power failure compensation are as follows.

Note (1) Items (f), (g) and (h) are memorized regardless whether the power failure compensation is effective or not while the setting of silent mode is cancelled regardless whether the power failure compensation is effective or not.

- (a) At power failure – Operating/stopped  
If it had been operating under the off timer mode, sleep timer mode, the state of stop is memorized. (Although the timer mode is cancelled at the recovery from power failure, the setting of weekly timer is changed to the holiday setting for all weekdays.)
- (b) Operation mode
- (c) Air flow volume mode
- (d) Room temperature setting
- (e) Louver auto swing/stop  
However, the stop position (4-position) is cancelled so that it returns to Position (1).
- (f) “Remote control function items” which have been set with the remote control function setting (“Indoor function items” are saved in the memory of indoor unit.)
- (g) Upper limit value and lower limit value which have been set with the temperature setting control
- (h) Sleep timer and weekly timer settings (Other timer settings are not memorized.)

[Parts layout on remote control PCB]

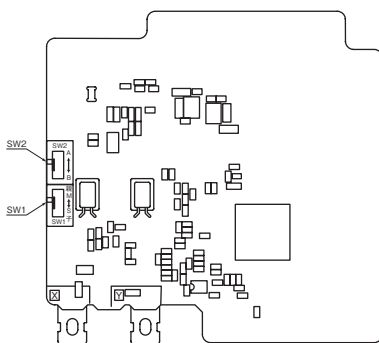

**Master/ slave setting when more than one remote controls are used**

A maximum of two remote controls can be connected to one indoor unit (or one group of indoor units.)

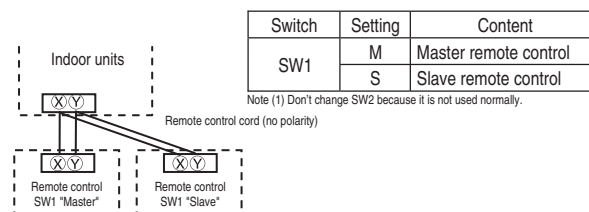

Switch	Setting	Content
SW1	M	Master remote control
	S	Slave remote control

Note (1) Don't change SW2 because it is not used normally.

**Caution**

When using multiple remote controls, the following displays or settings cannot be done with the slave remote control. It is available only with the master remote control.

- ① Louver position setting (set upper or lower limit of swinging range)
- ② Setting indoor unit functions
- ③ Setting temperature range
- ④ Operation data display
- ⑤ Error data display
- ⑥ Silent mode setting
- ⑦ Test operation of drain pump
- ⑧ Remote control sensor setting

### 1.3 Operation control function by the indoor control

#### ( I ) FDT, FDU, FDUM, FDE series

##### (1) Auto operation

- (a) If "Auto" mode is selected by the remote control, the heating and the cooling are automatically switched according to the difference between outdoor air temperature and setting temperature and the difference between setting temperature and return air temperature. (When the switching of cooling mode ↔ heating mode takes place within 3 minutes, the compressor does not operate for 3 minutes by the control of 3-minute timer.) This will facilitate the cooling/heating switching operation in intermediate seasons and the adaptation to unmanned operation at stores, etc (ATM corner of bank).

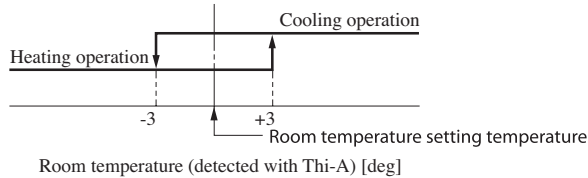

Notes (1) Temperature range of switching cooling/heating mode can be changed by RC-EX3A from ±1.0 – ±4.0.

- (2) Room temperature control during auto cooling/auto heating is performed according to the room temperature setting temperature. (DIFF: ±1 deg)  
 (3) If the indoor heat exchanger temperature rises to 59°C or higher during heating operation, it is switched automatically to cooling operation. In addition, for 1 hour after this switching, the heating operation is not performed, regardless of the temperature shown at right.

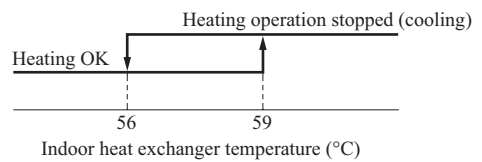

- (b) The following automatic controls are performed other than (a) above.

- (i) Cooling or heating operation mode is judged according to the conditions of the "Judgment based on Setting temperature + Cooling select temperature and Indoor return air temperature" and the "Judgment based on Outdoor temperature".

- 1) In "Setting temperature - Cooling select temperature < Indoor return air temperature" and "Outdoor temperature/Cooling < Outdoor return air temperature" ⇒ Operation mode: Cooling
- 2) "Setting temperature + Heating select temperature > Indoor return air temperature" and "Outdoor temperature/Heating > Outdoor air temperature" ⇒ Operation mode: Heating
- 3) The outdoor air temperature of the above judgment conditions is sampled at every 10 minutes.
- 4) In the range where the above cooling and heating zones are overlapped ⇒ Forced thermostat OFF

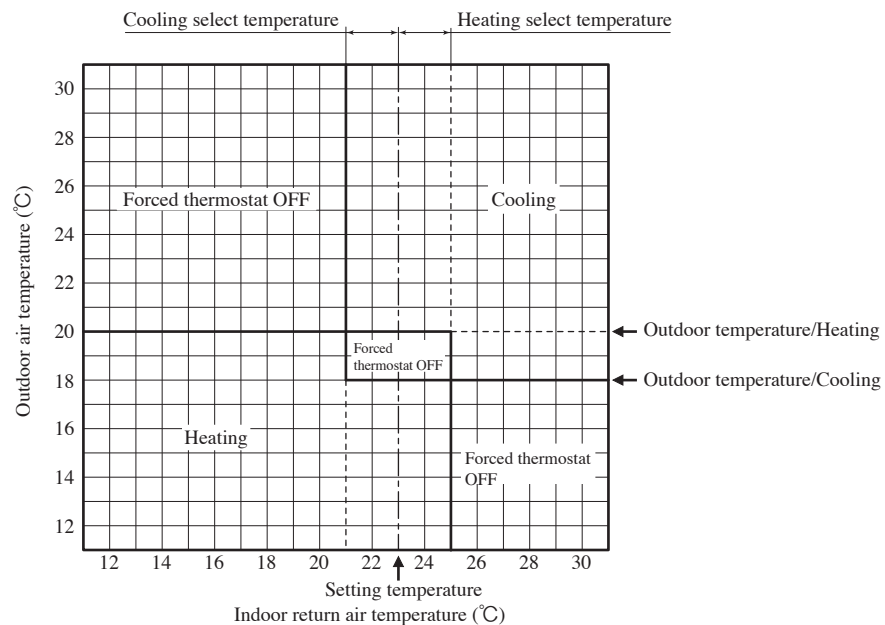

- (ii) Regardless of the setting temperature, the cooling or heating operation mode is judged according to the "Judgment based on Room temperature/Cooling or Heating and Outdoor temperature/Cooling or Heating".
  - 1) In case of "Room temperature/Cooling < Indoor return air temperature" and "Outdoor temperature/Cooling < Outdoor air temperature" ⇒ Operation mode: Cooling
  - 2) In case of "Room temperature/Heating > Indoor return air temperature" and "Outdoor temperature /Heating > Outdoor air temperature" ⇒ Operation mode: Heating
  - 3) The outdoor air temperature of the above judgment conditions is sampled at every 10 minutes.
  - 4) In the range where the above cooling and heating zones are overlapped ⇒ Forced thermostat OFF

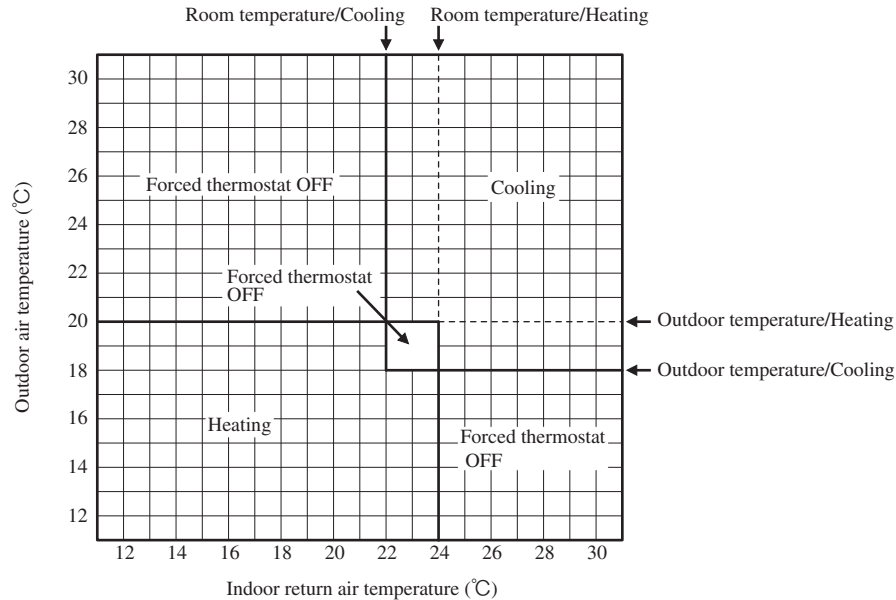

**(2) Operations of functional items during cooling/heating**

Operation / Functional item	Cooling		Fan	Heating			Dehumidifying
	Thermostat ON	Thermostat OFF		Thermostat ON	Thermostat OFF	Hot start (Defrost)	
Compressor	○	×	×	○	×	○	○/×
4-way valve	×	×	×	○	○	○(×)	×
Outdoor fan	○	×	×	○	×	○(×)	○/×
Indoor fan	○	○	○	○/×	○/×	○/×	○/×
Drain pump <sup>(3)</sup>	○	× <sup>(2)</sup>	× <sup>(2)</sup>	○/× <sup>(2)</sup>			Thermostat ON: ○ Thermostat OFF: × <sup>(2)</sup>

Notes (1) ○: Operation ×: Stop ○/×: Turned ON/OFF by the control other than the room temperature control.  
 (2) ON during the drain pump motor delay control.  
 (3) Drain pump ON setting may be selected with the indoor unit function setting of the wired remote control.

**(3) Dehumidifying (DRY) operation**

**(a) FDT series**

Indoor ambient temperatures and humidity are controlled simultaneously with the relative humidity sensor (HS) and the suction temperature sensor [Thi-A (or the remote control sensor when it is activated)], which are installed at the suction inlet.

- (i) When the operation has been started with cooling, if there is a difference of 2°C or less between the suction and setting temperatures, the tap of indoor fan is lowered by one tap. This tap is retained for 3 minutes after changing the tap.
- (ii) After the above condition, when a difference between suction and setting temperature is lower than 3°C, and the relative humidity is high, the tap of indoor unit fan is lowered by one tap.  
 When the difference between suction and setting temperature is larger than 3°C, the fan of indoor unit fan is raised by one tap. This tap is retained for 3 minutes after changing the tap.
- (iii) When relative humidity becomes lower, the indoor unit fan tap is retained.
- (iv) In case of the thermostat OFF, the indoor unit fan tap at the thermostat ON is retained.

**(b) FDU, FDUM, FDE series**

Return air temperature sensor [Thi-A (by the remote control when the remote control sensor is enabled)] controls the indoor temperature environment simultaneously.

- (i) Operation is started in the cooling mode. When the difference between the return air temperature and the setting temperature is 2°C or less, the indoor unit fan tap is brought down by one tap. That tap is retained for 3 minutes after changing the indoor unit fan tap.
- (ii) If the return air temperature exceeds the setting temperature by 3°C during dehumidifying operation, the indoor unit fan tap is raised. That tap is retained for 3 minutes after changing the indoor unit fan tap.
- (iii) If the thermostat OFF is established during the above control, the indoor unit fan tap at the thermostat ON is retained so far as the thermostat is turned OFF.

**(4) Timer operation**

**(a) RC-EX3A**

- (i) Sleep timer  
Set the time from the start to stop of operation. The time can be selected in the range from 30 to 240 minutes (in the unit of 10-minute).  
Note (1) Enable the “Sleep timer” setting from the remote control. If the setting is enabled, the timer operates at every time.
- (ii) Set OFF timer by hour  
Set the time to stop the unit after operation, in the range from 1 to 12 hours (in the unit of hour).
- (iii) Set ON timer by hour  
Set the time to start the unit after the stop of operation, in the range from 1 to 12 hours (in the unit of hour). It is allowed also to set simultaneously the indoor temperature, operation mode, air flow rate and warm-up enabled/disabled.
- (iv) Set ON timer by clock  
Set the time to start operation. The time can be set in the unit of 5-minute. This setting can be activated only once or at every time. It is allowed also to set simultaneously the indoor temperature, operation mode, air flow rate and warm-up enabled/disabled.  
Note (1) It is necessary to set the clock to use this timer.
- (v) Set OFF timer by clock  
Set the time to stop operation. The time can be set in the unit of 5-minute. This setting can be activated only once or at every time.  
Note (1) It is necessary to set the clock to use this timer.
- (vi) Weekly timer  
Set the ON or OFF timer for a week. Up to 8 patterns can be set for a day. The day-off setting is provided for holidays and non-business days.  
Note (1) It is necessary to set the clock to use the weekly timer.

**(vii) Combination of patterns which can be set for the timer operations**

	Sleep time	Set OFF timer by hour	Set ON timer by hour	Set OFF timer by clock	Set ON timer by clock	Weekly timer
Sleep time		×	×	○	○	○
Set OFF timer by hour	×		×	×	×	×
Set ON timer by hour	×	×		×	×	×
Set OFF timer by clock	○	×	×		○	×
Set ON timer by clock	○	×	×	○		×
Weekly timer	○	×	×	×	×	

Note (1) ○: Allowed ×: Not

**(b) RC-E5**

- (i) Sleep timer  
Set the duration of time from the present to the time to turn off the air-conditioner.  
It can be selected from 10 steps in the range from “OFF 1 hour later” to “OFF 10 hours later”. After the sleep timer setting, the remaining time is displayed with progress of time in the unit of hour.
- (ii) OFF timer  
Time to turn OFF the air-conditioner can be set in the unit of 10 minutes.
- (iii) ON timer  
Time to turn ON the air-conditioner can be set. Indoor temperature can be set simultaneously.
- (iv) Weekly timer  
Timer operation (ON timer, OFF timer) can be set up to 4 times a day for each weekday.

## (v) Timer operations which can be set in combination

Item \ Item	Timer	OFF timer	ON timer	Weekly timer
Timer		×	○	×
OFF timer	×		○	×
ON timer	○	○		×
Weekly timer	×	×	×	

Notes (1) ○: Allowed ×: Not

(2) Since the ON timer, sleep timer and OFF timer are set in parallel, when the times to turn ON and OFF the air-conditioner are duplicated, the setting of the OFF timer has priority.

**(5) Hot start (Cold draft prevention at heating)****(a) Operating conditions**

When either one of following conditions is satisfied, the hot start control is performed.

- (i) From stop to heating operation
- (ii) From cooling to heating operation
- (iii) Form heating thermostat OFF to ON
- (iv) After completing the defrost operation (only on units with thermostat ON)

**(b) Contents of operation**

## (i) Indoor fan motor control at hot start

- 1) Within 7 minutes after starting heating operation, the fan mode is determined depending on the condition of thermostat (fan control with heating thermostat OFF).

## a) Thermostat OFF

- i) Operates according to the fan control setting at heating thermostat OFF.
- ii) Even if it changes from thermostat OFF to ON, the fan continues to operate with the fan control at thermostat OFF till the heat exchanger temperature sensor (Thi-R1 or R2, whichever higher) detects 35°C or higher.
- iii) When the heat exchanger temperature sensor (Thi-R1 or R2, whichever higher) detects 35°C or higher, the fan operates with the set air flow volume.

## b) Thermostat ON

- i) When the heat exchanger temperature sensor (Thi-R1 or R2, whichever higher) detects 25°C or lower, the fan is turned OFF and does not operate.
  - ii) When the heat exchanger temperature sensor (Thi-R1 or R2, whichever higher) detects 25°C or higher, the fan operates with the fan control at heating thermostat OFF.
  - iii) When the heat exchanger temperature sensor (Thi-R1 or R2, whichever higher) detects 35°C or higher, the fan operates with the set air flow volume.
- c) If the fan control at heating thermostat OFF is set at the "Set air flow volume" (from the remote control), the fan operates with the set air flow volume regardless of the thermostat ON/OFF.

- 2) Once the fan motor is changed from OFF to ON during the thermostat ON, the indoor fan motor is not turned OFF even if the heat exchanger temperature sensor detects lower than 25°C.

Note (1) When the defrost control signal is received, it complies with the fan control during defrost operation.

- 3) Once the hot start is completed, it will not restart even if the temperature on the heat exchanger temperature sensor drops.

(ii) During the hot start, the louver is kept at the horizontal position.

(iii) When the fan motor is turned OFF for 7 minutes continuously after defrost operation, the fan motor is turned ON regardless of the temperatures detected with the indoor heat exchanger temperature sensors (Thi-R1, R2).

**(c) Ending condition**

(i) If one of following conditions is satisfied during the hot start control, this control is terminated, and the fan is operated with the set air flow volume.

- 1) Heat exchanger temperature sensor (Thi-R1 or R2, whichever higher) detects 35°C or higher.
- 2) It has elapsed 7 minutes after starting the hot start control.

**(6) Hot keep**

Hot keep control is performed at the start of the defrost operation.

**(a) Control**

- (i) When the indoor heat exchanger temperature (detected with Thi-R1 or R2) drops to less than 35°C, the speed of indoor fan follows fan setting at the time of thermostat OFF.
- (ii) During the hot keep, the louver is kept at the horizontal position.

**(7) Auto swing control (FDT, FDE only)**

**Note** Even if [Auto Swing] is selected, the louver position with anti draft function is fixed to position 1.

**(a) RC-EX3A****(i) Louver control**

- 1) To operate the swing louver when the air-conditioner is operating, press the “Direction” button on the TOP screen of remote control. The wind direction select screen will be displayed.
- 2) To swing the louver, touch the “Auto swing” button. The lover will move up and down. To fix the swing louver at a position, touch one of [1] - [4] buttons. The swing lover will stop at the selected position.
- 3) Louver operation at the power on with a unit having the louver 4-position control function  
The louver swings one time automatically (without operating the remote control) at the power on.  
This allows the microcomputer recognizing and inputting the louver motor (LM) position.



**(ii) Automatic louver level setting during heating**

At the hot start and the heating thermostat OFF, regardless whether the auto swing switch is operated or not (auto swing or louver stop), the louver takes the level position (in order to prevent blowing of cool wind). The louver position display LCD continues to show the display which has been shown before entering this control.

**(iii) Louver free stop control**

If you touch the “Menu” → “Next” → “R/C settings” buttons one after another on the TOP screen of remote control, the “Flap control” screen is displayed. If the free stop is selected on this screen, the louver motor stops upon receipt of the stop signal from the remote control. If the auto swing signal is received from the remote control, the auto swing will start from the position before the stop.

**(b) RC-E5****(i) Louver control**

- 1) Press the “LOUVER” button to operate the swing louver when the air-conditioner is operating.  
“SWING ” is displayed for 3 seconds and then the swing louver moves up and down continuously.
- 2) To fix the swing louver at a position, press one time the “LOUVER” button while the swing louver is moving so that four stop positions are displayed one after another per second.  
When a desired stop position is displayed, press the “LOUVER” button again. The display stops, changes to show the “STOP 1 ” for 5 seconds and then the swing louver stops.
- 3) Louver operation at the power on with a unit having the louver 4-position control function  
The louver swings one time automatically (without operating the remote control) at the power on.  
This allows inputting the louver motor (LM) position, which is necessary for the microcomputer to recognize the louver position.

Note (1) If you press the “LOUVER” button, the swing motion is displayed on the louver position LCD for 10 seconds. The display changes to the “SWING ” display 3 seconds later.

**(ii) Automatic louver level setting during heating**

At the hot start with the heating thermostat OFF, regardless whether the auto swing switch is operated or not (auto swing or louver stop), the louver takes the level position (In order to prevent the cold start). The louver position display LCD continues to show the display which has been shown before entering this control.

**(iii) Louver-free stop control**

When the louver-free stop has been selected with the indoor function of wired remote control “ POSITION”, the louver motor stops when it receives the stop signal from the remote control. If the auto swing signal is received from the remote control, the auto swing will start from the position where it was before the stop.

Note (1) When the indoor function of wired remote control “ POSITION” has been switched, switch also the remote control function “ POSITION” in the same way.

**(8) Thermostat operation**

**(a) Cooling**

- (i) Thermostat is operated with the room temperature control.
- (ii) Thermostat is turned ON or OFF relative to the set room temperature as shown below.

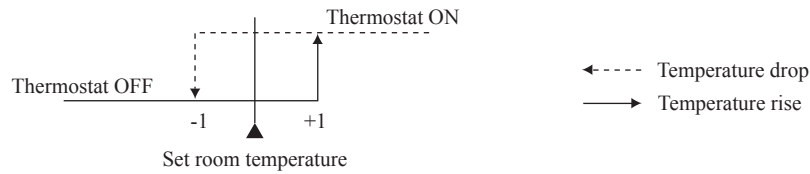

- (iii) Thermostat is turned ON when the room temperature is in the range of  $-1 < \text{Set temperature} < +1$  at the start of cooling operation (including from heating to cooling).

**(b) Heating**

- (i) Thermostat is operated with the room temperature control.
- (ii) Thermostat is turned ON or OFF relative to the set room temperature as shown below.

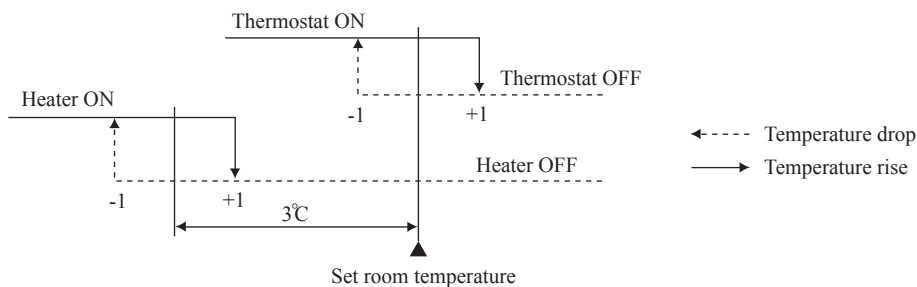

- (iii) Thermostat is turned ON when the room temperature is in the range of  $-1 < \text{Set point} < +1$  at the start of heating operation (Including from cooling to heating).

**(c) Fan control during heating thermostat OFF**

- (i) Following fan controls during the heating thermostat OFF can be selected with the indoor function setting of the wired remote control.
  - ① Low fan speed (Factory default), ② Set fan speed, ③ Intermittence, ④ Fan OFF
- (ii) When the “Low fan speed (Factory default)” is selected, the following taps are used for the indoor fans.
  - For DC motor : ULo tap
- (iii) When the “Set fan speed” is selected, it is operated with the set fan speed also in the thermostat OFF condition.
- (iv) If the “Intermittence” is selected, following controls are performed:
  - 1) If the thermostat is turned OFF during the heating operation, the indoor unit moves to the hot control and turns OFF the indoor fan if the heat exchanger temperature sensors (both Thi-R1 and R2) detect 25°C or lower.
  - 2) Indoor fan OFF is fixed for 5 minutes. After the 5 minutes, the indoor fan is operated at ULo for 2 minutes. In the meantime the louver is controlled at level.
  - 3) After operating at ULo for 2 minutes, the indoor fan moves to the state of 1) above.
  - 4) If the thermostat is turned ON, it moves to the hot start control.
  - 5) When the heating thermostat is turned OFF, the remote control displays the temperature detected at the fan stop and revises the temperature later when the indoor fan changes from ULo to stop. The remote control uses the operation data display function to display temperatures and updates values of temperature even when the indoor fan is turned OFF.
  - 6) When the defrost operation starts while the heating thermostat is turned OFF or the thermostat is turned OFF during defrost operation, the indoor fan is turned OFF. (Hot keep or hot start control takes priority.) However, the suction temperature is updated at every 7-minute.
  - 7) When the heating thermostat is turned ON or the operation is changed to another mode (including stop), this control is stopped immediately, and the operating condition is restored.
- (v) When the “Fan OFF” is selected, the fan on the indoor unit of which the thermostat has been turned OFF, is turned OFF. The same occurs also when the remote control sensor is effective.



**(d) Fan control during cooling thermostat OFF**

- (i) Following fan controls during the cooling thermostat OFF can be selected with the indoor function setting of the wired remote control.
  - ① Low fan speed, ② Set fan speed (Factory default), ③ Intermittence, ④ Fan OFF
- (ii) When the “Low fan speed” is selected, the following taps are used for the indoor fans.
  - For DC motor : ULo tap
- (iii) When the “Set fan speed” is selected, it is operated with the set fan speed also in the thermostat OFF condition.
- (iv) If the “Intermittence” is selected, following controls are performed:
  - 1) If the thermostat is turned OFF during the cooling operation, the indoor unit fan motor stope.
  - 2) Indoor fan OFF is fixed for 5 minutes. After the 5 minutes, the indoor fan is operated at ULo for 2 minutes. In the meantime the louver is controlled at level.
  - 3) After operating at ULo for 2 minutes, the indoor fan moves to the state of 1) above.
  - 4) If the thermostat is turned ON, the fan starts operation at set fan speed.
  - 5) When the cooling thermostat is turned OFF, the remote control displays the temperature detected at the fan stop and revises the temperature later when the indoor fan changes from ULo to stop.  
By using operation data display function at wireless remote control, the temperature as displayad and the value is updated including the fan stops.
  - 6) When the cooling thermostat is turned ON or the operation is changed to another mode (Including stop), this control is stopped immediately, and the operating condition is restored.
- (v) When the “Fan OFF” is selected, the fan on the indoor unit of which the thermostat has been turned OFF, is turned OFF. The same occurs also when the remote control sensor is effective.

**(9) Filter sign**

As the operation time (Total ON time of ON/OFF switch) accumulates to 180 hours (1), “FILTER CLEANING” is displayed on the remote control. (This is displayed when the unit is in trouble and under the central control, regardless of ON/OFF.)

Notes (1) Time setting for the filter sign can be made as shown below using the indoor function of wired remote control “Filter sign”. (It is set at setting 1 at the shipping from factory.)

Filter sign setting	Function
Setting 1	Setting time: 180 hrs (Factory default)
Setting 2	Setting time: 600 hrs
Setting 3	Setting time: 1,000 hrs
Setting 4	Setting time: 1,000 hrs (Unit stop) <sup>(2)</sup>

(2) After the setting time has elapsed, the “FILTER CLEANING” is displayed and, after operating for 24 hours further (counted also during the stop), the unit stops.

**(10) Compressor inching prevention control**

**(a) 3-minute timer**

When the compressor has been stopped by the thermostat, remote control operation switch or anomalous condition, its restart will be inhibited for 3 minutes. However, the 3-minute timer is invalidated at the power on the electric power source for the unit.

**(b) 3-minute forced operation timer**

- (i) Compressor will not stop for 3 minutes after the compressor ON. However, it stops immediately when the unit is stopped by means of the ON/OFF switch or by when the thermostat turned OFF the change of operation mode.
- (ii) If the thermostat is turned OFF during the forced operation control of heating compressor, the louver position (with the auto swing) is returned to the level position.

Note (1) The compressor stops when it has entered the protective control.

**(11) Drain pump control**

- (a) This control is operated when the inverter frequency is other than 0 Hz during the cooling operation and automatic cooling and dehumidifying operations.
- (b) Drain pump ON condition continues for 5 minutes even when it enters the OFF range according to (i) above after turning the drain pump ON, and then stops. The 5-minute delay continues also in the event of anomalous stop.
- (c) The drain pump is operated with the 5-minute delay operation when the compressor is changed from ON to OFF.
- (d) Even in conditions other than the above (such as heating, fan, stop, cooling thermostat OFF), the drain pump control is performed by the drain detection.
- (e) Following settings can be made using the indoor function setting of the wired remote control.
  - (i) 标准 [Standard (in cooling & dry)] : Drain pump is run during cooling and dry.
  - (ii) 标准AND采暖 [Operate in standard & heating] : Drain pump is run during cooling, dry and heating.
  - (iii) 标准AND采暖AND送风 [Operate in heating & fan] : Drain pump is run during cooling, dry, heating and fan.
  - (iv) 标准AND送风 [Operate in standard & fan] : Drain pump is run during cooling, dry and fan.

Note (1) Values in [ ] are for the RC-EX3A model.

**(12) Drain pump motor (DM) control**

- (a) Drain detection switch is turned ON or OFF with the float switch (FS) and the timer.

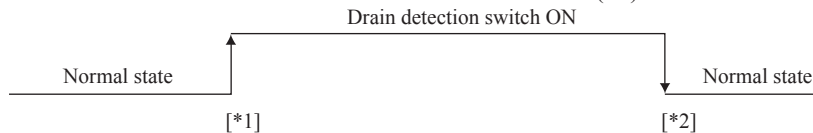

[\*1] Drain detection switch is turned “ON” when the float switch “Open” is detected for 3 seconds continuously in the drain detectable space.

[\*2] Drain detection switch is turned “OFF” when the float switch “Close” is detected for 10 seconds continuously.

- (i) It detects always from 30 seconds after turning the power ON.
  - 1) There is no detection of anomalous draining for 10 seconds after turning the drain pump OFF.
  - 2) Turning the drain detection switch “ON” causes to turn ON the drain pump forcibly.
  - 3) Turning the drain detection switch “OFF” releases the forced drain pump ON condition.
- (b) Indoor unit performs the control A or B depending on each operating condition.

	Indoor unit operation mode				
	Stop <sup>(1)</sup>	Cooling	Dry	Fan <sup>(2)</sup>	Heating
Compressor ON		Control A			
Compressor OFF		Control B			

Notes (1) Including the stop from the cooling, dehumidifying, fan and heating, and the anomalous stop  
 (2) Including the “Fan” operation according to the mismatch of operation modes

- (i) Control A
  - 1) If the float switch detects any anomalous draining condition, the unit stops with the anomalous stop (displays E9) and the drain pump starts. After detecting the anomalous condition, the drain pump motor continues to be ON.
  - 2) It keeps operating while the float switch is detecting the anomalous condition.
- (ii) Control B
 

If the float switch detects any anomalous drain condition, the drain pump motor is turned ON for 5 minutes, and at 10 seconds after the drain pump motor OFF it checks the float switch. If it is normal, the unit is stopped under the normal mode or, if there is any anomalous condition, E9 is displayed and the drain pump motor is turned ON. (The ON condition is maintained during the drain detection.)

**(13) Operation check/drain pump test run operation mode**

- (a) If the power is turned on by the DIP switch (SW7-1) on the indoor unit control PCB when electric power source is supplied, it enters the mode of operation check/drain pump test run. It is ineffective (prohibited) to change the switch after turning power on.
- (b) When the communication with the remote control has been established within 60 seconds after turning power on by the DIP switch (SW7-1) ON, it enters the operation check mode. Unless the remote control communication is established, it enters the drain pump test run mode.

Note (1) To select the drain pump test run mode, disconnect the remote control connector (CNB) on the indoor PCB to shut down the remote control communication.

(c) Operation check mode

There is no communication with the outdoor unit but it allows performing operation in respective modes by operating the remote control.

(d) Drain pump test run mode

As the drain pump test run is established, the drain pump only operates and during the operation protective functions by the microcomputer of indoor unit become ineffective.

**(14) Cooling, dehumidifying frost protection**

(a) To prevent frosting during cooling mode or dehumidifying mode operation, the thermostat-OFF if the indoor heat exchanger temperature (detected with Thi-R) drops to 1.0 °C or lower at 4 minutes after the thermostat-ON. If the indoor unit heat exchanger temperature is 1.0 °C or lower after 5 minutes, the indoor unit is controlled thermostat-OFF. If it becomes 10°C or higher, the control terminates. When the indoor heat exchanger temperature has become as show, the indoor unit send outdoor unit the “Anti-frost” signal.

- Frost prevention temperature setting can be selected with the indoor unit function setting of the wired remote control.

Item	Symbol	A
Temperature - Low (Factory default)		1.0
Temperature - High		2.5

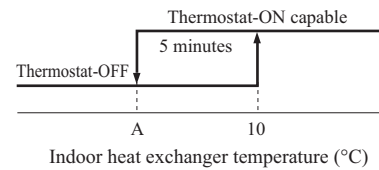

(b) Selection of indoor fan speed

If it enters the frost prevention control during cooling operation (excluding dehumidifying), the indoor fan speed is switched.

- When the indoor return air detection temperature (detected with Thi-A) is C°C or higher and the indoor heat exchanger temperature (detected with Thi-R) detects the compressor frequency drop start temperature A°C+1°C, indoor fan speed is increased by 20min<sup>-1</sup>.
- If the phenomenon of (i) above is detected again after the acceleration of indoor fan, indoor fan speed is increased further by 20min<sup>-1</sup>.

Note (1) Indoor fan speed can be increased by up to 2 taps.

- Compressor frequency drop start temperature (FDT only)

Hs > 50%

Symbol	Item	Low	High
A		1.0	2.5
B		2.5	4.0

Hs ≤ 50%

Symbol	Item	Low	High
A		-0.5	1.0
B		1.0	2.5

- Indoor fan speed control start temperature

Symbol	Indoor	FDT-VH	Other
C		18	23

Note (1) Frost prevention temperature setting can be selected with the indoor unit function setting of the wired remote control.

**(15) Heating overload protection**

(a) If the indoor heat exchanger temperature (detected with Thi-R) at 63°C or higher is detected for 2 seconds continuously, the compressor stops. When the compressor is restarted after a 3-minute delay, if a temperature at 63°C or higher is detected for 2 seconds continuously within 60 minutes after initial detection and if this is detected 5 times consecutively, the compressor stops with the anomalous stop (E8). Anomalous stop occurs also when the indoor heat exchanger temperature at 63°C or higher is detected for 6 minutes continuously.

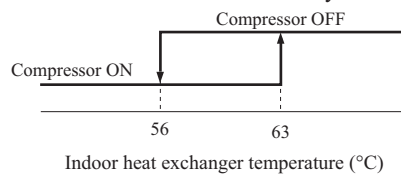

(b) Indoor unit fan speed selection

If, after second detection of heating overload protection up to fourth, the indoor fan is set at below Hi tap when the compressor is turned ON, the indoor fan speed is increased by 1 tap.

**(16) Anomalous fan motor**

- After starting the fan motor, if the fan motor speed is 200 min<sup>-1</sup> or less is detected for 30 seconds continuously and 4 times within 60 minutes, then fan motor stops with the anomalous stop (E16).
- If the fan motor fails to reach at -50 min<sup>-1</sup>(FDU:-500 min<sup>-1</sup>) less than the required speed, it stops with the anomalous stop (E20).

**(17) Plural unit control – Control of 16 units group by one remote control**

**(a) Function**

One remote control can control a group of multiple number of unit (Max. 16 indoor units). “Operation mode” which is set by the remote control can operate or stop all units in the group one after another in the order of unit. No.<sup>(1)</sup>. Thermostat and protective function of each unit function independently.

Note (1) Unit No. is set by SW2 on the indoor unit control PCB. Unit No. setting by SW2 is necessary for the indoor unit only.

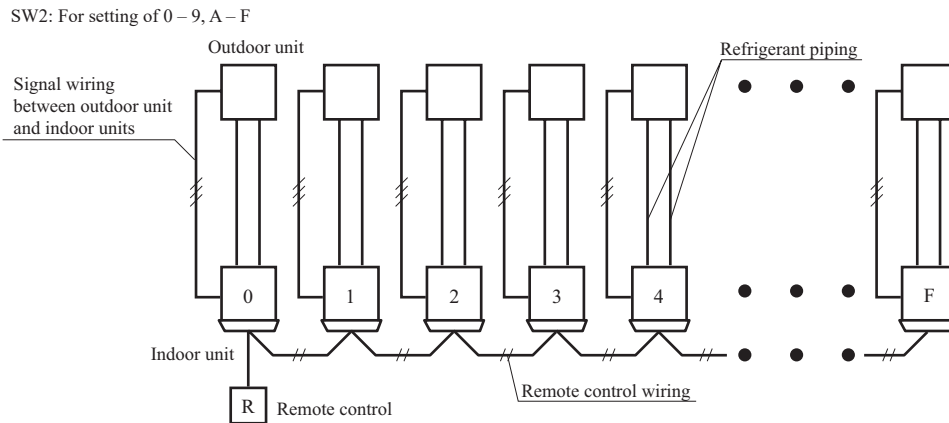

(2) Unit No. may be set at random unless duplicated, it should be better to set orderly like 0, 1, 2..., F to avoid mistake.

**(b) Display to the remote control**

- (i) Central or each remote control basis, heating preparation  
The smallest unit No. among the operating units in the remote mode (or the center mode unless the remote mode is available) is displayed.
- (ii) Inspection display, filter sign  
Any of unit that starts initially is displayed.

**(c) Confirmation of connected units**

- (i) In case of RC-EX3A remote control  
If you touch the buttons in the order of “Menu” → “Service setting” → “Service & Maintenance” → “Service password” → “IU address” on the TOP screen of remote control, the indoor units which are connected are displayed.
- (ii) In case of RC-E5 remote control  
Pressing “AIR CON No.” button on the remote control displays the indoor unit address. If “▲” “▼” button is pressed at the next, it is displayed orderly starting from the unit of smallest No.

**(d) In case of anomaly**

If any anomaly occurs on a unit in a group (a protective function operates), that unit stops with the anomalous stop but any other normal units continue to run as they are.

**(e) Signal wiring procedure**

Signal wiring between indoor and outdoor units should be made on each unit same as the normal wiring. For the group control, connect the remote control wiring to each indoor unit via terminal block for the remote control.

Connect the remote control wiring separately from the power source cable or wires of other electric devices (AC220V or higher).

**(18) High ceiling control**

When sufficient air flow rate cannot be obtained from the indoor unit which is installed at a room with high ceiling, the air flow rate can be increased by changing the fan tap. To change the fan tap, use the indoor unit function “FAN SPEED SET” on the wired remote control.

Fan tap		Indoor unit air flow setting				Series
		●●●● - ●●●● - ●●●● - ●●●●	●●●● - ●●●● - ●●●●	●●●● - ●●●●	●●●● - ●●●●	
FAN SPEED SET	STANDARD	P-Hi1 - Hi - Me - Lo	Hi - Me - Lo	Hi - Lo	Hi - Me	Except FDT, FDE
		P-Hi2 - Hi - Me - UL0	Hi - Me - Lo	Hi - Lo	Hi - Me	Only FDT
		P-Hi2 - Hi - Me - Lo	Hi - Me - Lo	Hi - Lo	Hi - Me	Only FDE
	HIGH SPEED1	P-Hi1 - P-Hi1 - Hi - Me	P-Hi1 - Hi - Me	P-Hi1 - Me	P-Hi1 - Hi	Except FDT, FDE
		P-Hi2 - P-Hi1 - Hi - Me	P-Hi1 - Hi - Me	P-Hi1 - Me	P-Hi1 - Hi	Only FDT
		P-Hi1 - Hi - Me - Lo	Hi - Me - Lo	Hi - Lo	Hi - Me	Only FDE
HIGH SPEED2	P-Hi2 - Hi - Me - Lo	Hi - Me - Lo	Hi - Lo	Hi - Me	Only FDT, FDE	

- Notes (1) Factory default is STANDARD.
- (2) At the hot-start and heating thermostat OFF, or other, the indoor fan is operated at the low speed tap of each setting.
- (3) This function is not able to be set with wireless remote control or simple remote control (RCH-E3).

**(19) Abnormal temperature sensor (return air/indoor heat exchanger) broken wire/short-circuit detection**

**(a) Broken wire detection**

When the return air temperature sensor detects -55°C or lower or the heat exchanger temperature sensor detect -55°C or lower for 5 seconds continuously, the compressor stops. After a 3-minute delay, the compressor restarts but, if it is detected again within 60 minutes after the initial detection for 6 minutes continuously, stops again (the return air temperature sensor: E7, the heat exchanger temperature sensor: E6).

**(b) Short-circuit detection**

If the heat exchanger temperature sensor detects short-circuit for 5 seconds continuously at 2 minutes and 20 seconds after the compressor ON during cooling operation, the compressor stops (E6).

**(20) External input/output control (CnT or CnTA)**

External input/output connectors are provided on the indoor unit control PCB, and each input/output is possible to be changed by RC-EX3A.

Be sure to connect the wired remote control to the indoor unit. Remote operation with CnT/CnTA only is not possible.

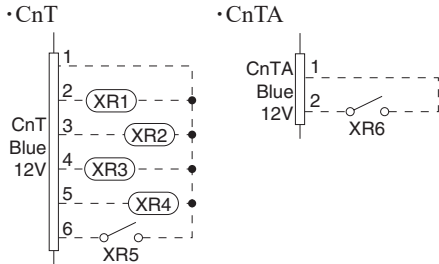

Input/Output	Connector	Factory default setting	RC-EX3A function name
Output	CnT-2 (XR1)	Operation output	External output 1
	CnT-3 (XR2)	Heating output	External output 2
	CnT-4 (XR3)	Compressor ON output	External output 3
	CnT-5 (XR4)	Inspection(Error) output	External output 4
"Input (Volt-free contact)"	CnT-6 (XR5)	Remote operation input	External input 1
	CnTA (XR6)	Remote operation input	External input 2

■ Priority order for combinations of CnT and CnTA input.

		CnTA					
		① Operation stop level	② Operation stop pulse	③ Operation permission/prohibition	④ Operation permission/prohibition pulse	⑤ Cooling/heating selection level	⑥ Cooling/heating selection pulse
CnT	① Operation stop level	CnT ①	CnT ①	CnT ① + CnTA ②	CnT ①	CnT ① / CnTA ⑤	CnT ① / CnTA ⑥
	② Operation stop pulse	CnT ②	CnT ②	CnT ② + CnTA ③	CnT ②	CnT ② / CnTA ⑤	CnT ② / CnTA ⑥
	③ Operation permission/prohibition level	CnT ③ > CnTA ①	CnT ③ > CnTA ②	CnT ③ + CnTA ③	CnT ③	CnT ③ / CnTA ⑤	CnT ③ / CnTA ⑥
	④ Operation permission/prohibition pulse	CnT ④	CnT ④	CnT ④ + CnTA ③*	CnT ④	CnT ④ / CnTA ⑤	CnT ④ / CnTA ⑥
	⑤ Cooling/heating selection level	CnT ⑤ / CnTA ①	CnT ⑤ / CnTA ②	CnT ⑤ / CnTA ③	CnT ⑤ / CnTA ④	CnT ⑤	CnT ⑤
	⑥ Cooling/heating selection pulse	CnT ⑥ / CnTA ①	CnT ⑥ / CnTA ②	CnT ⑥ / CnTA ③	CnT ⑥ / CnTA ④	CnT ⑥	CnT ⑥

Note (1) Following operation commands are accepted when the operation prohibition is set with CnTA as indicated with \*.

Individual operation command from remote control, test run command from outdoor unit and operation command from option device, CnT input.

Reference: Explanation on the codes and the combinations of codes in the table above

- In case of CnT "Number", the CnT "Number" is adopted and CnTA is invalidated.
- In case of CnTA "Number", the CnTA "Number" is adopted and CnT is invalidated.
- In case of CnT "Number"/CnTA "Number", the CnT "Number" and the CnTA "Number" become independent functions each other.
- In case of CnT "Number" + CnTA "Number", the CnT "Number" and the CnTA "Number" become competing functions each other.
- In case of CnT "Number" > CnTA "Number", the function of CnT "Number" supersedes that of CnTA "Number".
- In case of CnT "Number" < CnTA "Number", the function of CnTA "Number" supersedes that of CnT "Number".  
(The "Number" above means ① - ⑥ in the table.)

**(a) Output for external control (remote display)**

Indoor unit outputs the following signal for operation status monitoring.

	Output name	Condition
1	Operation output	During operation
2	Heating output	During heating operation
3	Compressor ON output	During compressor operation
4	Inspection(Error) output	When anomalous condition occurs.
5	Cooling output	During cooling operation
6	Fan operation output 1	When indoor fan is operating
7	Fan operation output 2	When indoor fan is operating, and fan speed is higher than Hi speed.
8	Fan operation output 3	When indoor fan is operating, and fan speed is Lower than Me speed.
9	Defrost/oil return output	When indoor unit receive defrost/oil return signal from the outdoor unit.
10	Ventilation output	When "Venti.ON" is selected from remote control
11	Free cooling output	When the ambient temperature is between 10 - 18°C in cooling and fan operation
12	Indoor unit overload alarm output	Refer to "IU overload alarm"
13	Heater output	Refer to "(8) Thermostat operation (b) Heating"

**(b) Input for external control**

The external input for the indoor unit can be selected from the following input.

	Input name	Content
1	Run/Stop	Refer to [(20) (c) Remote operation input]
2	Permission/Prohibition	Refer to [(21) Operation permission/prohibition]
3	Cooling/Heating	Refer to [(23) Selection of cooling/heating external input function]
4	Emergency stop	Indoor/outdoor units stop the operation, and [E63] is displayed.
5	Setting temperature shift	Set temperature is shifted by +2/-2°C in cooling/heating.
6	Forced thermo-OFF	Unit goes thermo off.
7	Temporary stop	Refer to [(22) Temporary stop input]
8	Silent mode	Outdoor unit silent mode is activated.

**(i) In case of “Level input” setting (Factory default)**

Input signal to CnT-6 or CnTA is OFF→ON ..... unit ON  
 Input signal to CnT-6 or CnTA is ON→OFF ..... unit OFF  
 Operation is not inverted.

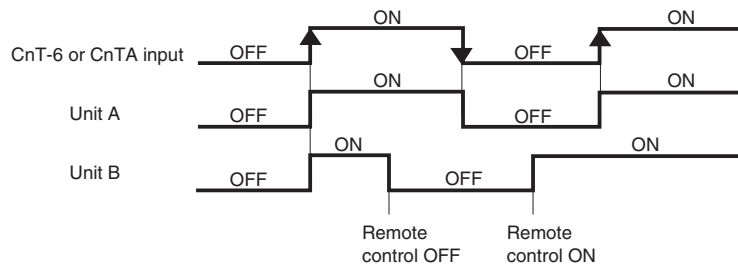

Note (1) The latest operation has priority  
 It is available to operate/stop by remote control or central control.

**(ii) In case of “Pulse input” setting (Local setting)**

It is effective only when the input signal to CnT-6 or CnTA is changed OFF→ON, and at that time unit operation [ON/OFF] is inverted.

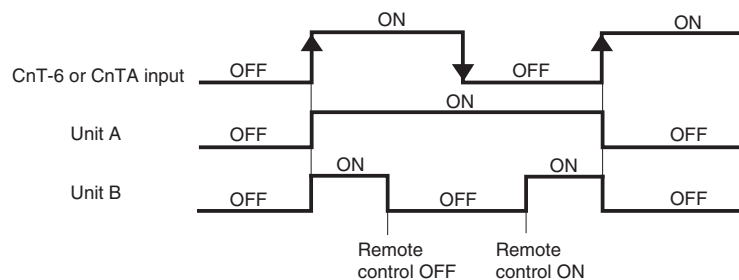

**(c) Remote operation**

**(i) In case of multiple units (Max. 16 indoor units group) are connected to one wired remote control**

When the R/C function setting of wired remote control for “External control set” is changed from “Individual (Factory default)” to “For all units”, all units connected in one wired remote control system can be controlled by external operation input.

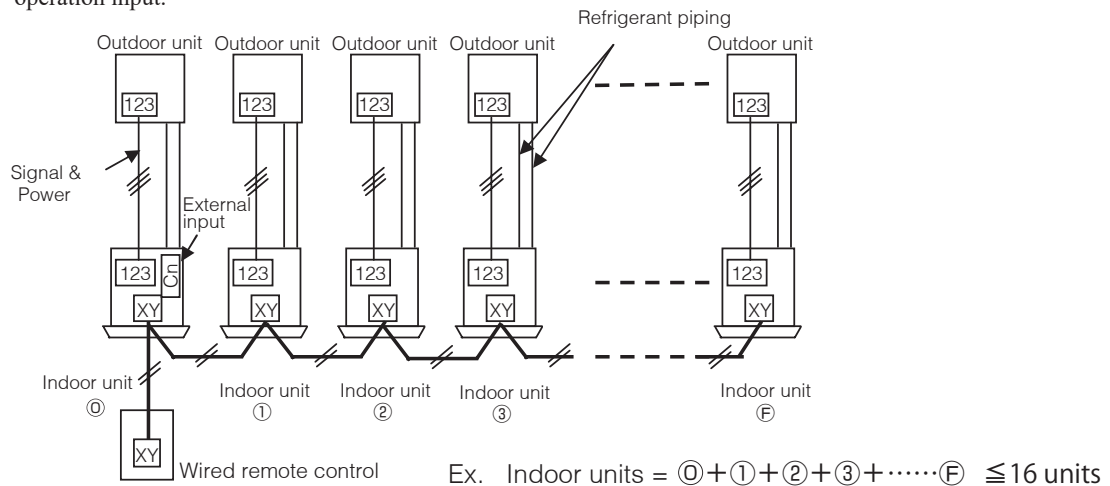

CnT-6 or CnTA	Individual operation (Factory default)		All units operation (Local setting)	
	ON	OFF	ON	OFF
	Only the unit directly connected to the remote control can be operated.	Only the unit directly connected to the remote control can be stopped operation.	All units in one remote control system can be operated.	All units in one remote control system can be stopped operation.
	Unit ① only	Unit ① only	Units ① – ㉞	Units ① – ㉞

When more than one indoor unit (Max. 16 indoor units) are connected in one wired remote control system:

- (1) With the factory default, external input to CnT-6 or CnTA is effective for only the unit ①.
- (2) When setting “For all unit” (Local setting), all units in one remote control system can be controlled by external input to CnT-6 or CnTA on the indoor unit ①.
- (3) External input to CnT-6 or CnTA on the other indoor unit than the unit ① is not effective.

**(21) Operation permission/prohibition**

**(In case of adopting card key switches or commercially available timers)**

When the indoor function setting of wired remote control for “Operation permission/prohibition” is changed from “Invalid (Factory default)” to “Valid”, following control becomes effective.

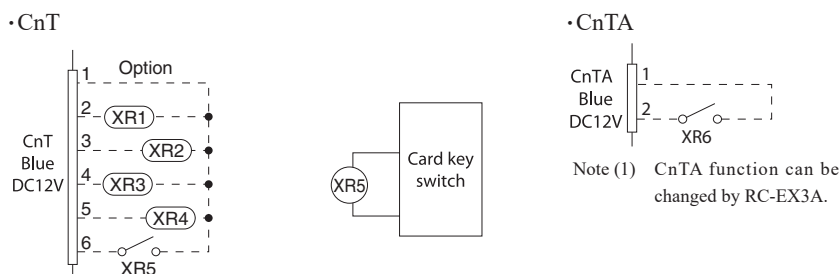

CnT-6 or CnTA	Normal operation (Factory default)		Operation permission/prohibition mode “Valid” (Local setting)	
	ON	OFF	ON	OFF
	Operation	Stop	Operation permission*1	Operation prohibition (Unit stops)

\*1 **Only the “LEVEL INPUT” is acceptable for external input**, however when the indoor function setting of “Level input (Factory default)” or “Pulse input” is selected by the function for “External input” of the wired remote control, operation status will be changed as follows.

In case of “Level input” setting	In case of “Pulse input” setting
Unit operation from the wired remote control becomes available ※1	Unit starts operation ※2

※1) In case that “Operation permission/prohibition mode” setting is “Valid” and “External input” setting is “Level input (Factory default)”;

- ① When card key switch is ON (CnT-6 or CnTA ON: Operation permission), start/stop operation of the unit from the wired remote control becomes available.
- ② When card key switch is OFF (CnT-6 or CnTA OFF: Operation prohibition), the unit stops operation in conjunction with OFF signal, and start/stop operation of the unit from the wired remote control becomes unavailable.

※2) In case that “Operation permission/prohibition mode” setting is “Valid” and “External input” setting is “Pulse input (Local setting)”;

- ① When card key switch is ON (Operation permission), the unit starts operation in conjunction with ON signal, and also start/stop operation of the unit from the wired remote control becomes available.
- ② When card key switch is OFF (Operation prohibition), the unit stops operation in conjunction with OFF signal, and start/stop operation of the unit from the wired remote control becomes unavailable.

3) This function is invalid only at “Center mode” setting done by central control.

**(a) In case of CnT ① Operation stop level > CnTA ③ Operation permission/prohibition level**

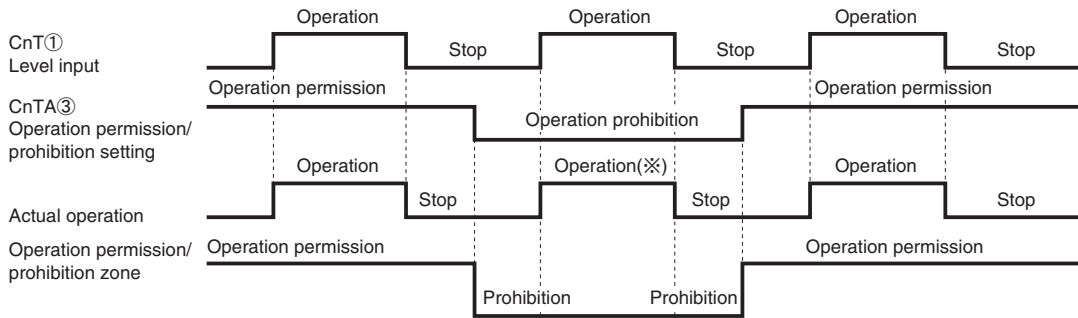

(※) CnT level input supersedes CnTA operation prohibition.

**(b) In case of CnT ③ Operation permission/prohibition level + CnTA ③ Operation permission/prohibition level**

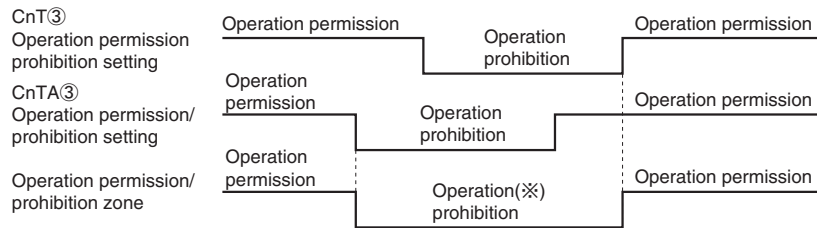

(※) Operation prohibition zone is determined by the OR judgment between CnT operation prohibition zone and CnTA operation prohibition zone.

**(c) In case of CnT ③ Operation permission/prohibition level > CnTA ② Operation/stop pulse**

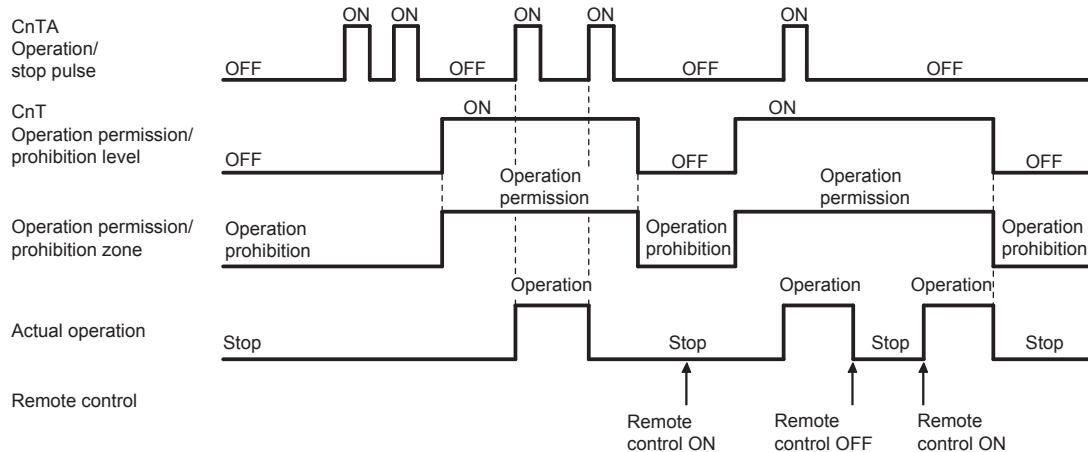

Note (1) If it is prohibited by CnT, all "Operation" and "Stop" commands are not accepted.

**(d) In case of CnT ② Operation/stop pulse + CnTA ③ Operation permission/prohibition level**

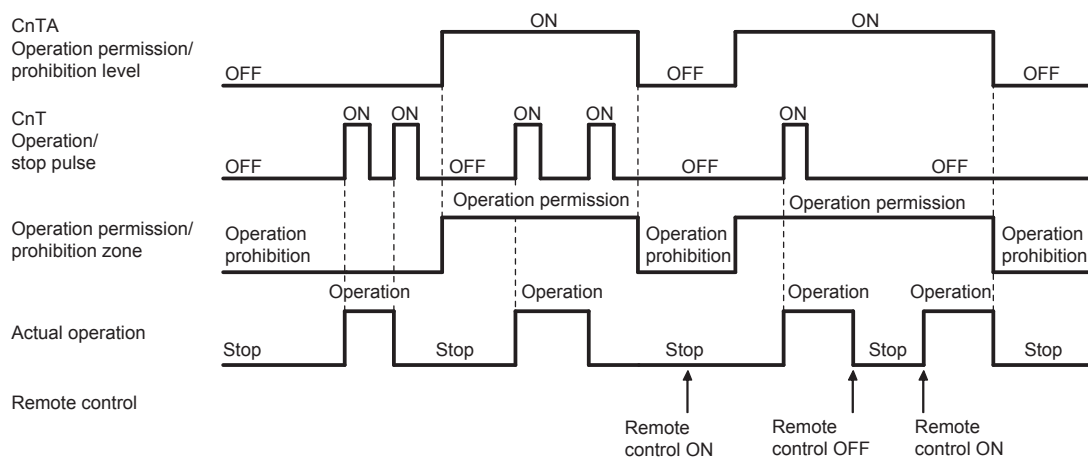



**(22) Temporary stop input**

In case of temporary stop, operation lamp of remote control lights, but indoor/outdoor unit stop the operation.

**(a) In case of “level input” setting (Factory default)**

Input signal to CnT-6 or CnTA is OFF → ON : Temporary stop  
 Input signal to CnT-6 or CnTA is OFF → ON : Normal operation

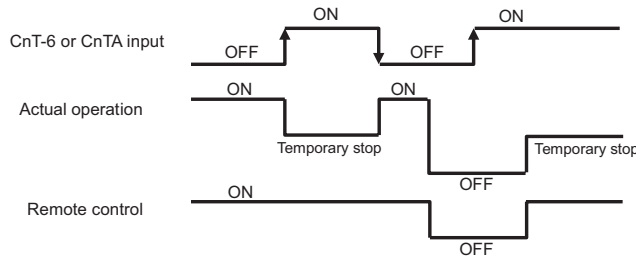

**(b) In case of “pulse input” setting (Local setting)**

It is effective only when the input signal is changed OFF→ON, and “temporary stop/normal operation” is inverted.

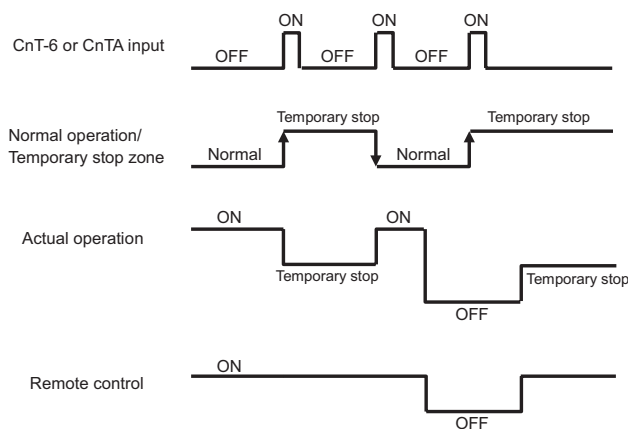

**(23) Selection of cooling/heating external input function**

- (a) When “External input 1 setting: Cooling/heating” is set by the indoor unit function from remote control, the cooling or heating is selected with CnT-6 or CnTA.
- (b) When the external input 1 method selection: Level input is set by the indoor unit function:
  - CnT-6 or CnTA: OPEN → Cooling operation mode
  - CnT-6 or CnTA: CLOSE → Heating operation mode
- (c) When the external input 1 method selection: Pulse input is set by the indoor unit function:
  - If the external input is changed OPEN → CLOSE, operation modes are inverted (Cooling → Heating or Heating → Cooling).
- (d) If the cooling/heating selection signal is given by the external input, the operation mode is transmitted to the remote control.

■ Selection of cooling/heating external input function

External input selection	External input method	Operation	
		External terminal input (CnT or CnTA)	Operation
Cooling/heating selection	⑤ Level	External terminal input (CnT or CnTA)	
		Cooling/heating	
	Cooling/heating (Competitive)		
	⑥ Pulse	External terminal input (CnT or CnTA)	
Cooling/heating			
Cooling/heating (Competitive)			

Note (1) Regarding the priority order for combinations of CnT and CnTA, refer to Page 20.

**(24) Fan control at heating startup**

**(a) Starting conditions**

At the start of heating operation, if the difference of setting temperature and return air temperature is 5°C or higher after the end of hot start control, this control is performed.

**(b) Contents of control**

- (i) Sampling is made at each minute and, when the indoor heat exchanger temperature (detected with Thi-R) is 37°C or higher, present number of revolutions of indoor fan speed is increased by 10min<sup>-1</sup>.
- (ii) If the indoor heat exchanger temperature drops below 37°C at next sampling, present number of revolutions of indoor fan speed is reduced by 10min<sup>-1</sup>.

**(c) Ending conditions**

Indoor fan speed is reduced to the setting air flow volume when the compressor OFF is established and at 30 minutes after the start of heating operation.

**(25) Room air temperature detection temperature compensation during heating**

With the standard specification, the compressor is turned ON/OFF with the thermostat setting temperature. When the thermostat is likely to turn OFF earlier because the unit is installed at the ceiling where warm air tends to accumulate, the setting can be changed with the wired remote control indoor unit function “SP OFFSET”. The compressor and the heater are turned ON/OFF at one of the setting temperature +3, +2 or +1°C in order to improve the feeling of heating. The setting temperature, however, has the upper limit of 30°C.

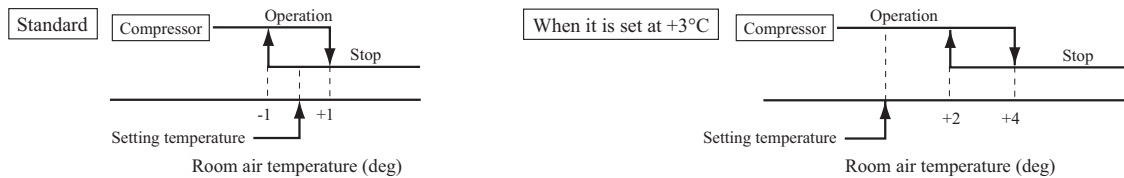

**(26) Return air temperature compensation**

This is the function to compensate the deviation between the detection temperature by the return air temperature sensor and the measured temperature after installing the unit.

- (a) It is adjustable in the unit of 0.5°C with the wired remote control indoor unit function “RETURN AIR TEMP”.
  - +1.0°C, +1.5°C, +2.0°C
  - -1.0°C, -1.5°C, -2.0°C
- (b) Compensated temperature is transmitted to the remote control and the compressor to control them.

Note (1) The detection temperature compensation is effective on the indoor unit temperature sensor only.

**(27) High power operation (RC-EX3A only)**

It operates at with the set temperature fixed at 16°C for cooling, 30°C for heating and maximum indoor fan speed for 15 minutes maximum.

**(28) Energy-saving operation (RC-EX3A only)**

It operates with the setting temperature fixed at 28°C for cooling, 22°C for heating or 25°C for auto. When fan control in cooling/heating thermo-OFF setting is “Set fan speed”, fan speed during thermo-OFF is changed to “Low”. (Maximum capacity is restricted at 80%.)

**(29) Warm-up control (RC-EX3A only)**

Operation will be started 5 to 60 minutes before use according to the forecast made by the microcomputer which calculates when the operation should be started in order to warm up the indoor air temperature near the setting temperature at the setting time of operation start.

**(30) Home leave mode (RC-EX3A only)**

When the unit is not used for a long period of time, the room air temperature is maintained at a moderate level, avoiding extremely hot or cool temperature.

- (a) Cooling or heating is operated according to the outdoor air temperature (factory setting 35°C for cooling, 0°C for heating) and the setting temperature. (factory setting 33°C for cooling, 10°C for heating)
- (b) Setting temperature and indoor fan speed can be set by RC-EX3A.

**(31) Auto temperature setting (RC-EX3A only)**

Setting temperature is adjusted automatically at the adequate temperature the center setting temperature is 24°C by correcting the outdoor air temperature.

**(32) Fan circulator operation (RC-EX3A only)**

When the fan is used for circulation, the unit is operated as follows depending on the setting with the remote control.

- (a) If the invalid is selected with the remote control, the fan is operated continuously during the fan operation. (normal fan mode)
- (b) If the valid is selected with the remote control, the fan is operated or stopped when on the difference of the remote control temperature sensor and the return air temperature sensor becomes bigger than 3°C.

**(33) The operation judgment is executed every 5 minutes (RC-EX3A only)**

Setting temperature  $T_s$  is changed according to outdoor air temperature.

This control is valid with cooling and heating mode. (Not auto mode)

- (a) Operate 5 minutes forcedly.
- (b) Setting temperature is adjusted every 10 minutes.
  - (i) Cooling mode.  
 $T_s = \text{outdoor air temperature} - \text{offset value}$
  - (ii) Heating mode.  
 $T_s = \text{outdoor air temperature} - \text{offset value}$
- (c) If the return air temperature lower than 18°C in cooling or return air temperature becomes higher than 25°C in heating, unit goes thermostat OFF.

**(34) Auto fan speed control (RC-EX3A only)**

In order to reach the room air temperature to the set temperature as quickly as possible, the air flow rate is increased when the set temperature of thermostat differs largely from the return air temperature. According to temperature difference between set temperature and return air temperature, indoor fan tap are controlled automatically.

- Auto 1: Changes the indoor fan tap within the range of Hi ↔ Me ↔ Lo.
- Auto 2: Changes the indoor fan tap within the range of P-Hi ↔ Hi ↔ Me ↔ Lo.

**(35) Indoor unit overload alarm (RC-EX3A only)**

If the following condition is satisfied at 30 minutes after starting operation, RC-EX3A shows maintenance code "M07" and the signal is transmitted to the external output (CnT-2-5).

- Cooling, Dry, Auto(Cooling) : Indoor air temperature = Set room temperature by remote control + Alarm temperature difference
  - Heating, Auto(Heating) : Indoor air temperature = Set room temperature by remote control - Alarm temperature difference
- Alarm temperature difference is selectable between 5 to 10°C.

If the following condition is satisfied or unit is stopped, the signal is disappeared.

- Cooling, Dry, Auto(Cooling) : Indoor air temperature = Set room temperature + Alarm temperature difference - 2°C
- Heating, Auto(Heating) : Indoor air temperature = Set room temperature - Alarm temperature difference + 2°C

**(36) Peak-cut timer (RC-EX3A only)**

Power consumption can be reduced by restricting the maximum capacity.

Set the [Start time], the [End time] and the capacity limit % (Peak-cut %).

- 4-operation patterns per day can be set at maximum.
- The setting time can be changed by 5-minutes interval.
- The selectable range of capacity limit % (Peak-cut %) is from 0% to 40-80% (20% interval).
- Holiday setting is available.

**(37) Motion sensor control (RC-EX3A and RCN-E2 only)**

The sensor determines the presence of people and the amount of activity, and the following controls are done by the motion sensor.

Following settings are necessary to activate motion sensor control.

- (a) Infrared (motion) sensor setting: Installation setting of remote control  
The indoor unit which is set to “Enable” become valid.
- (b) Infrared (motion) sensor control: Energy-saving setting of remote control  
The function which is set to “Enable” become valid.

**RC-EX3A**

TOP screen **Menu** ⇒ **Service setting** ⇒ **Installation settings** ⇒ **Service password**

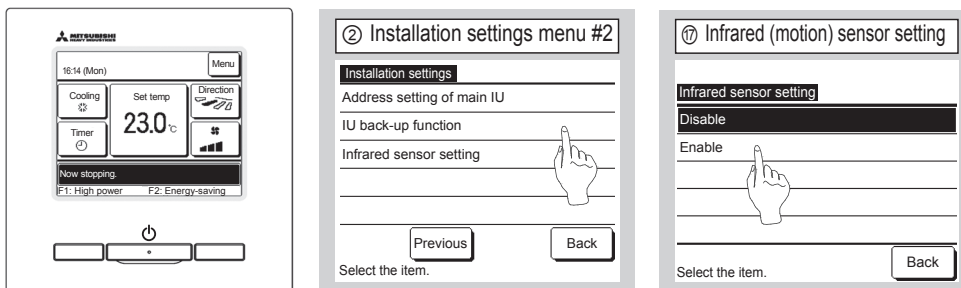

TOP screen **Menu** ⇒ **Energy-saving setting** ⇒ **Infrared sensor control** or **Motion sensor control**

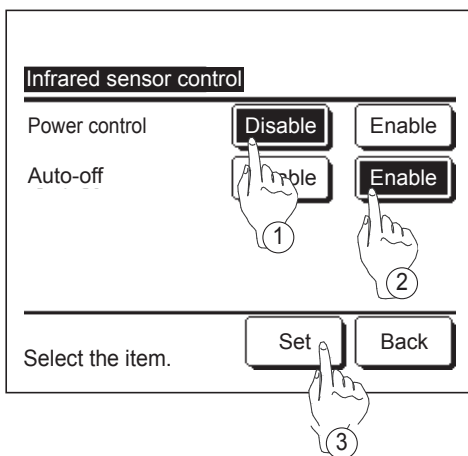

The Infrared sensor control screen and contents of the current settings are displayed.

- ① Enable/disable power control.
- ② Enable/disable auto-off.
- ③ After you set each item, tap the **Set** button.  
The display returns to the Energy-saving setting menu screen.

**RCN-E2**

**1. Set indoor functions**

- ① Press the ON/OFF button to stop the unit.
- ② Press the desired one of the buttons shown item 2. while holding down the FUNCTION SETTING switch.
- ③ Use the selection buttons, ▲ and ▼, to change the setting.
- ④ Press the SET button.  
The buzzer on the remote control signal receiver beeps twice, and the LED lamp flashes four times at two-second intervals.

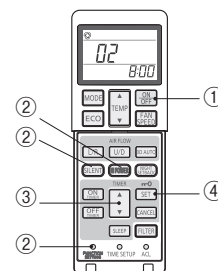

**2. Setting details**

Button	Number indicator	Function setting
SILENT	00	Infrared sensor setting (Motion sensor setting) : Disable
	01	Infrared sensor setting (Motion sensor setting) : Enable
HI POWER	00	Infrared sensor control (Motion sensor control) : Disable
	01	Infrared sensor control (Motion sensor control) : Power control only
	02	Infrared sensor control (Motion sensor control) : Auto OFF only
	03	Infrared sensor control (Motion sensor control) : Power control and Auto OFF

(i) Power saving / comfort control

The set temperature is adjusted according to the presence of people and their amount of activity detected by the infrared (motion) sensor.

MODE:AUTO/COOL/HEAT mode operation

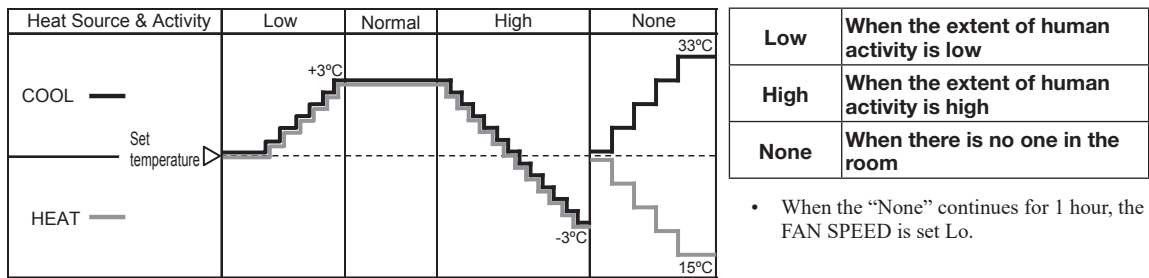

Notes (1) When the following operations are set, power saving control will be canceled.

- ① Energy-saving, Home leave mode, Warm-up control, Cooling operation check.
- ② When the operation mode is changed DRY or FAN.

(2) Not operable while the air-conditioner is OFF.

(ii) Auto-off control

When no activity is detected for 1 hour, unit will go stand-by mode.※ Unit will re-start operation automatically with the original set temperature by activity detection during the stand-by mode. When stand-by mode continues for 12 hours, unit stops.

※ Compressor keeps stopped regardless of the set temperature.

## (II) SRK series

### (1) Unit ON/OFF button

When the wireless remote control batteries become weak, or if the wireless remote control is lost or malfunctioning, this button may be used to turn the unit on and off.

#### (a) Operation

Push the button once to place the unit in the automatic mode. Push it once more to turn the unit off.

#### (b) Details of operation

The unit will go into the automatic mode in which it automatically determines, from indoor temperature (as detected by sensor), whether to go into COOL, DRY or HEAT modes.

Function	Indoor temperature setting	Fan speed	Flap/Louver	Timer switch
Operation mode				
COOL	About 24°C	Auto	Auto	Continuous
DRY				
HEAT				

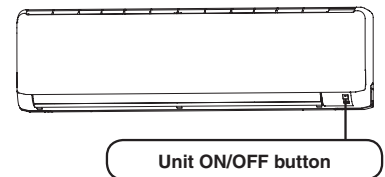

### (2) Auto restart function

(a) Auto restart function records the operational status of the air-conditioner immediately prior to be switched off by a power cut, and then automatically resumes operations after the power has been restored.

(b) The following settings will be cancelled:

- (i) Timer settings
- (ii) HIGH POWER operations

Notes (1) Auto restart function is set at on when the air-conditioner is shipped from the factory. Consult with your dealer if this function needs to be switched off.  
 (2) When power failure occurs, the timer setting is cancelled. Once power is resumed, reset the timer.  
 (3) If the jumper wire (JA1) "AUTO RESTART" is cut, auto restart is disabled. (See the diagram at right)

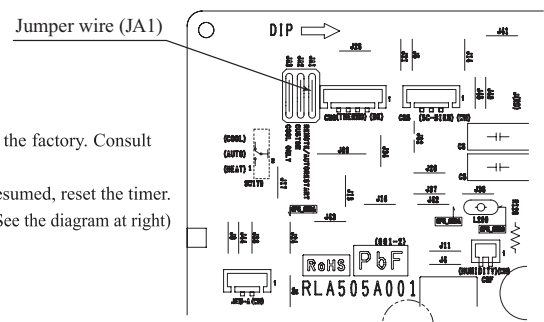

### (3) Installing two air-conditioners in the same room

When two air-conditioners are installed in the room, use setting when the two air-conditioners are not operated with one wireless remote control. Set the wireless remote control and indoor unit.

#### (a) Setting the wireless remote control

- (i) Pull out the cover and take out batteries.
- (ii) Disconnect the switching line next to the battery with wire cutters.
- (iii) Insert batteries, Close the cover.

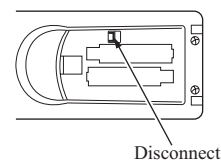

#### (b) Setting an indoor unit

- (i) Turn off the power source, and turn it on after 1 minute.
- (ii) Point the wireless remote control that was set according to the procedure described on the left side at the indoor unit and send a signal by pressing the ACL switch on the wireless remote control.  
 Since the signal is sent in about 6 seconds after the ACL switch is pressed, point the wireless remote control at the indoor unit for some time.
- (iii) Check that the reception buzzer sound "Peep" is emitted from the indoor unit.  
 At completion of the setting, the indoor unit emits a buzzer sound "Peep".  
 (If no reception tone is emitted, start the setting from the beginning again.)

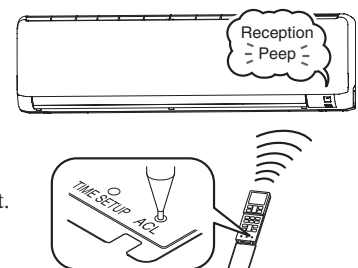

**(4) Selection of the annual cooling function**

**(a) The annual cooling control is valid from factory default setting. It is possible to disable by cutting jumper wire (JA3), or changing the setting of DIP switch (SW2-4) on the interface kit (Option) PCB if it is connected.**

Jumper wire (JA3)	Interface kit (SC-BIKN2-E) SW2-4	Function
Shorted	ON	Enabled factory default setting
Shorted	OFF	Disabled
Open	ON	Disabled
Open	OFF	Disabled

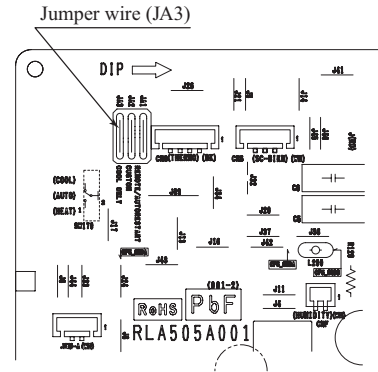

Notes: (1) Default states of the jumper wire (JA3) and the interface kit at the shipping from factory –On the PCB, the DIP switch (SW2-4) is set to enable the annual cooling function.

(2) To cancel the annual cooling setting, consult your dealer.

**(b) Content of control**

- (i) If the outdoor air temperature sensor (TH2) detects below 5°C, the indoor fan speed is switched to 8th step. (It is not possible to change.)
- (ii) If the outdoor air temperature sensor (TH2) detects higher than 7°C, the indoor fan speed is changed to the normal control speed.

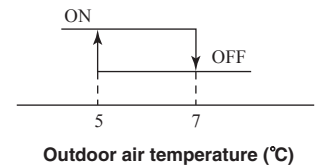

**(5) High power operation**

Pressing the HI/ECO button intensifies the operating power and initiates powerful cooling or heating operation for 15 minutes continuously. The wireless remote control displays HIGH POWER mark and the FAN SPEED display disappears.

- (a) During the HIGH POWER operation, the room temperature is not controlled. When it causes an excessive cooling or heating, press the HI/ECO button again to cancel the HIGH POWER operation.
- (b) HIGH POWER operation is not available during dehumidifying and the program timer operations.
- (c) When HIGH POWER operation is set after setting ON TIMER operation, HIGH POWER operation will start from the set time.
- (d) When the following operation are set, HIGH POWER operation will be canceled.
  - ① When the HI/ECO button is pressed again. (The operation mode will be changed to the ECONOMY operation.)
  - ② When the operation mode is changed.
  - ③ When it has been 15 minutes since HIGH POWER operation has started.
  - ④ When the 3D AUTO button is pressed.
  - ⑤ When the SILENT button is pressed.
  - ⑥ When the NIGHT SETBACK button is pressed.
- (e) Not operable while the air-conditioner is OFF.
- (f) After HIGH POWER operation, the sound of refrigerant flowing may be heard.

**(6) Economy operation**

Pressing the HI/ECO button initiate a soft operation with the power suppressed in order to avoid an excessive cooling or heating.

The unit operates 1.5°C higher than the setting temperature during cooling or 2.5°C lower than that during heating. The wireless remote control displays ECONO mark and the FAN SPEED display disappears.

- (a) It will go into ECONOMY operation at the next time the air-conditioner runs in the following cases.
  - ① When the air-conditioner is stopped by ON/OFF button during ECONOMY operation.
  - ② When the air-conditioner is stopped in SLEEP or OFF TIMER operation during ECONOMY operation.
  - ③ When the operation is retrieved from SELF CLEAN or ALLERGEN CLEAR operation.
- (b) When the following operation are set, ECONOMY operation will be canceled.
  - ① When the HI/ECO button is pressed again.
  - ② When the operation mode is changed from DRY to FAN.
  - ③ When the NIGHT SETBACK button is pressed.
- (c) Not operable while the air-conditioner is OFF.

(d) The setting temperature is adjusted according to the following table.

(Unit : deg°C)

Item	Mode	Cooling	Heating
Temperature adjustment	①	+0.5	-1.0
	②	+1.0	-2.0
	③	1.0+Figure A	-2.0+Figure B

- ① at the start of operation.
- ② one hour after the start of operation.
- ③ two hours after the start of operation.

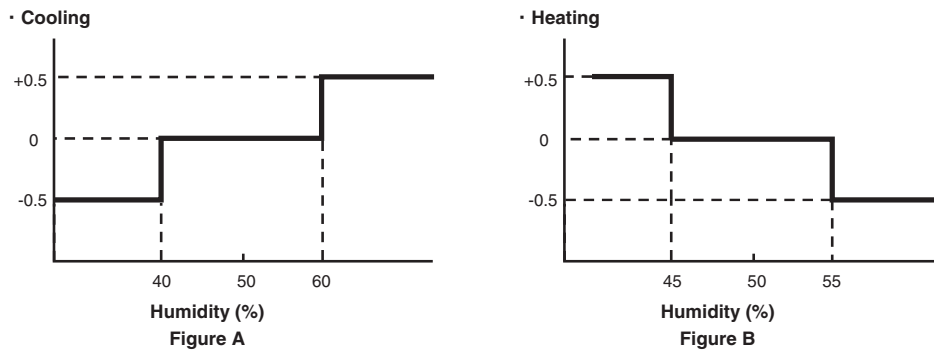

**(7) Flap and louver control**

Control the flap and louver by AIR FLOW U/D (UP/DOWN) and L/R (LEFT/RIGHT) button on the wireless remote control.

**(a) Flap**

Each time when you press the AIR FLOW U/D (UP/DOWN) button the mode changes as follows.

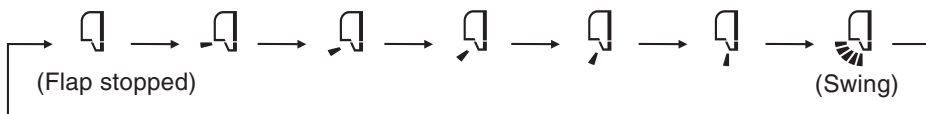

• Angle of Flap from Horizontal

Remote control display					
COOL , DRY, FAN	Approx. 5°	Approx. 20°	Approx. 35°	Approx. 50°	Approx. 70°
HEAT	Approx. 20°	Approx. 35°	Approx. 45°	Approx. 60°	Approx. 70°

**(b) Louver**

Each time when you press the AIR FLOW L/R (LEFT/RIGHT) button the mode changes as follows.

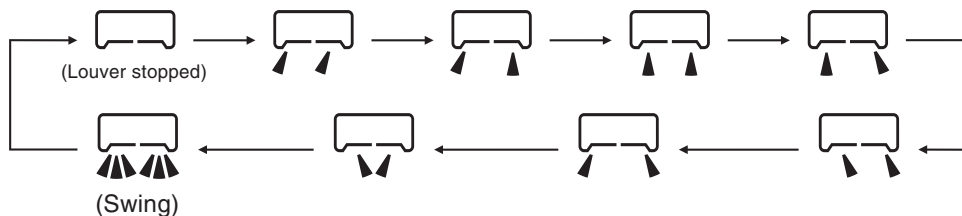

• Angle of Louver

Remote control display					
Center installation	Left approx. 50°	Left approx. 20°	Center	Right approx. 20°	Right approx. 50°
Right end installation	Left approx. 50°	Left approx. 45°	Left approx. 30°	Center	Right approx. 20°
Left end installation	Left approx. 20°	Center	Right approx. 30°	Right approx. 45°	Right approx. 50°



**(c) Swing**

(i) Swing flap

Flap moves in upward and downward directions continuously.

◆ In HEAT operation

◆ In COOL, DRY, FAN operation

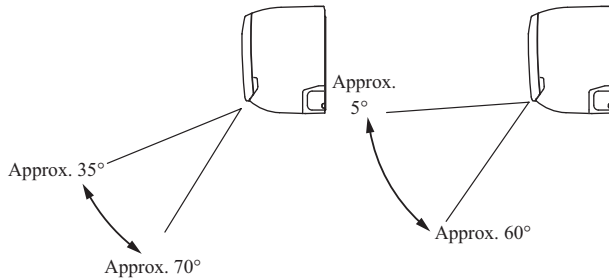

(ii) Swing louver

Louver moves in left and right directions continuously.



**(d) Memory flap (Flap or Louver stopped)**

When you press the AIR FLOW (UP/DOWN or LEFT/RIGHT) button once while the flap or louver is operating, it stops swinging at the position. Since this angle is memorized in the microcomputer, the flap or louver will automatically be set at this angle when the next operation is started.

**(e) When not operating**

The flap returns to the position of air flow directly below, when operation has stopped.

**(8) 3D auto operation**

Control the flap and louver by 3D AUTO button on the wireless remote control.

Air flow selection and air flow direction are automatically controlled, allowing the entire indoor to efficiently conditioned.

(a) During cooling and heating (Including auto cooling and heating)

(i) Air flow selection is determined according to indoor temperature and setting temperature.

Operation mode	Air flow selection					
	AUTO		HI	MED	LO	ULO
Cooling	Indoor temp. – Setting temp. >5°C	Indoor temp. – Setting temp. ≤ 5°C	HI	MED	LO	ULO
	HIGH POWER	AUTO				
Heating	Setting temp. – Indoor temp. >5°C	Setting temp. – Indoor temp. ≤ 5°C				
	HIGH POWER	AUTO				

(ii) Air flow direction is controlled according to the indoor temperature and setting temperature.

1) When 3D auto operation starts

	Cooling	Heating
Flap	Up/down swing	
Louver	Wide (Fixed)	Center (Fixed)

2) When Indoor temp. – Setting temp. is ≤ 5°C during cooling and when Setting temp. – Indoor temp. is ≤ 5°C during heating, the system switches to the following air flow direction control. After the louver swings left and right symmetrically for 3 cycles, control is switched to the control in 3).

	Cooling	Heating
Flap	Horizontal blowing (Fixed)	Slant forward blowing (Fixed)
Louver	Left/right swing	

3) After the flap swings for 5 cycles, control is switched to the control in 4).

	Cooling	Heating
Flap	Up/down swing	
Louver	Center (Fixed)	

- 4) For 5 minutes, the following air flow direction control is carried out.

	<b>Cooling</b>	<b>Heating</b>
<b>Flap</b>	Horizontal blowing (Fixed)	Slant forwardl blowing (Fixed)
<b>Louver</b>	Wide (Fixed)	

- 5) After 5 minutes have passed, the air flow direction is determined according to the indoor temperature and setting temperature.

<b>Operation mode</b>	<b>Air flow direction control</b>		
<b>Cooling</b>	Indoor temp. – Setting temp. $\leq 2^{\circ}\text{C}$	$2^{\circ}\text{C} < \text{Indoor temp.} - \text{Setting temp.} \leq 5^{\circ}\text{C}$	Indoor temp. – Setting temp. $> 5^{\circ}\text{C}$
	The control in 4) continues.	Control returns to the control in 2).	Control returns to the control in 1).
<b>Heating</b>	Setting temp. – Indoor temp. $\leq 2^{\circ}\text{C}$	$2^{\circ}\text{C} < \text{Setting temp.} - \text{Indoor temp.} \leq 5^{\circ}\text{C}$	Setting temp. – Indoor temp. $> 5^{\circ}\text{C}$
	The control in 4) continues.	Control returns to the control in 2).	Control returns to the control in 1).

- (b) During dehumidifying operation (Including auto dehumidifying operation)

<b>Flap</b>	Horizontal blowing (Fixed)
<b>Louver</b>	Wide (Fixed)

## (9) Timer operation

### (a) Comfortable timer setting (ON timer)

The unit starts the operation 5 to 60 minutes earlier so that the room can approach optimum temperature at ON timer.

### (b) Sleep timer operation

Pressing the SLEEP button causes the temperature to be controlled with respect to the set temperature.

### (c) OFF timer operation

The Off timer can be set at a specific time (in 10-minute units) within a 24-hour period.

### (d) Weekly timer operation

Timer operation (ON timer, OFF timer) can be set up to 4 times a day for each weekday.

## (10) Night setback

As “Night setback” signal is received from the wireless remote control, the heating operation starts with the setting temperature at  $10^{\circ}\text{C}$ .

**(11) Installation location setting**

When the indoor unit is installed at the end of a room, control the air flow direction so that it is not toward the side walls. If you set the wireless remote control installation position, keep it so that the air flow is within the range shown in the following figure.

**(a) Setting**

**(i) If the air-conditioning unit is running, press the ON/OFF button to stop.**

The installation location setting cannot be made while the unit is running.

**(ii) Press the AIR FLOW U/D (UP/DOWN) button and the AIR FLOW L/R (LEFT/RIGHT) button together for 5 seconds or more.**

The installation location display illuminates.

**(iii) Setting the air-conditioning installation location.**

Press the AIR FLOW L/R (LEFT/RIGHT) button and adjust to the desired location.

Each time the AIR FLOW L/R (LEFT/RIGHT) button is pressed, the indicator is switched in the order of:

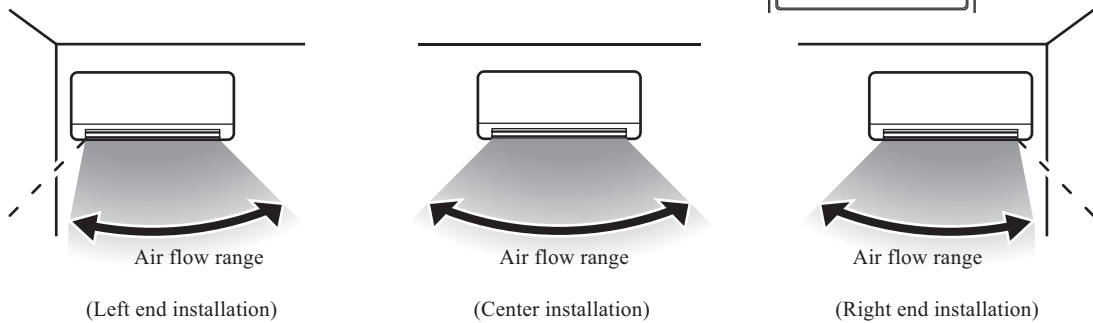
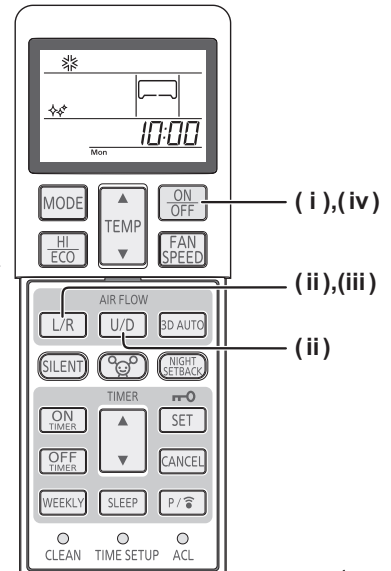

**(iv) Press the ON/OFF button.**

The air-conditioner's installation location is set.

Press within 60 seconds of setting the installation location (while the installation location setting display illuminates).

**(12) Outline of heating operation**

**(a) Operation of major functional components in heating mode**

	Heating		
	Thermostat ON	Thermostat OFF	Failure
Compressor	ON	OFF	OFF
Indoor fan motor	ON	ON(HOT KEEP)	OFF
Outdoor fan motor	ON	OFF (few minutes ON)	OFF
4-way valve	ON	ON	OFF (3 minutes ON)

**(b) Details of control at each operation mode (pattern)**

**(i) Fuzzy operation**

Deviation between the indoor temperature setting correction temperature and the return air temperature is calculated in accordance with the fuzzy rule, and used for control of the air capacity and the compressor speed.

Fan speed \ Model	SRK100ZR-W
AUTO	12-120rps
HI	12-120rps
MED	12-120rps
LO	12-106rps
ULO	12-70rps

When the defrosting, protection device, etc. is actuated, operation is performed in the corresponding mode.

**(ii) Hot keep operation**

If the hot keep operation is selected during the heating operation, the indoor fan motor is controlled based on the temperature of the indoor heat exchanger (Th2) to prevent blowing of cool wind.

**(13) Outline of cooling operation**

**(a) Operation of major functional components in cooling mode**

	Cooling		
	Thermostat ON	Thermostat OFF	Failure
Compressor	ON	OFF	OFF
Indoor fan motor	ON	ON	OFF
Outdoor fan motor	ON	OFF (few minutes ON)	OFF (few minutes ON)
4-way valve	OFF	OFF	OFF

**(b) Detail of control in each mode (Pattern)**

**1) Fuzzy operation**

During the fuzzy operation, the air flow and the compressor speed are controlled by calculating the difference between the indoor temperature setting correction temperature and the return air temperature.

Fan speed \ Model	SRK100ZR-W
AUTO	12-110rps
HI	12-110rps
MED	12-88rps
LO	12-72rps
ULO	12-40rps

**(14) Outline of dry(dehumidifying) operation**

**(a) Purpose of DRY mode**

The purpose is "Dehumidification", and not to control the humidity to the target condition. Indoor/outdoor unit control the operation condition to reduce the humidity, and also prevent over cooling.

**(b) Outline of control**

(i) Indoor unit fan speed and compressor are controlled by the area which is selected by the temperature difference.

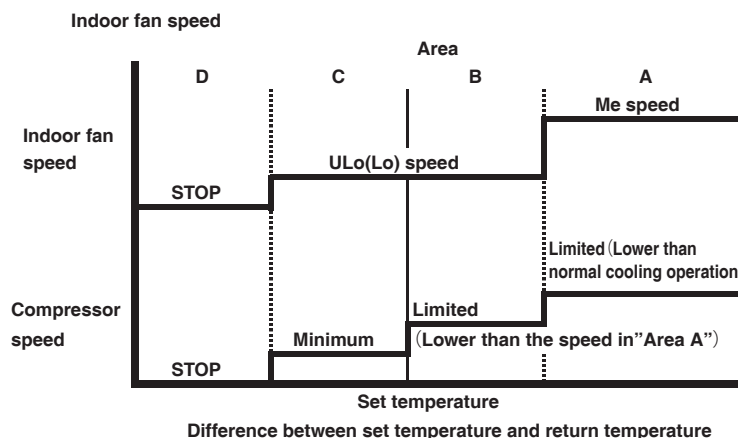

(ii) The indoor unit check the current area by every 5 minutes, and operate by the next checking.

**(c) Other**

When the outside temperature and room temperature is low for cooling operation, indoor unit can not operate in cooling, and dehumidifying. In this case, the units operate in heating to rise the room temperature and after that start dehumidifying operation.

**(15) Outline of automatic operation**

**(a) Determination of operation mode**

Operation mode is determined by indoor air temperature and outdoor air temperature as following.

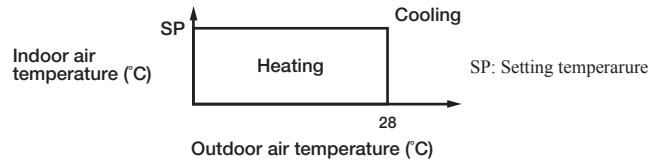

**(b) Operation mode is changes when keep cooling and heating thermostat off 20 minutes and be satisfied with following conditions.**

If the setting temperature is changed with the remote control, the operation mode is judged immediately.

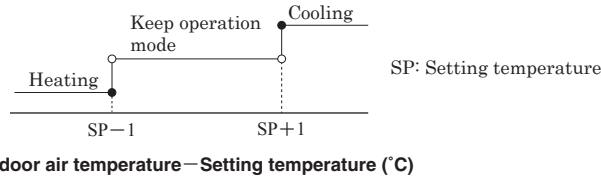

※It can not be changed to heating mode if outdoor air temperature is 28°C or higher.

**(c) When the unit is started again within one hour after the stop of automatic operation or when the automatic operation is selected during heating, cooling or DRY mode, the unit is operated in the previous operation mode.**

**(d) Setting temperature can be adjusted within the following range. There is the relationship as shown below between the signals of the wireless remote control and the setting temperature.**

Unit : °C

		Signals of wireless remote control (Display)												
		-6	-5	-4	-3	-2	-1	±0	+1	+2	+3	+4	+5	+6
Setting temperature	Cooling	18	19	20	21	22	23	24	25	26	27	28	29	30
	Heating	18	19	20	21	22	23	24	25	26	27	28	29	30

**(16) Protection control function**

**(a) Dew prevention control [Cooling]: Prevents dewing on the indoor unit.**

**(i) Operating conditions**

When the following conditions have been satisfied for more than 30 minutes after starting operation.

- 1) Compressor's command speed is 28 rps or higher.
- 2) Detected value of humidity is 68% or higher.

**(ii) Contents of operation**

1) Air capacity control

	<b>Model</b>	<b>SRK100ZR-W</b>
<b>Item</b>	<b>Range A</b>	Follow the table below
Upper limit of compressor's command speed <sup>(1)</sup>	<b>Range B</b>	56rps

Note (1) **Ranges A and B** are as shown below.

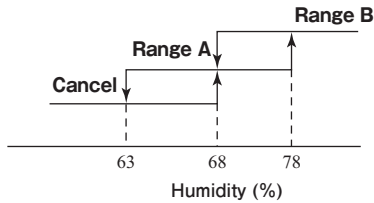

● **Condition for Range A**

Compressor's command speed is controlled according to the indoor unit heat exchanger temperature (Th2) and the indoor unit room temperature (Th1).

Condition	Compressor's command speed
$Th2 \leq Th1 - 10$	<ul style="list-style-type: none"> <li>Decreases the compressor's target max speed by 4 rps.</li> <li>If the condition is met still 20 seconds later, the speed is decreased further by 4 rps. This process is repeated further so far as the condition is met. (Lower limit is 30 rps.)</li> </ul>
$Th1 - 10 < Th2 \leq Th1 - 6$	Compressor's target max. speed or changed value of the same is maintained.
$Th2 - 6 < Th1$	Changed compressor's target max. speed is increased at a rate of 1 rps/20 seconds.

- 2) When this control has continued for more than 30 minutes continuously, the following wind direction control is performed.
- When the vertical wind direction is set at other than the vertical swing, the flaps change to the horizontal position.
  - When the horizontal wind direction is set at other than the horizontal swing, the louver changes to the vertical position.

**(iii) Reset conditions**

When any of followings is satisfied.

- Compressor's command speed is less than 28 rps.
- Detected value of humidity is less than 63%.

**(b) Frost prevention control** (During cooling or dehumidifying)

**(i) Operating conditions**

- Indoor heat exchanger temperature (Th2) is lower than 5°C.
- 5 minutes after reaching the compressor command speed except 0 rps.

**(ii) Detail of anti-frost operation**

Indoor heat exchanger temperature	5°C or lower	2.5°C or lower
<b>Item</b>		
Lower limit of compressor command speed	12 rps	0 rps
<b>Indoor fan</b>	Depends on operation mode	Protects the fan tap just before frost prevention control
<b>Outdoor fan</b>	Depends on command speed	
<b>4-way valve</b>	OFF	Depends on stop mode

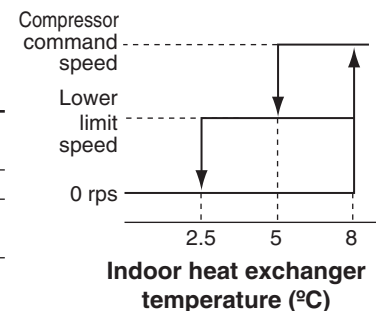

- Notes
- When the indoor heat exchanger temperature is in the range of 2.5-5°C, the speed is reduced by 4 rps at each 20 seconds.
  - When the temperature is lower than 2.5°C, the compressor is stopped.
  - When the indoor heat exchanger temperature is in the range of 5-8°C, the compressor command speed is been maintained.

**(iii) Reset conditions**

When either of the following condition is satisfied.

- The indoor heat exchanger temperature (Th2) is 8°C or higher.
- The compressor command speed is 0 rps.

**(c) Indoor fan motor protection**

When the air-conditioner is operating and the indoor fan motor is turned ON, if the indoor fan motor has operated at  $300 \text{ min}^{-1}$  or under for more than 30 seconds, the unit enters first in the stop mode and then stops the entire system.

## 1.4 Operation control function by the outdoor control

### (1) Compressor speed

Unit: rps

Item	Model	Cooling		Heating	
		FDC90	FDC100	FDC90	FDC100
Upper limit		120 (68)	120 (74)	120 (70)	120 (70)
Lower limit		12	12	12	12

Note (1) Value in ( ) are for the silent mode.

### (2) Compressor protection start

#### (a) Compressor protection start I

##### (i) Operating condition

When the compressor is turned ON from the state of OFF.

##### (ii) Detail of operation

During the protection start I control, the upper limit of compressor speed is restricted to the speeds as shown in the following table.

Unit: rps

FDC 90, 100	Cooling	TH2 ≥ 10°C	Time after establishment of operating conditions (Including acceleration time)				
			Less than 3 min	Less than 5 min	Less than 7 min	Less than 9 min	9 min or more
			120	120	120	120	End of control
FDC 90, 100	Heating <sup>(1)</sup>	TH2 ≥ 10°C	55	55	75	95	End of control
		TH2 < 10°C	55	55	75	95	

Note (1) Judgment by the outdoor air temperature sensor (TH2) is made only at the start of control during heating operation.

#### (b) Compressor protection start II

##### (i) Operating condition

When the outdoor air temperature sensor (TH2) has detected lower than 10°C after starting the compressor during heating operation.

##### (ii) Detail of operation

During the protection start II control, the upper limit of compressor speed is restricted to the speeds as shown in the following table.

Unit: rps

FDC 90, 100	Tho-A ≥ -5°C	Time after compressor ON (Including acceleration time)				
		Less than 1 min	Less than 5 min	Less than 7 min	Less than 9 min	9 min or more
	Tho-A ≥ -5°C	40	45	120	120	End of control
	Tho-A < -5°C	55	55	120	120	End of control

### (3) Outdoor fan control

#### (a) Outdoor fan speed and fan motor speed

Unit: min<sup>-1</sup>

Fan speed	1st speed	2nd speed	3rd speed	4th speed	5th speed	6th speed	7th speed	8th speed
FDC90, 100	150	300	500	650	740	835	890	950

#### (b) Outdoor fan control at start (Cooling operation only)

When the outdoor air temperature (TH2) is lower than 22°C at the start of compressor, the outdoor fan is operated at a fixed speed.

- (i) When the outdoor air temperature is higher than 11°C, the compressor runs at 2nd speed for 30 seconds after the compressor ON.
- (ii) When the outdoor air temperature is lower than 11°C, the compressor runs at 1st speed for 30 seconds after the compressor ON.



**(c) Relationship between compressor speed and outdoor fan speed.**

Outdoor fan speed is controlled according to the operation mode (Heating/cooling) and the compressor speed.

Unit: rps

Fan speed		1st speed	2nd speed	3rd speed	4th speed	5th speed	6th speed	7th speed	8th speed
FDC 90, 100	Cooling	–	–	0-30	30-46	46-64	64-70	70-75	75-
	Heating	–	–	0-30	30-46	46-70	70-90	90-	–

**(d) Outdoor fan control at low outdoor temperature**

**(i) Cooling**

**1) Operating conditions**

When the outdoor air temperature (TH2) is 22°C or lower continues for 30 seconds while the compressor speed is other than 0 rps.

**2) Detail of operation**

After the outdoor fan operates at A speed for 60 seconds; the corresponding outdoor heat exchanger temperature shall implement the following controls.

- Value of A

	Outdoor fan
15°C < Outdoor air temperature	15th speed
10°C < Outdoor air temperature ≤ 15°C	12th speed
Outdoor air temperature ≤ 10°C	10th speed

- Outdoor heat exchanger temperature ≤ 21°C  
After the outdoor fan speed drops (down) to 1 speed for 60 seconds; if the outdoor heat exchanger temperature is lower than 21°C, gradually reduce the outdoor fan speed by 1 speed. (Lower limit 9th speed)
- 21°C < Outdoor heat exchanger temperature ≤ 38°C  
After the outdoor fan speed maintains for 20 seconds; if the outdoor heat exchanger temperature is 21°C-38°C, maintain outdoor fan speed again.
- Outdoor heat exchanger temperature > 38°C  
After the outdoor fan speed rises (up) to 1 speed for 60 seconds; if the outdoor heat exchanger temperature is higher than 38°C, gradually increase outdoor fan speed by 1 speed. (Upper limit 15th speed)

**3) Reset conditions**

When either of the following conditions is satisfied.

- The outdoor air temperature (TH2) is 25°C or higher and fan speed is 15th speed.
  - The compressor speed is 0 rps.
- 4) Outdoor fan speed and fan motor speed

Unit: min<sup>-1</sup>

Fan speed	9th speed	10th speed	11th speed	12th speed	13th speed	14th speed	15th speed
FDC90, 100	200	225	250	275	300	400	500

**(ii) Heating**

**1) Operating condition**

When the outdoor air temperature (TH2) is 4°C or lower continues for 30 seconds while the compressor speed is other than 0 rps.

**2) Detail of operation**

The outdoor fan is stepped up by 2 speed step at each 20 seconds. (Upper limit 8th speed)

**3) Reset conditions**

When either of the following conditions is satisfied.

- The outdoor air temperature (TH2) is 6°C or higher.
- The compressor speed is 0 rps.

**(e) Outdoor fan control at overload**

**(i) Cooling**

**1) Operating condition**

When the outdoor air temperature (TH2) is 41°C or higher continues for 30 seconds while the compressor command speed is other than 0 rps.

**2) Detail of operation**

The outdoor fan is stepped up by 3 speed. (Upper limit 8th speed)

**3) Reset conditions**

When either of the following conditions is satisfied.

- The outdoor air temperature (TH2) is 40°C or lower.
- The compressor speed is 0 rps.

(ii) **Heating**

1) **Operating conditions**

When the outdoor air temperature (TH2) is 13°C or higher continues for 30 seconds while the compressor speed is other than 0 rps.

2) **Detail of operation**

After the outdoor fan operates at -3 speed for 60 seconds; the corresponding outdoor heat exchanger temperature shall implement the following controls.

a) Outdoor heat exchanger temperature  $\leq 10^\circ\text{C}$

After the outdoor fan speed rises (up) to 1 speed for 60 seconds; if the outdoor heat exchanger temperature is lower than 10°C, gradually increase the outdoor fan speed by 1 speed.

b)  $10^\circ\text{C} < \text{Outdoor heat exchanger temperature} \leq 13^\circ\text{C}$

After the outdoor fan speed maintains for 20 seconds; if the outdoor heat exchanger temperature is 10°C–13°C, maintain outdoor fan speed again.

c) Outdoor heat exchanger temperature  $> 13^\circ\text{C}$

After the outdoor fan speed drops (down) to 1 speed for 60 seconds; if the outdoor heat exchanger temperature is higher than 38°C, gradually reduce outdoor fan speed by 1 speed. (Lower limit 2nd speed)

3) **Reset conditions**

When either of the following conditions is satisfied.

a) The outdoor air temperature (TH2) is 11°C or lower.

b) The compressor speed is 0 rps.

(f) **Outdoor fan motor protection**

If the outdoor fan motor has operated at 75 min<sup>-1</sup> or lower for more than 30 seconds, the compressor and fan motor are stopped.

(4) **Defrost operation**

(a) Starting conditions (Defrost operation can be started only when all of the following conditions are satisfied.)

(i) After start of heating operation.

When it elapsed 35 minutes. (Accumulated compressor operation time)

(ii) After end of defrost operation.

When it elapsed 35 minutes. (Accumulated compressor operation time)

(iii) Outdoor heat exchanger sensor (TH1) temperature.

When the temperature has been below -5°C for 3 minutes continuously.

(iv) The difference between the outdoor air sensor temperature and the outdoor heat exchanger sensor temperature (TH2-TH1)

- The outdoor air temperature  $\geq -2^\circ\text{C} : 7^\circ\text{C}$  or higher
- $-15^\circ\text{C} < \text{The outdoor air temperature} < -2^\circ\text{C} : 4/15 \times \text{The outdoor air temperature} + 7^\circ\text{C}$  or higher
- The outdoor air temperature  $\leq -15^\circ\text{C} : -5^\circ\text{C}$  or higher

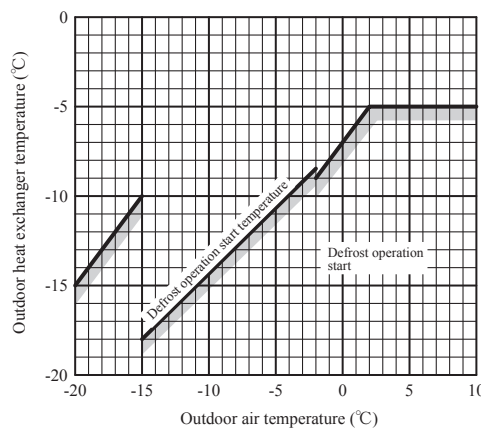

(v) During continuous compressor operation.

In addition, when the speed command from the indoor control of the indoor unit during heating operation has counted 0 rps 10 times or more and all conditions of (i), (ii) above and the outdoor air temperature is 3°C or less and the temperature for outdoor heat exchanger sensor (TH1) is -5°C or less: 62 rps or more, -4°C or less: less than 62 rps are satisfied, defrost operation is started.

- (b) Ending conditions (Operation returns to the heating cycle when either one of the following is satisfied.)
  - (i) Outdoor heat exchanger sensor (TH1) temperature: 10°C or higher.
  - (ii) Continued operation time of defrost operation → For more than 15 minutes.

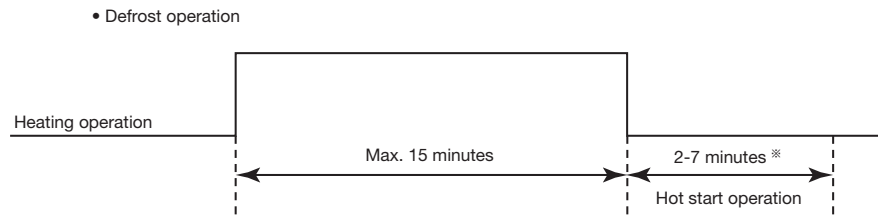

※Depends on an operation condition, the time can be longer than 7 minutes.

**(5) Cooling overload protective control**

**(a) Operating conditions**

When the outdoor air temperature (TH2) is 41°C or higher continues for 30 seconds than 0 rps.while the compressor speed is other than 0 rps.

**(b) Detail of operation**

- (i) Taking the upper limit of compressor speed range at 85(60)rps, if the output speed obtained with the fuzzy calculation exceeds the upper limit, the upper limit value is maintained.
- (ii) The lower limit of compressor speed is set to 30(40)rps and even if the calculated result becomes lower than that after fuzzy calculation, the speed is kept to 30(40)rps. However, when the thermostat OFF, the speed is reduced to 0 prs.

Note (1) Values in ( ) are for outdoor air temperature at 47°C.

**(c) Reset conditions**

The outdoor air temperature (TH2) is lower than 40°C.

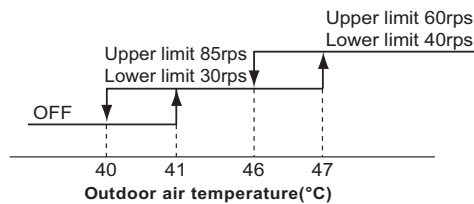

**(6) Cooling high pressure control**

**(a) Purpose**

Prevents anomalous high pressure operation during cooling.

**(b) Detector**

Outdoor heat exchanger sensor (TH1)

**(c) Detail of operation:**

**(Example) Fuzzy**

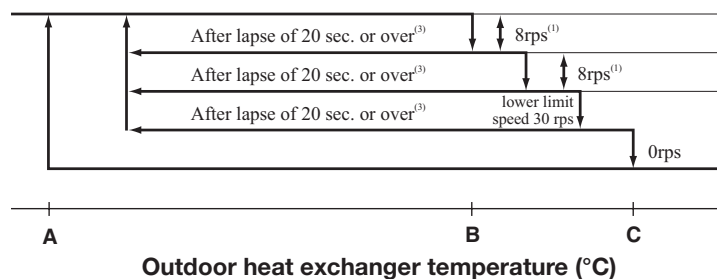

Outdoor air temperature(TH2)	Time after compressor ON	A	B	C
TH2 ≥ 32°C	Less than 10 min	50	58	60
	Less than 15 min	50	58	
	Less than 20 min	50	58	
	Less than 25 min	50	58	
	25 min or more	50	58	
TH2 < 32°C	—	51	53	56

- Notes (1) When the outdoor heat exchanger temperature is in the range of B-C°C, the compressor speed is reduced by 8 rps at each 20 seconds.  
 (2) When the temperature is C °C or higher, the compressor is stopped.  
 (3) When the outdoor heat exchanger temperature is in the range of A-B°C, if the compressor speed is been maintained and the operation has continued for more than 20 seconds at the same speed, it returns to the normal cooling operation.

**(7) Cooling low outdoor temperature protective control**

**(a) Operating conditions**

When the outdoor air temperature (TH2) is C°C or lower continues for 20 seconds while the compressor speed is other than 0 rps.

**(b) Detail of operation**

- (i) The lower limit of the compressor speed is set to 45 (35) <20> rps and even if the speed becomes lower than 45 (35) <20> rps, the speed is kept to 45 (35) <20> rps. However, when the thermostat OFF, the speed is reduced to 0 rps.
- (ii) The upper limit of the compressor speed is set to 75 <120> rps and even if the calculated result becomes higher than that after fuzzy calculation, the speed is kept to 75 <120> rps.

- Notes (1) Values in ( ) are for outdoor air temperature is C or D.  
 (2) Values in < > are for outdoor air temperature is E or F.

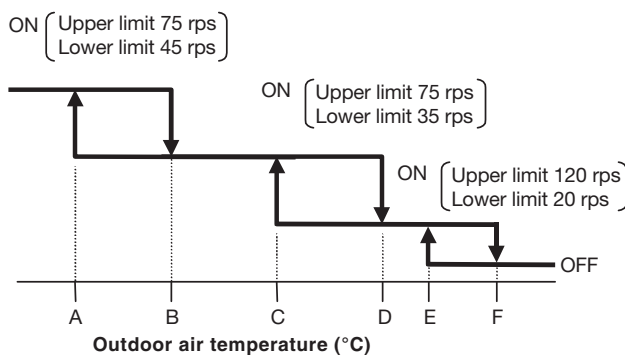

• Values of A, B, C, D, E, F  
 Model FDC90, 100VNP-W

	Outdoor air temperature (°C)					
	A	B	C	D	E	F
First time	9	11	22	25	26	28

**(iii) Reset conditions**

When either of the following condition is satisfied.

- 1) The outdoor air temperature (TH2) is F °C or higher.
- 2) The compressor speed is 0 rps.

**(8) Heating high pressure control**

**(a) Starting condition**

When the indoor heat exchanger temperature (Thi-R1, R2) has risen to a specified temperature while the compressor is turned on.

- (b) Compressor speed is controlled according to the zones of indoor heat exchanger temperature as shown by the following table.

	Thi-R < P1	P1 ≦ Thi-R < P2	P2 ≦ Thi-R < P3	P3 ≦ Thi-R
Protection control speed (NP)	Normal	Retention	NP-4rps	NP-8rps
Sampling time (s)	Normal	10	10	10

Model FDC90, 100VNP-W Unit: °C

NP	Thi-R	P1	P2	P3
10 ≦ NP < 90		45	52	57
90 ≦ NP < 120		45 - 43	52 - 45	57 - 48
120 ≦ NP		43	45	48

**(9) Heating overload protective control**

**(a) Operating conditions**

When the outdoor air temperature (TH2) is 13°C or higher continues for 30 seconds than 0 rps.while the compressor speed is other than 0 rps.

**(b) Detail of operation**

- (i) Taking the upper limit of compressor speed range at 90(75)rps, if the output speed obtained with the fuzzy calculation exceeds the upper limit, the upper limit value is maintained.
- (ii) The lower limit of compressor speed is set to 30(40)rps and even if the calculated result becomes lower than that after fuzzy calculation, the speed is kept to 30(40)rps. However, when the thermostat OFF, the speed is reduced to 0 rps.

Note (1) Values in ( ) are for outdoor air temperature at 17°C.

**(c) Reset conditions**

The outdoor air temperature (TH2) is lower than 11°C.

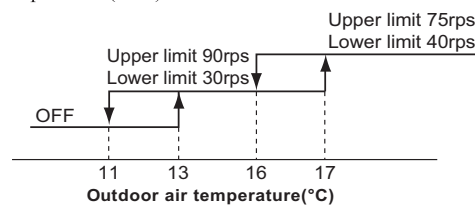

**(10) Heating low outdoor temperature protective control**

**(a) Operating conditions**

When the outdoor air temperature (TH2) is 4°C or lower continues for 30 seconds while the compressor speed is other than 0 rps.

**(b) Detail of operation**

The lower limit compressor speed is change as shown in the figure below.

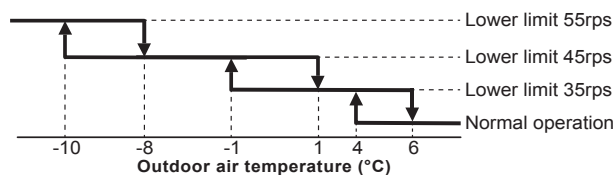

**(c) Reset conditions**

When either of the following condition is satisfied.

- (i) The outdoor air temperature (TH2) is higher than 6°C.
- (ii) The compressor speed is 0 rps.
- (iii) Compressor protection start II is activate.

**(11) Compressor overheat protection**

**(a) Purpose**

It is designed to prevent deterioration of oil, burnout of motor coil and other trouble resulting from the compressor overheat.

**(b) Detail of operation**

- (i) Speeds are controlled with temperature detected by the sensor mounted on the discharge pipe.

(Example) Fuzzy

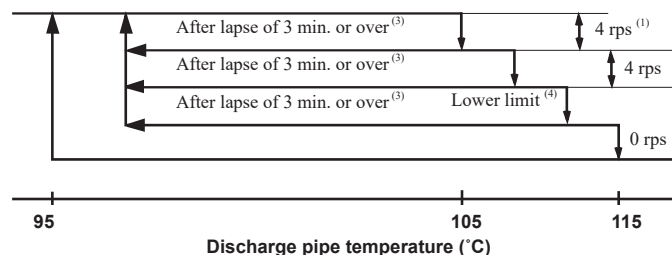

- Notes (1) When the discharge pipe temperature is in the range of 105-115°C, the speed is reduced by 4 rps.
- (2) When the discharge pipe temperature is raised and continues operation for 20 seconds without changing, then the speed is reduced again by 4 rps.
- (3) If the discharge pipe temperature is in the range of 95-105°C even when the compressor speed is maintained for 3 minutes when the temperature is in the range of 95-105°C, the speed is raised by 1 rps and kept at that speed for 3 minutes. This process is repeated until the command speed is reached.
- (4) Lower limit speed

	Cooling	Heating
<b>Lower limit speed</b>	25 rps	32 rps

- (ii) If the temperature of 115°C is detected by the sensor on the discharge pipe, then the compressor will stop immediately. When the discharge pipe temperature drops and the time delay of 3 minutes is over, the unit starts again within 1 hour but there is no start at the third time.

**(12) Current safe**

**(a) Purpose**

Current is controlled not to exceed the upper limit of the setting operation current.

**(b) Detail of operation**

- (i) Input current to the converter is monitored with the current sensor fixed on the printed circuit board of the outdoor unit and, if the operation current value reaches the limiting current value, the compressor speed is reduced.
- (ii) If the mechanism is actuated when the compressor speed is less than 30 rps, the compressor is stopped immediately. Operation starts again after a delay time of 3 minutes.

**(13) Current cut**

**(a) Purpose**

Inverter is protected from overcurrent.

**(b) Detail of operation**

Output current from the inverter is monitored with a shunt resistor and, if the current exceeds the setting value, the compressor is stopped immediately. Operation starts again after a delay time of 3 minutes.

**(14) Outdoor unit failure**

This is a function for determining when there is trouble with the outdoor unit during air-conditioning.

The compressor is stopped if any one of the following in item (a), (b) is satisfied. Once the unit is stopped by this function, it is not restarted.

- (a) When the input current is measured at 1 A or less for 3 continuous minutes or more.
- (b) If the outdoor unit sends a 0 rps signal to the indoor unit 3 times or more within 20 minutes of the power being turned on.

**(15) Serial signal transmission error protection**

**(a) Purpose**

Prevents malfunction resulting from error on the indoor ↔ outdoor signals.

**(b) Detail of operation**

- (i) If the compressor is operating and a serial signal cannot be received from the indoor control with outdoor control having serial signals continues for 7 minutes and 35 seconds, the compressor is stopped.
- (ii) After the compressor has been stopped, it will be restarted after the compressor start delay if a serial signal can be received again from the indoor control.

**(16) Rotor lock**

If the motor for the compressor does not turn after it has been started, it is determined that a compressor lock has occurred and the compressor is stopped.

**(17) Refrigeration cycle system protection**

**(a) Starting conditions**

- (i) When 5 (Heating: 9) minutes have elapsed after the compressor ON or the completion of the defrost control.
- (ii) Other than the defrost control.
- (iii) When, after satisfying the conditions of (i) and (ii) above, the compressor speed, indoor air temperature (Thi-A) and indoor heat exchanger temperature (Thi-R) have satisfied the conditions in the following table for 5 minutes:

Operation mode	Compressor speed (N)	Indoor air temperature (Thi-A)	Indoor air temperature (Thi-A)/ Indoor heat exchanger temperature (Thi-R)
Cooling	$40 \leq N$	$10 \leq \text{Thi-A} \leq 40$	$\text{Thi-A} - 4 < \text{Thi-R}$
Heating	$40 \leq N$ : Outdoor air temperature $\geq 0^\circ\text{C}$ $60 \leq N$ : Outdoor air temperature $< 0^\circ\text{C}$	$0 \leq \text{Thi-A} \leq 40$	$\text{Thi-R} < \text{Thi-A} + 6$

**(b) Contents of control**

- (i) When the conditions of (a) above are satisfied, the compressor stops.
- (ii) Error stop occurs when the compressor has stopped 3 times within 60 minutes.

**(c) Reset condition**

When the compressor has been turned OFF

**(18) Silent mode**

As “Silent mode start” signal is received from the remote control, it operates by dropping the outdoor fan tap.

Model	Item	Outdoor fan tap (Upper limit)
FDC90, 100VNP-W		Cooling: 7th speed, Heating: 7th speed

**(19) Broken wire detection on temperature sensor**

- (a) Outdoor unit heat exchanger temperature sensor, outdoor air temperature sensor.

If the following is detected for 5 seconds continuously within 2 minutes to 2 minutes and 20 seconds after the compressor ON, the compressor stops. After a delay of 3 minutes, it restarts but, if the same is detected repeatedly 3 times within 40 minutes, the compressor stops with the anomalous stop. Or with in 20 seconds after power ON.

Note (1) During defrost operation and for 3 minutes after the end of defrost operation, it is not detected.

- Outdoor unit heat exchanger temperature sensor:  $-55^{\circ}\text{C}$  or lower.
- Outdoor air temperature sensor:  $-55^{\circ}\text{C}$  or lower.

- (b) Discharge pipe temperature sensor.

If the following is detected for 5 seconds continuously within 10 minutes to 10 minutes and 20 seconds after the compressor ON, the compressor stops. After a delay of 3 minutes, it restarts but, if the same is detected repeatedly 3 times within 40 minutes, the compressor stops with the anomalous stop.

Note (1) During defrost operation and for 3 minutes after the end of defrost operation, it is not detected.

- Discharge pipe temperature sensor:  $-25^{\circ}\text{C}$  or lower.

## 2. MAINTENANCE DATA

### 2.1 FDT, FDU, FDUM, FDE series

#### 2.1.1 Diagnosing of microcomputer circuit

##### (1) Selfdiagnosis function

##### (a) Check indicator table

Whether a failure exists or not on the indoor unit can be know by the contents of remote control error code, indoor unit green LED (power pilot lamp and microcomputer normality pilot lamp) or red LED (check pilot lamp).

##### (i) Indoor unit

Remote control		Indoor unit control PCB		Location of trouble	Description of trouble	Repair method	Reference page
Error code	Red LED	Red LED	Green LED (fl)				
No-indication	Stays OFF	Stays OFF	Keeps flashing	—	• Normal operation	—	—
		Stays OFF	Stays OFF	Indoor unit power source	• Power OFF, broken wire/blown fuse, broken transformer wire	Repair	73
		* 3-time flash	Keeps flashing	Remote control wires	• Poor connection, breakage of remote control wire * For wire breaking at power ON, the LED is OFF.	Repair	74
		Remote control	• Defective remote control PCB	Replacement of remote control			
WAIT or INSPECT I/U		Stays OFF	Keeps flashing	Indoor-outdoor units connection wire	• Poor connection, breakage of indoor-outdoor units connection wire	Repair	75-79
				Remote control	• Improper setting of master and slave by remote control		
E1	Stays OFF	* Keeps flashing	Remote control wires (Noise)	• Poor connection of remote control signal wire (White) * For wire breaking at power ON, the LED is OFF	Repair	Replacement of remote control or PCB	80
			Remote control indoor unit control PCB	* Defective remote control or indoor unit control PCB (defective communication circuit)?			
E5	2-time flash	Keeps flashing	Indoor-outdoor units connection wire	• Poor connection of wire between indoor-outdoor units during operation (disconnection, loose connection) • Anomalous communication between indoor-outdoor units by noise, etc.	Repair	Replacement of PCB	81
	2-time flash	Keeps flashing	(Noise)	• CPU-runaway on outdoor PCB	Power reset or Repair		
	2-time flash	Keeps flashing	Outdoor unit PCB	* Occurrence of defective outdoor unit PCB on the way of power source (defective communication circuit)?	Replacement of PCB		
			Outdoor unit PCB	• Defective outdoor unit PCB on the way of power source	Replacement		
E6	1-time flash	Keeps flashing	Indoor heat exchanger temperature sensor	• Defective indoor heat exchanger temperature sensor (defective element, broken wire, short-circuit) • Poor contact of temperature sensor connector	Replacement, repair of temperature thermistor	Replacement of PCB	82
			Indoor unit control PCB	* Defective indoor unit control PCB (Defective temperature sensor input circuit)?			
E7	1-time flash	Keeps flashing	Indoor return air temperature sensor	• Defective indoor return air temperature sensor (defective element, broken wire, short-circuit) • Poor contact of temperature sensor connector	Replacement, repair of temperature thermistor	Replacement of PCB	83
			Indoor unit control PCB	* Defective indoor unit control PCB (Defective temperature sensor input circuit)?			
E8	1-time flash	Keeps flashing	Installation or operating condition	• Heating over-load (Anomalous high indoor heat exchanger temperature)	Repair	Replacement of temperature thermistor	84
			Indoor heat exchanger temperature sensor	• Defective indoor heat exchanger temperature sensor (short-circuit)	Replacement of temperature thermistor		
			Indoor unit control PCB	* Defective indoor unit control PCB (Defective temperature sensor input circuit)?	Replacement of PCB		
E9	1-time flash	Keeps flashing	Drain trouble	• Defective drain pump (DM), broken drain pump wire, disconnected connector	Replacement, repair of DM	Replacement of PCB	85
			Float switch	• Anomalous float switch operation (malfunction)	Repair		
			Indoor unit control PCB	* Defective indoor unit control PCB (Defective float switch input circuit)	Replacement of PCB		
				* Defective indoor unit control PCB (Defective DM drive output circuit)?			
E10	Stays OFF	Keeps flashing	Number of connected indoor units	• When multi-unit control by remote control is performed, the number of units is over	Repair	86	
			E11	Keeps flashing	Keeps flashing	Address setting error	• Address setting error of indoor units
E14	3-time flash	Keeps flashing	Indoor unit No. setting	• No master is assigned to slaves.	Repair	88	
			Remote control wires	• Anomalous remote control wire connection, broken wire between master and slave units			
E16	1(2)-time flash	Keeps flashing	Fan motor	• Defective fan motor	Replacement, repair	89	
			Indoor unit power PCB	• Defective indoor unit power PCB	Replacement		
E18	1-time flash	Keeps flashing	Address setting error	• Address setting error of master and slave indoor units	Repair	90	
E19	1-time flash	Keeps flashing	Indoor unit control PCB	• Improper operation mode setting	Repair	91	



Remote control		Indoor unit control PCB		Location of trouble	Description of trouble	Repair method	Reference page
Error code	Red LED	Red LED	Green LED (1)				
E20	Keeps flashing	1(2)-time flash	Keeps flashing	Fan motor	• Defective by rotation speed of fan motor	Replacement, repair	92
				Indoor unit power PCB	• Defective indoor unit power PCB	Replacement	
E28		Stays OFF	Keeps flashing	Remote control temperature sensor	• Broken wire of remote control temperature sensor	Repair	93

Notes (1) **Normal indicator lamp (Indoor unit: Green) extinguishes (or lights continuously) only when CPU is anomalous. It keeps flashing in any trouble other than anomalous CPU.**

(2) \* mark in the description of trouble means that, in ordinary diagnosis, it cannot identify the cause definitely, and, if the trouble is repaired by replacing the part, it is judged consequently that the replaced part was defective.

### (ii) Outdoor unit

Remote control		Indoor unit control PCB		Location of trouble	Description of trouble	Repair method	Reference page
Error code	Red LED	Red LED	Green LED				
E35		Stays OFF	Keeps flashing	Installation, operation status	• Higher outdoor heat exchanger temperature	Repair	94
				Outdoor heat exchanger temperature sensor	• Defective outdoor heat exchanger temperature sensor	Replacement, repair of temperature sensor	
				Outdoor unit PCB	* Defective outdoor unit PCB (Defective temperature sensor input circuit)?	Replacement of PCB	
E36		Stays OFF	Keeps flashing	Installation, operation status	• Higher discharge temperature	Repair	95
				Discharge pipe temperature sensor	• Defective discharge pipe temperature sensor	Replacement, repair of temperature sensor	
				Outdoor unit PCB	* Defective outdoor unit PCB (Defective temperature sensor input circuit)?	Replacement of PCB	
E37		Stays OFF	Keeps flashing	Outdoor heat exchanger temperature sensor	• Defective outdoor heat exchanger temperature sensor, broken wire or poor connector connection	Replacement, repair of temperature sensor	96
				Outdoor unit PCB	* Defective outdoor unit PCB (Defective temperature sensor input circuit)?	Replacement of PCB	
E38		Stays OFF	Keeps flashing	Outdoor air temperature sensor	• Defective outdoor air temperature sensor, broken wire or poor connector connection	Replacement, repair of temperature sensor	97
				Outdoor unit PCB	* Defective outdoor unit PCB (Defective temperature sensor input circuit)?	Replacement of PCB	
E39	Keeps flashing	Stays OFF	Keeps flashing	Discharge pipe temperature sensor	• Defective discharge pipe temperature sensor, broken wire or poor connector connection	Replacement, repair of temperature sensor	98
				Outdoor unit PCB	* Defective outdoor unit PCB (Defective temperature sensor input circuit)?	Replacement of PCB	
E40		Stays OFF	Keeps flashing	Installation, operation status	• Service valve (gas side) closing operation	Replacement	99
E42		Stays OFF	Keeps flashing	Outdoor unit PCB, compressor	• Current cut (Anomalous compressor over-current)	Replacement of PCB	100 • 101
				Installation, operation status	• Service valve closing operation	Repair	
E47		Stays OFF	Keeps flashing	Outdoor unit PCB	• Over voltage	Repair PCB replacement	102
					• Defective active filter		
E48		Stays OFF	Keeps flashing	Fan motor	• Defective fan motor	Replacement	103
				Outdoor unit PCB	• Defective outdoor unit PCB		
E51		Stays OFF	Keeps flashing	Power transistor error (Outdoor unit PCB)	• Power transistor error	Replacement of PCB	104
E57		Stays OFF	Keeps flashing	Operation status	• Shortage in refrigerant quantity	Repair	105
				Installation status	• Service valve closing operation	Service valve opening check	
E58		Stays OFF	Keeps flashing	• Overload operation • Overcharge • Compressor locking	• Current safe stop	Replacement	106
E59		Stays OFF	Keeps flashing	Compressor, outdoor unit PCB	• Anomalous compressor startup • Voltage drop	Replacement	107
E60		Stays OFF	Keeps flashing	Compressor	• Anomalous compressor rotor lock	Replacement	108

Note (1) \* mark in the description of trouble means that, in ordinary diagnosis, it cannot identify the cause definitely, and, if the trouble is repaired by replacing the part, it is judged consequently that the replaced part was defective.



**(iv) Display sequence of error codes or inspection indicator lamps****■ Occurrence of one kind of error**

Displays are shown respectively according to errors.

**■ Occurrence of plural kinds of error**

Section	Category of display
<b>Error code on remote control</b>	<ul style="list-style-type: none"> <li>Displays the error of higher priority (When plural errors are persisting)</li> </ul>
<b>Red LED on indoor unit control PCB</b>	<p style="text-align: center;"><i>E1 E5</i> ..... <i>E10</i> &gt; <i>E35</i> &gt; ..... <i>E60</i></p> <ul style="list-style-type: none"> <li>Displays the present errors. (When a new error has occurred after the former error was reset.)</li> </ul>

**■ Error detecting timing**

Section	Error description	Error code	Error detecting timing
Indoor	Drain trouble (Float switch activated)	<i>E9</i>	Whenever float switch is activated after 30 seconds had past since power ON.
	Communication error at initial operation	“  WAIT  ”	No communication between indoor and outdoor units is established at initial operation.
	Remote control communication circuit error	<i>E1</i>	Communication between indoor unit and remote control is interrupted for more than 2 minutes continuously after initial communication was established.
	Communication error during operation	<i>E5</i>	Communication between indoor and outdoor units is interrupted for more than 2 minutes continuously after initial communication was established.
	Excessive number of connected indoor units by controlling with one remote control	<i>E10</i>	Whenever excessively connected indoor units is detected after power ON.
	Return air temperature sensor anomaly	<i>E7</i>	-50°C or lower is detected for 5 seconds continuously within 60 minutes after initial detection of this anomalous temperature.
	Indoor heat exchanger temperature sensor anomaly	<i>E6</i>	-50°C or lower is detected for 5 seconds continuously within 60 minutes after initial detection of this anomalous temperature. Or 70°C or higher is detected for 5 seconds continuously.
Outdoor	Outdoor air temperature sensor anomaly	<i>E38</i>	-55°C or lower is detected for 5 seconds continuously 3 times within 40 minutes after initial detection of this anomalous sensor. Or -55°C or higher is detected for 5 seconds continuously within 20 seconds after power ON.
	Outdoor heat exchanger temperature sensor anomaly	<i>E37</i>	-55°C or lower is detected for 5 seconds continuously 3 times within 40 minutes after initial detection of this anomalous sensor. Or -55°C or lower is detected for 5 seconds continuously within 20 seconds after power ON.
	Discharge pipe temperature sensor anomaly	<i>E39</i>	-25°C or lower is detected for 5 seconds continuously 3 times within 40 minutes after initial detection of this anomalous sensor.

■ **Error log and reset**

Error indicator	Memorized error log	Reset
Remote control display	• Higher priority error is memorized.	<ul style="list-style-type: none"> <li>• Stop the unit by pressing the ON/OFF switch of remote control.</li> <li>• If the unit has recovered from anomaly, it can be operated.</li> </ul>
Red LED on indoor unit control PCB	• Not memorized.	
—	• Memorizes a mode of higher priority.	

■ **Resetting the error log**

- Resetting the memorized error log in the remote control  
Holding down “CHECK” button, press “TIMER” button to reset the error log memorized in the remote control.
- Resetting the memorized error log in the indoor unit  
The remote control transmits error log erase command to the indoor unit when “VENTI” button is pressed while holding down “CHECK” button.  
Receiving the command, the indoor unit erase the log and answer the status of no error.

(2) **Troubleshooting procedure**

When any trouble has occurred, inspect as follows. Details of respective inspection method will be described on later pages.

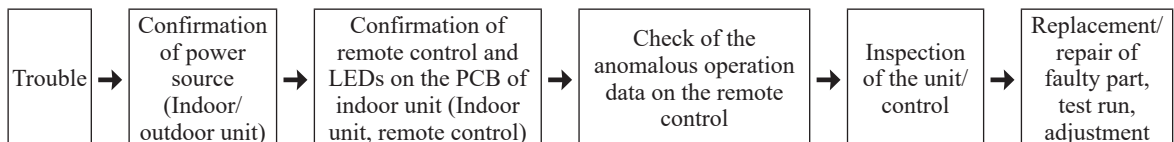

(3) **Troubleshooting at the indoor unit**

With the troubleshooting, find out any defective part by checking the voltage (AC, DC), resistance, etc. at respective connectors at around the indoor unit PCB, according to the inspection display or operation status of unit (the compressor does not run, fan does not run, the 4-way valve does not switch, etc.), and replace or repair in the unit of following part.

(a) **Replacement part related to indoor unit PCB's**

Control PCB, power source PCB, temperature sensor (return air, indoor heat exchanger), remote control switch and fuse

Note (1) With regard to parts of high voltage circuits and refrigeration cycle, judge it according to ordinary inspection methods.

(b) **Instruction of how to replace indoor unit control PCB**

**SAFETY PRECAUTIONS**

- Read the "SAFETY PRECAUTIONS" carefully first of all and then strictly follow it during the replacement in order to protect yourself.
- The precautionary items mentioned below are distinguished into two levels, WARNING and CAUTION. Both mentions the important items to protect your health and safety so strictly follow them by any means.
  - ⚠ **WARNING** Wrong installation would cause serious consequences such as injuries or death.
  - ⚠ **CAUTION** Wrong installation might cause serious consequences depending on circumstances.
- After completing the replacement, do commissioning to confirm there are no anomaly.

**⚠ WARNING**

- Replacement should be performed by the specialist.  
If you replace the PCB by yourself, it may lead to serious trouble such as electric shock or fire.
- Replace the PCB correctly according to these instructions.  
Improper replacement may cause electric shock or fire.
- Shut off the power before electrical wiring work.  
Replacement during the applying the current would cause the electric shock, unit failure or improper running.  
It would cause the damage of connected equipment such as fan motor, etc.
- Fasten the wiring to the terminal securely, and hold the cable securely so as not to apply unexpected stress on the terminal.  
Loose connections or hold could result in abnormal heat generation or fire.
- Check the connection of wiring to PCB correctly before turning on the power, after replacement.  
Defectiveness of replacement may cause electric shock or fire.

**⚠ CAUTION**

- In connecting connector onto the PCB, connect not to deform the PCB. It may cause breakage or malfunction.
- Insert connector securely, and hook stopper. It may cause fire or improper running.
- Bundle the cables together so as not to be pinched or be tensioned. It may cause malfunction or electric shock for disconnection or deformation.

**1) Model FDT series**

- a) Replace the control PCB
  - i) Unscrew terminal (Arrow A) of the "E1" wiring (yellow/green) that is connected to PCB.
  - ii) Replace the PCB only after all the wirings connected to the connector are removed.
  - iii) Fix the board such that it will not pinch any of the wires.
  - iv) Switch setting must be same setting as that of the removed PCB.
  - v) Reconnect the all wirings to the PCB, that was removed in ii).
  - vi) Rescrew the terminal (Arrow A) of the "E1" wiring, that was removed in i).
  
- b) Control PCB (※Parts mounting are different by the kind of PCB.)

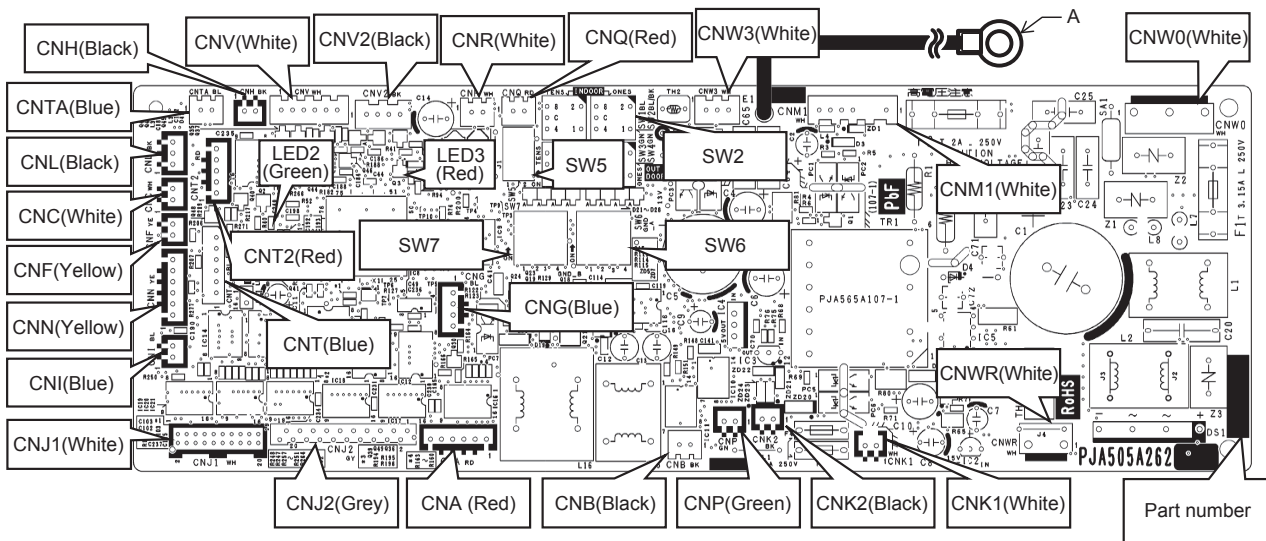

PSC012D050 

2) Models FDU, FDUM, FDE series

a) Control PCB

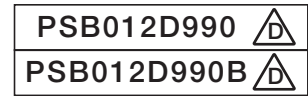

Replace and set up the PCB according to this instruction.

- i) Set to an appropriate address and function using switch on PCB.  
Select the same setting with the removed PCB.

item	switch	Content of control			
Address	SW2	Plural indoor units control by 1 remote control			
Master /Slave setting	SW5-1	—	—	○	○
	SW5-2	—	○	—	○
Test run	SW7-1	—	Normal		
		○	Operation check/drain motor test run		

○:ON —:OFF

- ii) Set to an appropriate capacity using the model selector switch(SW6).  
Select the same capacity with the PCB removed from the unit.

SW6	-1	-2	-3	-4
100VH	○	○	—	○

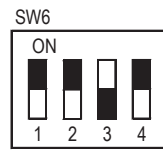

Example setting for 71VH

- iii) Replace the PCB

- ① Exchange PCB after detaching all connectors connected with the PCB.
- ② Fix the PCB so as not to pitch the wiring.
- ③ Connect connectors to the PCB. Match the wiring connector to the connector color on the PCB and connect it.

- iv) Control PCB

Parts mounting are different by the kind of PCB.

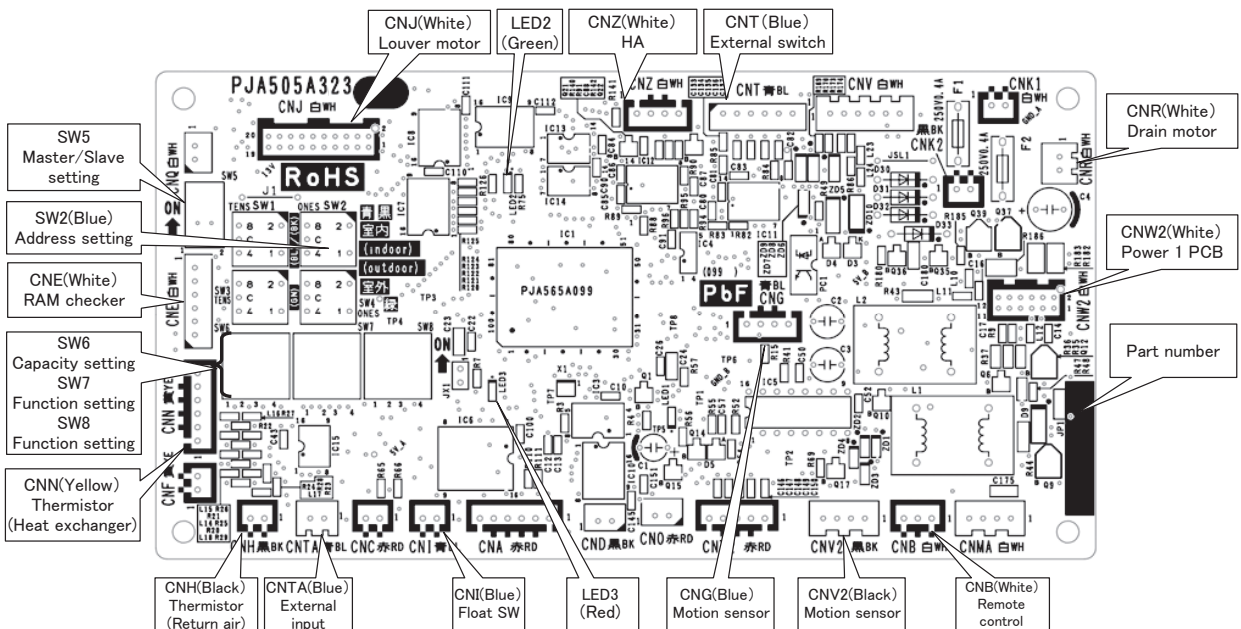

**b) Power PCB**

This PCB is a general PCB. Replace the PCB according to this instruction.

i) Replace the PCB

- ① Unscrew terminal of the wiring(yellow/green) connected to Terminal block (CNWO) from the box.
- ② Replace the PCB only after all the wirings connected to the connector are removed.
- ③ Fix the board such that it will not pinch any of the wires.
- ④ Reconnect the wirings to the PCB. Wiring connector color should match with the color of connector of the PCB.
- ⑤ Screw back the terminal of wiring, that was removed in ①.

ii) Power PCB

Parts mounting are different by the kind of PCB.

• Models FDU100VH

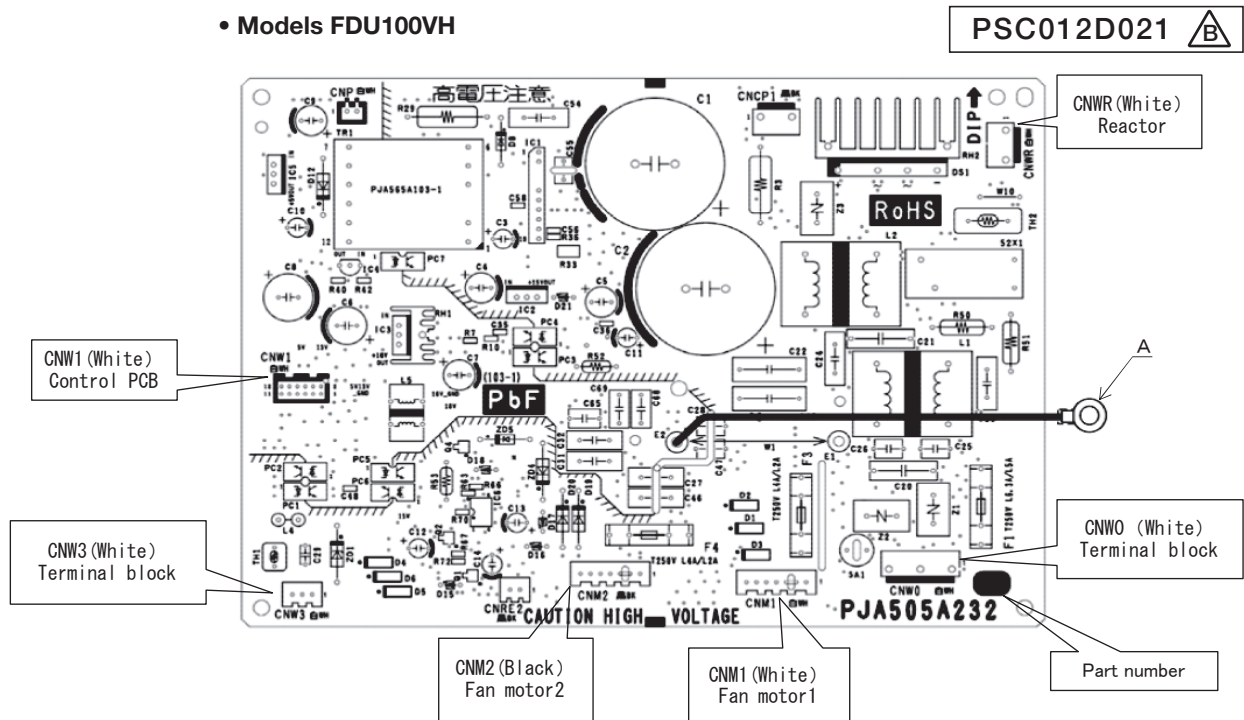

• Models FDUM100VH

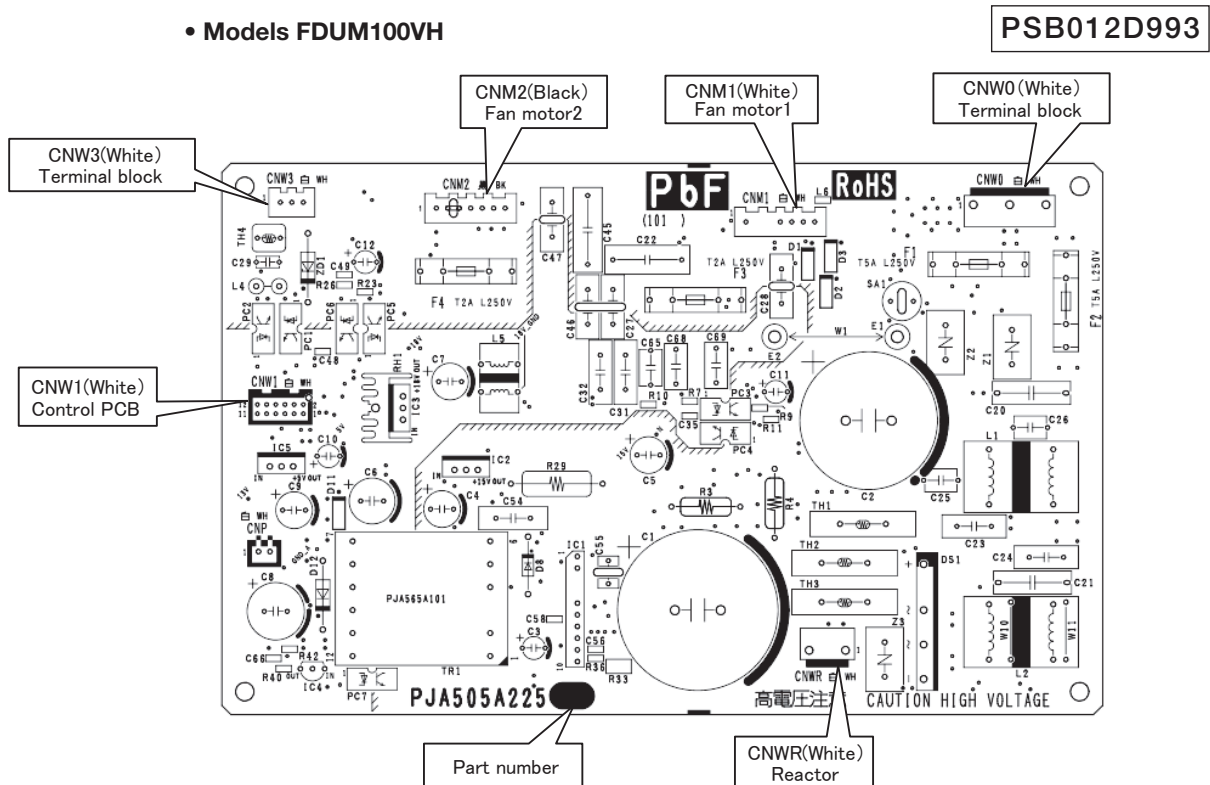

• Models FDE100VH

PSB012D992 

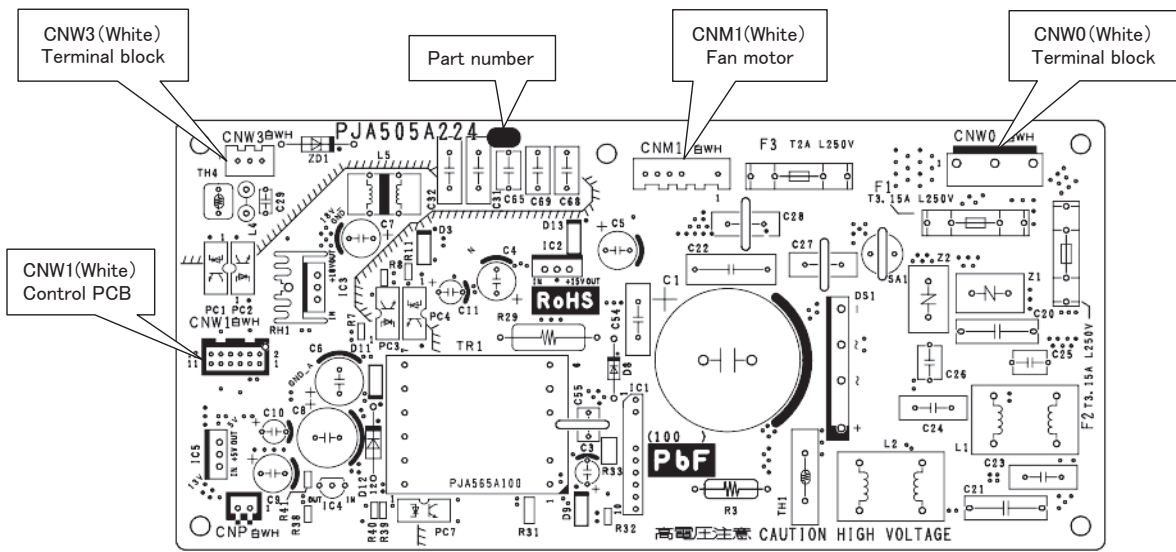

### ● DIP switch setting list

Switch	Description		Default setting		Remark
SW2	Address No. setting at plural indoor units control by 1 R/C		0		0-F
SW5-1	Reserved		OFF		keep OFF
SW5-2	Reserved		OFF		keep OFF
SW6-1	Model selection		As per model		See table 1.
SW6-2					
SW6-3					
SW6-4					
SW7-1	Test run, drain pump motor	Normal*/Test run	OFF	Normal	
SW7-2	Reserved		OFF		keep OFF
SW7-3	Powerful mode	Valid*/Invalid	ON	Valid	
SW7-4	Reserved		OFF		keep OFF
SW8-1	Anti-freeze control	Valid/Invalid*	OFF	Invalid	
SW8-2	Reserved		OFF		keep OFF
SW8-3	Reserved		OFF		keep OFF
SW8-4	Reserved		OFF		keep OFF
JSL1	Superlink terminal spare	Normal*/Switch to spare	With		

Note (1) SW8 : FDE only. \* Default setting

Table 1: Indoor unit model selection with SW6-1-SW6-4

0: OFF 1:ON

	100VH
SW6-1	1
SW6-2	1
SW6-3	0
SW6-4	1



**(4) Troubleshooting at the outdoor unit**

When troubleshooting the outdoor unit, firstly assess the overview of malfunction and try to presume the cause and the faulty part by checking the error code displayed on the remote control, and then proceed further inspection and remedy it.

Self-diagnosis system by microcomputer on indoor unit and outdoor unit PCB can assist to find the cause of malfunction smoothly by making a diagnosis of not only the anomaly of microcomputer, but also the anomaly in power source system, installation space, overload resulting from improper charging amount of refrigerant and etc.

Unless the power is reset, the error log is saved in memory and the inspection indicator lamps on outdoor unit PCB keep flashing after automatical recovering from malfunction.

After automatical recovering from malfunction, if any another error mode which has a higher priority than the previous error saved in memory occurs, it is overwritten in memory and is displayed.

**[Reset of power source]**

Be sure to avoid electrical shock, when replacing or checking the outdoor unit PCB, because some voltage is still retained in the electrolytic capacitor on the PCB even after shutting down the power source to the outdoor unit.

Be sure to start repairing work, and reconfirming that voltage has been discharged sufficiently by measuring the voltage (DC) between both terminals of electrolytic capacitor (C58) (Measurement of voltage may be disturbed by the moisture-proof coating. In such case, remove the coating and measure it by taking care of avoiding electrical shock.)

**(a) Module of part to be replaced for outdoor unit control**

Outdoor unit PCB, Temperature sensor (of outdoor heat exchanger, discharge pipe, outdoor air), Fuses (for power source and main PCB)

**(b) Replacement procedure of outdoor unit control PCB**

<b>Precautions for Safety</b>	
<ul style="list-style-type: none"> <li>• Since the following precaution is the important contents for safety, be sure to observe them. WARNING and CAUTION are described as follows:</li> </ul>	
<div style="border: 1px solid black; padding: 2px; display: inline-block;"> <b>WARNING</b></div>	Indicates an imminently hazardous situation which will result in death or serious injury if proper safety procedures and instructions are not adhered to.
<div style="border: 1px solid black; padding: 2px; display: inline-block;"> <b>CAUTION</b></div>	Indicates a potentially hazardous situation which may result in minor or moderate injury if proper safety procedures and instructions are not adhered to.
<b>WARNING</b>	
<ul style="list-style-type: none"> <li>• Securely replace the PCB according to this procedure. If the PCB is incorrectly replaced, it will cause an electric shock or fire.</li> <li>• Be sure to check that the power source for the outdoor unit is turned OFF before replacing the PCB. The PCB replacement under current-carrying will cause an electric shock or fire.</li> <li>• After finishing the PCB replacement, check that wiring is correctly connected with the PCB before power distribution. If the PCB is incorrectly replaced, it will cause an electric shock or fire.</li> </ul>	
<b>CAUTION</b>	
<ul style="list-style-type: none"> <li>• Band the wiring so as not to tense because it will cause an electric shock.</li> </ul>	

**Model FDC90, 100VNP-W**

- 1) Shut down a power source.
- 2) Remove a top panel.(Fig.1 ①)
- 3) Detach a service panel.(Fig.1 ②)
- 4) Detach a top panel of control box.

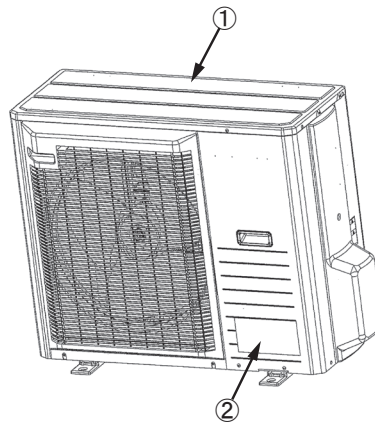

Fig.1 Outdoor unit

- 5) Make sure that 3 minutes are elapsed after shutting down a power source.
- 6) Check a voltage with the terminal of C58 by multimeter. (Fig.2)

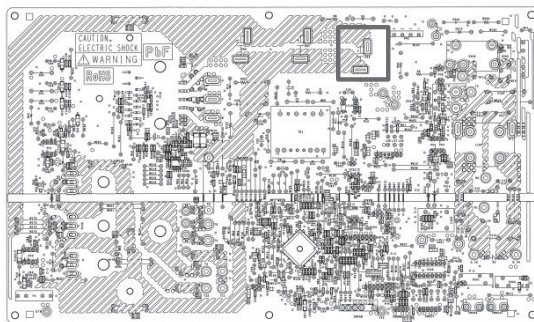

Fig.2 Terminal of C58 on PCB

- 7) Detach a cover of terminal block.(Fig.3 ④)
- 8) Detach a cover of reactor.(Fig.3 ⑤)
- 9) Remove a screw fixing a control PCB.(Fig.3 ⑥)



Fig 3. Cover of terminal block, reactor and screw of PCB

- 9) Disconnect the cable of terminal block and fuse. (Fig.4 ⑦、⑧)  
 10) Disconnect the cables of reactor. (Fig.4 ⑨)

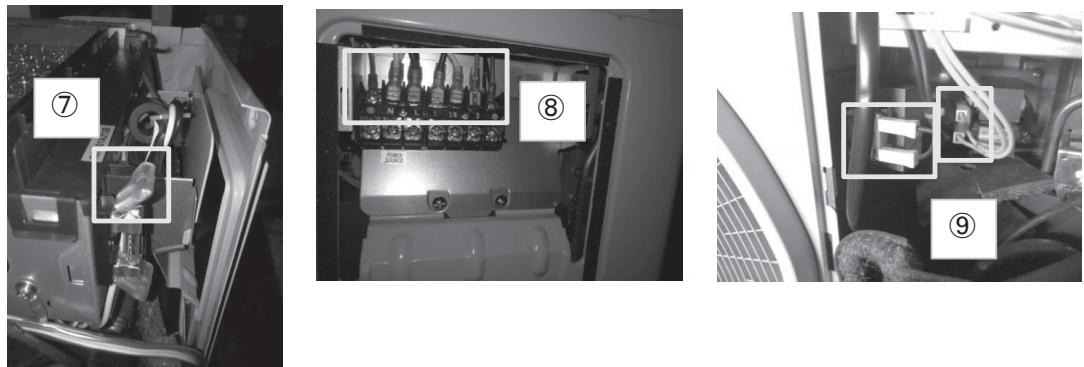

Fig.4 Cable of fuse, terminal block and reactor

- 11) Disconnect 2 earth cables on right side of control box. (Fig.5 ⑩、⑪)



Fig.5 Earth cable of control box

- 12) Disconnect CnTH(Black) on control PCB. (Fig.6 ⑫)  
 13) Disconnect a power cable of compressor(U,V,W) from control PCB. (Fig.6 ⑬)

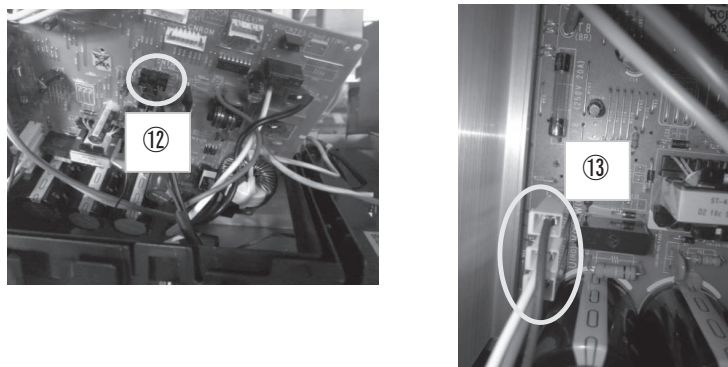

Fig.6 CnTH and power cable of compressor(U,V,W)

- 14) Take a control PCB out. (Fig.7)  
 Note: When you take a control box out, please pull it up straight.  
 Otherwise, it can be damaged.

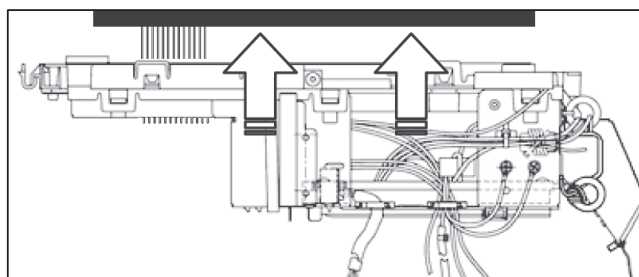

Fig.7 How to remove control PCB

15) Make sure setting of jumper on new PCB is the same with old PCB's setting. (Fig.8)

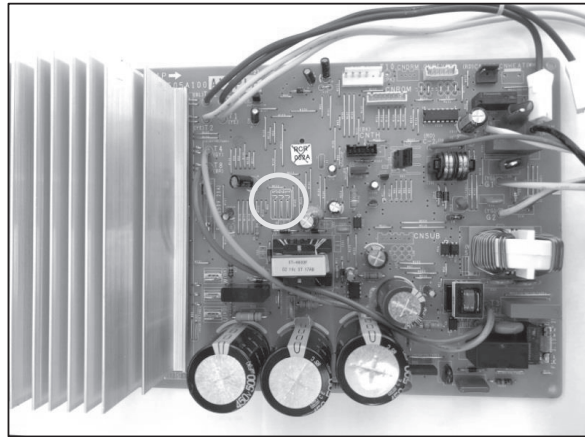

Fig.8 Setting of jumper on PCB

16) Connect the cables and connectors with the control PCB. (Confirm the **connectors are not half inserted.**)

**(5) Check of anomalous operation data with the remote control****(a) In case of RC-EX3A remote control**

[Operating procedure]

- ① On the TOP screen, touch the buttons in the order of “Menu” → “Service setting” → “Service & Maintenance” → “Service password” → “Set” → “Error display” → “Error history”.
- ② When only one indoor unit is connected to the remote control, followings will be displayed.
  1. When there is any anomaly: “Loading. Wait a while” is displayed, followed by the operation data at the occurrence of anomaly  
 〈Contents of display〉
    - Error code
    - Number and data item
  2. When there is no anomaly: “No anomaly” is displayed, and this mode is terminated.
- ③ When two or more indoor units are connected to the remote control, followings will be displayed.
  1. When there is any anomaly: If the unit having anomaly is selected on the “Select IU” screen, “Loading. Wait a while” is displayed, followed by the operation data at the occurrence of anomaly.  
 〈Contents of display〉
    - Indoor unit No.
    - Error code
    - Number and data item
  2. When there is no anomaly: “No anomaly” is displayed, and this mode is terminated.

Note (1) When the number of connected units cannot be shown in a page, select “Next”.

- ④ If you press [RUN/STOP] button, the display returns to the TOP screen.

◎ **If you touch “Back” button on the way of setting, the display returns to the last precious screen.**

Note (1) When two remote controls are used to control indoor units, the check of anomalous operation data can be made on the master remote control only. (It cannot be operated from the slave remote control.)

■ Anomalous operation data (Corresponding data may not be provided depending on models. Such items will not be displayed.)

Number	Data Item
01	☼ (Operation Mode)
02	SET TEMP (Set Temperature)
03	RETURN AIR (Return Air Temperature)
04	SENSOR (Remote Control Temperature Sensor Temperature)
05	THC-R1 (Indoor Heat Exchanger Temperature Sensor / U Bend)
06	THC-R2 (Indoor Heat Exchanger Temperature Sensor / Capillary)
07	THC-R3 (Indoor Heat Exchanger Temperature Sensor / Gas Header)
08	I/U FANSPEED (Indoor Unit Fan Speed)
09	DEMAND Hz (Frequency Requirements)
10	ANSWER Hz (Response Frequency)
11	I/U EEV P (Pulse of Indoor Unit Expansion Valve)
12	TOTAL I/U RUN H (Total Running Hours of The Indoor Unit)
13	SUPPLY AIR (Supply Air Temperature)
21	OUTDOOR (Outdoor Air Temperature)
22	THO-R1 (Outdoor Heat Exchanger Temperature Sensor)
23	THO-R2 (Outdoor Heat Exchanger Temperature Sensor)
24	COMP Hz (Compressor Frequency)
25	HP MPa (High Pressure)
26	P MPa (Low Pressure)
27	Td (Discharge Pipe Temperature)
28	COMP BOTTOM (Comp Bottom Temperature)
29	CT AMP (Current)
30	TARGET SH (Target Super Heat)
31	SH (Super Heat)
32	TDSH (Discharge Pipe Super Heat)
33	PROTECTION No. (Protection State No. of The Compressor)
34	O/U FANSPEED (Outdoor Unit Fan Speed)
35	63H1 (63H1 On/Off)
36	DEFROST (Defrost Control On/Off)
37	TOTAL COMP RUN H (Total Running Hours of The Compressor)
38	O/U EEV1 P (Pulse of The Outdoor Unit Expansion Valve EEV1)
39	O/U EEV2 P (Pulse of The Outdoor Unit Expansion Valve EEV2)

● **Number 33 Details of Compressor protection status No. Models FDC90, 100VNP-W**

No.	Contents of display	Reference page
"0"	Normal	
"1"	Discharge pipe temperature protection control	P44, (11). (b). (i)
"2"	Discharge pipe temperature anomaly	P44, (11). (b). (ii)
"3"	Current safe control of inverter primary current	P45, (12)
"4"	High pressure protection control	P42, (6). (c), P43, (8), (b)
"5"	High pressure anomaly	P44, (11)
"8"	Anti-frost prevention control	
"9"	Current cut	P45, (13)
"11"	Power transistor anomaly (Overheat)	
"12"	Compression ratio control	
"13"	Spare	
"14"	Dewing prevention control	
"15"	Current safe control of inverter secondary current	
"16"	Stop by compressor rotor lock	
"17"	Stop by compressor startup failure	
"18"	Active filter anomaly	

Note(1) Operation data display on the remote control.

• Data is displayed until canceling the protection control.

• In case of multiple protections controlled, only the younger No. is displayed.

Note(2) Common item.

① In heating mode.

During protection control by the command signal for reducing compressor frequency from indoor unit, No. "4" is displayed.

② In cooling and dehumidifying mode.

During protection control by the command signal for reducing compressor frequency from indoor unit, No. "8" is displayed.

**(b) In case of RC-E5 remote control**

Operation data can be checked with remote control unit operation.

- ① Press the **CHECK** button.  
The display change “ OPER DATA ▼ ”
- ② Press the **(SET)** button while “ OPER DATA ▼ ” is displayed.
- ③ When only one indoor unit is connected to remote control, “ DATA LOADING ” is displayed (blinking indication during data loading).  
Next, operation data of the indoor unit will be displayed.  
Skip to step ⑦.

- ④ When plural indoor units is connected, the smallest address number of indoor unit among all connected indoor unit is displayed.

[Example]:

“ SELECT I/U ” (blinking 1 seconds) → “ I/U000 ▲ ” blinking.

- ⑤ Select the indoor unit number you would like to have data displayed with the **▲ ▼** button.
- ⑥ Determine the indoor unit number with the **(SET)** button.

(The indoor unit number changes from blinking indication to continuous indication)

“ I/U000 ” (The address of selected indoor unit is blinking for 2 seconds.)



“ DATA LOADING ” (A blinking indication appears while data loaded.) Next, the operation data of the indoor unit are indicated.

- ⑦ Upon operation of the **▲ ▼** button, the current operation data are displayed in order from data number 01. The items displayed are in the above table.

\*Depending on models, the items that do not have corresponding data are not displayed.

- ⑧ To display the data of a different indoor unit, press the **AIR CON No.** button, which allows you to go back to the indoor unit selection screen.
- ⑨ Pressing the **ON/OFF** button will stop displaying data.

Pressing the **(RESET)** button during remote control unit operation will undo your last operation and allow you to go back to the previous screen.

⊙If two (2) remote controls are connected to one (1) inside unit, only the master control is available for trial operation and confirmation of operation data. (The slave remote control is not available.)

● **Number 33 Details of compressor protection status No.**

Refer to page 60.

Number	Data Item
01	☼ (Operation Mode)
02	SET TEMP ℃ (Set Temperature)
03	RETURN AIR ℃ (Return Air Temperature)
04	SENSOR ℃ (Remote Control Temperature Sensor Temperature)
05	THI-R1 ℃ (Indoor Heat Exchanger Temperature Sensor / U Bend)
06	THI-R2 ℃ (Indoor Heat Exchanger Temperature Sensor / Capillary)
07	THI-R3 ℃ (Indoor Heat Exchanger Temperature Sensor / Gas Header)
08	I/U FANSPEED (Indoor Unit Fan Speed)
09	DEMAND Hz (Frequency Requirements)
10	ANSWER Hz (Response Frequency)
11	I/U EEV P (Pulse of Indoor Unit Expansion Valve)
12	TOTAL I/U RUN H (Total Running Hours of The Indoor Unit)
21	OUTDOOR ℃ (Outdoor Air Temperature)
22	THO-R1 ℃ (Outdoor Heat Exchanger Temperature Sensor)
23	THO-R2 ℃ (Outdoor Heat Exchanger Temperature Sensor)
24	COMP Hz (Compressor Frequency)
25	HP MPa (High Pressure)
26	LP MPa (Low Pressure)
27	Td ℃ (Discharge Pipe Temperature)
28	COMP BOTTOM ℃ (Compressor Bottom Temperature)
29	CT AMP (Current)
30	TARGET SH ℃ (Target Super Heat)
31	SH ℃ (Super Heat)
32	TDSH ℃ (Discharge Pipe Super Heat)
33	PROTECTION No. (Protection State No. of The Compressor)
34	O/U FANSPEED (Outdoor Unit Fan Speed)
35	63H1 (63H1 On/Off)
36	DEFROST (Defrost Control On/Off)
37	TOTAL COMP RUN H (Total Running Hours of The Compressor)
38	O/U EEV1 P (Pulse of The Outdoor Unit Expansion Valve EEVC)
39	O/U EEV2 P (Pulse of The Outdoor Unit Expansion Valve EEVH)

**(6) Power transistor module (Including the driver PCB) inspection procedure**

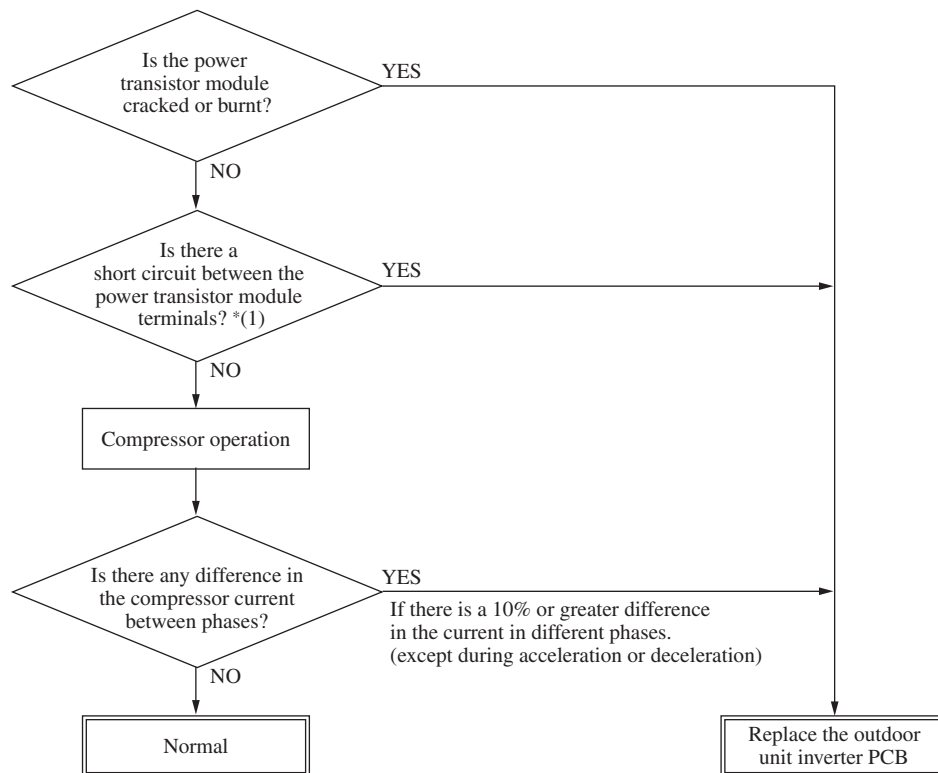

**\*(1) Power transistor module terminal short circuit check procedure**

Disconnect the compressor wiring, then conduct a short circuit check.

P-U, P-V, P-W

N-U, N-V, N-W

Check between the P-N terminals.

Bring the tester probes in contact with the following places on each terminal.

P: Power transistor P terminal,

N: Power transistor N terminal,

U: End of red harness to compressor

V: End of white harness to compressor

W: End of black or blue harness to compressor

Check for a power transistor short-circuit.

- When you do not have a diagnostic checker for judging if the inverter is defective, measure between the terminals of the power transistor parts, judge whether the power transistor is defective or not.
- Disconnect the compressor, then measure with the control incorporated.

**Model FDC90, 100VNP-W**

Tester		Normal values (Ω)	Diode mode (V)
Terminal (+)	Terminal (-)		
P	N	A few of MΩ (Not short)	—
N	P		
P	U		
P	V		
P	W		
N	U		
N	V		
N	W		
U	P		
V	P		
W	P		
U	N		—
V	N		
W	N		

If the measured values range from 0 - several kΩ, there is a possibility that the elements are damaged, so replace the power transistor parts.

(7) Inverter checker for diagnosis of inverter output

● Checking method

- (i) Setup procedure of checker.
  - 1) Power OFF (Turn off the breaker).
  - 2) Remove the terminal cover of compressor and disconnect the wires (U, V, W) from compressor.
  - 3) Connect the wires U (Red), V (White) and W (Black) of checker to the terminal of disconnected wires (U, V, W) from compressor respectively.
  - 4) Connect the short connector to CNROM on the main PCB.
- (ii) Operation for judgment.
  - 1) Power ON.
  - 2) After 15 seconds since power has turned ON, LED start ON/OFF for 5 seconds cyclically and it repeats 10 times.
  - 3) Check ON/OFF status of 6 LED's on the checker.
  - 4) Judge the PCB by ON/OFF status of 6 LED's on the checker.

ON/OFF status of LED	If all of LED are ON/OFF according to following pattern	If all of LED stay OFF or some of LED are ON/OFF
Control PCB	Normal	Anomalous

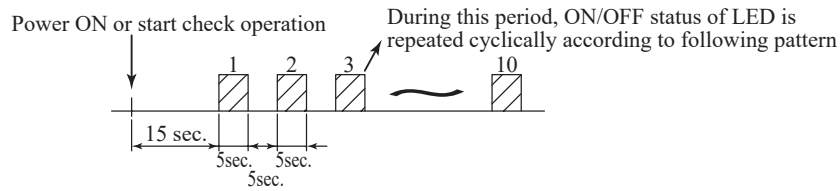

- 5) Be sure to disconnect the connector from CNROM, after finishing the check operation.

<Inverter Checker>

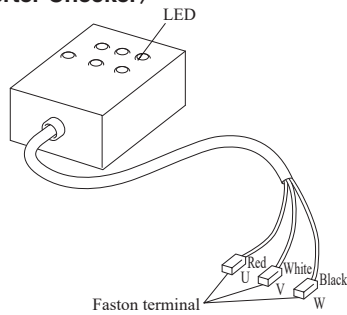

LED ON/OFF pattern

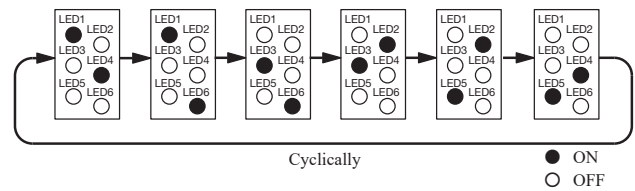

Connect to the terminal of the wires which are disconnected from compressor.

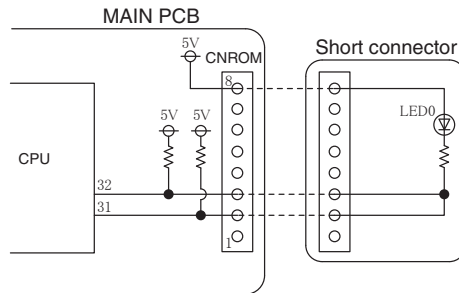



(8) Outdoor unit control failure diagnosis circuit diagram  
Model FDC90, 100VNP-W

● Check point of outdoor unit

**⚠ CAUTION - HIGH VOLTAGE**  
High voltage is produced in the control box. Don't touch electrical parts in the control box for 5 minutes after the units stopped.

Color symbol

BK	Black
BL	Blue
RD	Red
WH	White
YE	Yellow
YG	Yellow/Green

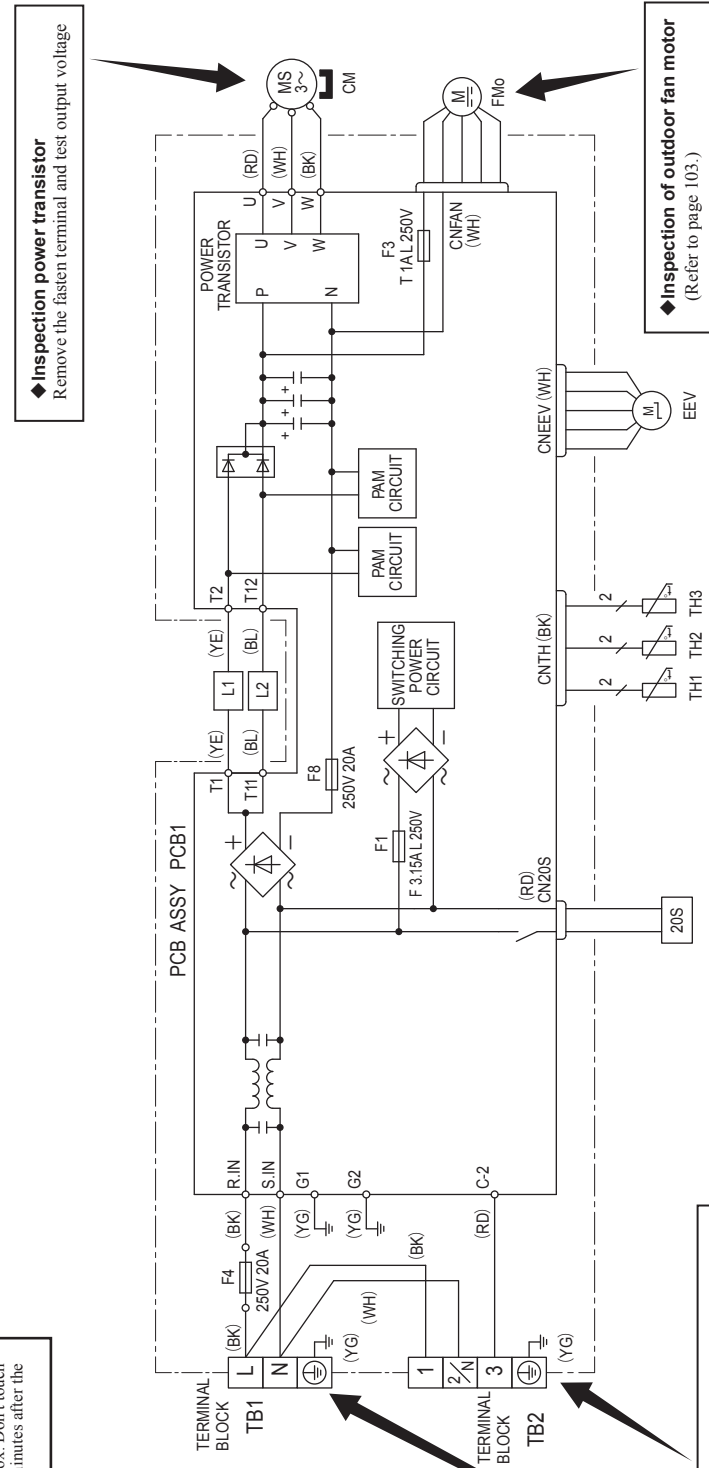

◆ Inspection power transistor  
Remove the fasten terminal and test output voltage

◆ Inspection of outdoor fan motor  
(Refer to page 103.)

◆ Power source and serial signal inspection  
 ① to ②: AC 220/230/240V  
 ① to ②(N): AC 220/230/240V  
 ②(N) to ③: Normal if the voltage oscillates between DC 0 and approx. 20V

## 2.1.2 Troubleshooting flow

### (1) List of troubles

#### Model FDC90, 100VNP-W

Remote control display	Description of trouble	Reference page
None	Operates but does not cool.	66
None	Operates but does not heat.	67
None	Earth leakage breaker activated	68
None	Excessive noise/vibration (1/3)	69
None	Excessive noise/vibration (2/3)	70
None	Excessive noise/vibration (3/3)	71
None	Louver motor failure (FDT, FDE series)	72
None	Power source system error (Power source to indoor unit control PCB)	73
None	Power source system error (Power source to remote control)	74
INSPECT I/U	INSPECT I/U (When 1 or 2 remote controls are connected)	75
INSPECT I/U	INSPECT I/U (Connection of 3 units or more remote controls)	76
🕒 WAIT 🕒	Communication error at initial operation	77-79
E1	Remote control communication circuit error	80
E5	Communication error during operation	81
E6	Indoor heat exchanger temperature sensor anomaly	82
E7	Return air temperature sensor anomaly	83
E8	Heating overload operation	84
E9	Drain trouble (FDT, FDU, FDUM series)	85
E10	Excessive number of connected indoor units (more than 17 units) by controlling with one remote control	86
E11	Address setting error of indoor units	87
E14	Communication error between master and slave indoor units	88
E16	Indoor fan motor anomaly	89
E18	Address setting error of master and slave indoor units	90
E19	Indoor unit operation check, drain pump motor check setting error	91
E20	Indoor fan motor rotation speed anomaly	92
E28	Remote control temperature sensor anomaly	93
E35	Cooling overload operation	94
E36	Discharge pipe temperature error	95
E37	Outdoor heat exchanger temperature sensor anomaly	96
E38	Outdoor air temperature sensor anomaly	97
E39	Discharge pipe temperature sensor anomaly	98
E40	Service valve (gas side) closing operation	99
E42	Current cut	100 · 101
E47	Active filter voltage error	102
E48	Outdoor fan motor anomaly	103
E51	Power transistor anomaly	104
E57	Insufficient refrigerant amount or detection of service valve closure	105
E58	Current safe stop	106
E59	Compressor startup failure	107
E60	Compressor rotor lock error	108

(2) Troubleshooting

Error code Remote control: None	LED	Green	Red	Content <b>Operates but does not cool</b>
	Indoor	Keeps flashing	Stays OFF	

<p>1. Applicable model</p> <p>All models</p>	5. Troubleshooting	
<p>2. Error detection method</p>	Diagnosis	Countermeasure
<p>3. Condition of Error displayed</p>	<pre> graph TD     Start[Check the indoor unit fan operation. Check the temperature difference between return and supply air.] --&gt; D1{Is the temperature difference between return and supply air 10-20°C at cooling?}     D1 -- YES --&gt; D2{Does the heat load increase after installtion?}     D1 -- NO --&gt; D3{Is the compressor operating?}     D2 -- YES --&gt; B1[Mistake in model selection. Calculate heat load once more.]     D2 -- NO --&gt; D4{“WAIT” message is displayed (for 3 seconds) when performing cooling, defrosting and heating operations from the remote control.}     B1 --&gt; C1[It is necessary to replace to higher capacity one or to install additional unit.]     D3 -- NO --&gt; D4     D3 -- YES --&gt; D5{Is the compressor rotation speed low?}     D4 -- YES --&gt; C2[Compressor refrigerant oil protection control at starting is activated.]     D4 -- NO --&gt; C3[Compressor may be stopped by the error detection control. For the contents of control, refer to anomalous stop control by controlling compressor rotation speed of microcomputer control functions.]     D5 -- NO --&gt; C4[Inspect the followings. • Minor clogging of filter • Minor clogging of heat exchanger • Minor short-circuit • Minor shortage of refrigerant amount • Poor compression of compressor]     D5 -- YES --&gt; B2[Check which control “Determination control of compressor rotation speed” or “Protective control by controlling compressor rotation speed” is appropriate to this phenomenon.]     B2 --&gt; D6{Are the temperature conditions of room and outdoor air close to the rated conditions?}     D6 -- YES --&gt; C5[Considering appropriate operation control, check suspicious points. Inspect the followings for reference. • Major clogging of filter • Major clogging of heat exchanger • Major short-circuit • Major shortage of refrigerant amount • Compressor protection ON • Indoor fan tap]     D6 -- NO --&gt; B3[The unit is operating normally but is operating under the contol for protecting compressor or other respective parts.]             </pre>	
<p>4. Presumable cause</p> <ul style="list-style-type: none"> <li>• Poor compression of compressor</li> <li>• Faulty expansion valve operation</li> </ul>		

Note:

Error code Remote control: None	LED	Green	Red	Content <b>Operates but does not heat</b>
	Indoor	Keeps flashing	Stays OFF	

<b>1. Applicable model</b>	<b>5. Troubleshooting</b>		
All models	<b>Diagnosis</b>		<b>Countermeasure</b>
<b>2. Error detection method</b>	<p>Check the indoor unit fan operation. Check the temperature difference between return and supply air.</p> <pre> graph TD     Start[Check the indoor unit fan operation. Check the temperature difference between return and supply air.] --&gt; D1{Is the temperature difference between return and supply air 10-30°C at heating?}     D1 -- YES --&gt; D2{Does the heat load increase after installation?}     D1 -- NO --&gt; D3{Is the compressor operating?}     D2 -- YES --&gt; B1[Mistake in model selection. Calculate heat load once again.]     D2 -- NO --&gt; C1[It is normal. (This unit is designed to start in the soft start mode by detecting the under dome temperature of compressor when it restart after power reset.)]     B1 --&gt; C2[It is necessary to replace to higher capacity one or to install additional unit.]     D3 -- NO --&gt; D4{"⏸️WAIT⏸️" message is displayed (for 3 seconds) when performing cooling, defrosting and heating operations from the remote control.}     D3 -- YES --&gt; D5{Is the compressor rotation speed low?}     D4 -- YES --&gt; C3[Compressor refrigerant oil protection control at starting is activated.]     D4 -- NO --&gt; C4[Compressor may be stopped by the error detection control. For the contents of control, refer to anomalous stop control by controlling compressor rotation speed of microcomputer control functions.]     D5 -- NO --&gt; C5[Inspect the followings. • Minor clogging of filter • Minor clogging of heat exchanger • Minor short-circuit • Minor shortage of refrigerant amount • Poor compression of compressor]     D5 -- YES --&gt; B2[Check which control "Determination control of compressor rotation speed" or "Protective control by controlling compressor rotation speed" is appropriate to this phenomenon.]     B2 --&gt; D6{Are the (1) temperature conditions of room and outdoor air close to the rated conditions?}     D6 -- YES --&gt; C6[Considering appropriate operation control, check suspicious points. Inspect the followings for reference. • Major clogging of filter • Major clogging of heat exchanger • Major short-circuit • Major shortage of refrigerant amount • Compressor protection ON • Indoor fan tap]     D6 -- NO --&gt; B3[The unit is operating normally but is operating under the control for protecting compressor or other respective parts.]                     </pre>		<p>It is normal. (This unit is designed to start in the soft start mode by detecting the under dome temperature of compressor when it restart after power reset.)</p> <p>It is necessary to replace to higher capacity one or to install additional unit.</p> <p>Compressor refrigerant oil protection control at starting is activated.</p> <p>Compressor may be stopped by the error detection control. For the contents of control, refer to anomalous stop control by controlling compressor rotation speed of microcomputer control functions.</p> <p>Inspect the followings.</p> <ul style="list-style-type: none"> <li>• Minor clogging of filter</li> <li>• Minor clogging of heat exchanger</li> <li>• Minor short-circuit</li> <li>• Minor shortage of refrigerant amount</li> <li>• Poor compression of compressor</li> </ul> <p>Considering appropriate operation control, check suspicious points. Inspect the followings for reference.</p> <ul style="list-style-type: none"> <li>• Major clogging of filter</li> <li>• Major clogging of heat exchanger</li> <li>• Major short-circuit</li> <li>• Major shortage of refrigerant amount</li> <li>• Compressor protection ON</li> <li>• Indoor fan tap</li> </ul>
<b>3. Condition of Error displayed</b>			
<b>4. Presumable cause</b>	<ul style="list-style-type: none"> <li>• Faulty 4-way valve operation</li> <li>• Poor compression of compressor</li> <li>• Faulty expansion valve operation</li> </ul>		

Note:

Error code Remote control: None	LED	Green	Red	Content <b>Earth leakage breaker activated</b>
	Indoor	Stays OFF	Stays OFF	

<b>1. Applicable model</b>	<b>5. Troubleshooting</b>		
All models	<b>Diagnosis</b>		<b>Countermeasure</b>
<b>2. Error detection method</b>	<pre> graph TD     D1{Are OK the insulation resistance and coil resistance of compressor?}     D2{Is insulation of respective harnesses OK? Is any harness bitten between pannel and casing or etc?}     C1[Check the outdoor unit grounding wire/earth leakage breaker.]          D1 -- NO --&gt; CM1[Replace compressor.*]     D1 -- YES --&gt; D2     D2 -- NO --&gt; CM2[Secure insulation resistance.]     D2 -- YES --&gt; C1         </pre>		
<b>3. Condition of Error displayed</b>	<p>Check of the outdoor unit grounding wire/earth leakage breaker</p> <p>① Run an independent grounding wire from the grounding screw of outdoor unit to the grounding terminal on the distribution panel. (Do not connect to another grounding wire.)</p> <p>② In order to prevent malfunction of the earth leakage breaker itself, confirm that it is conformed to higher harmonic regulation.</p> <p>* Insulation resistance of compressor</p> <ul style="list-style-type: none"> <li>• Immediately after installation or when the unit has been left for long time without power source, the insulation resistance may drop to a few MΩ because of refrigerant migrated in the compressor.</li> </ul> <p>When the earth breaker is activated at lower insulation resistance, check the following points.</p> <p>① Check if the earth leakage breaker is conformed to higher harmonic regulation or not.</p> <p>Since the unit is equipped with inverter, it is necessary to use components conformed to higher harmonic regulation in order to prevent malfunction of earth leakage breaker.</p>		
<b>4. Presumable cause</b>	<ul style="list-style-type: none"> <li>• Defective compressor</li> <li>• Noise</li> </ul>		

Note:

Error code Remote control: None	LED	Green	Red	Content <b>Excessive noise/vibration (1/3)</b>
	Indoor	-	-	

<b>1. Applicable model</b>
All models

<b>2. Error detection method</b>

<b>3. Condition of Error displayed</b>

<b>4. Presumable cause</b>
<ul style="list-style-type: none"> <li>① Improper installation work             <ul style="list-style-type: none"> <li>• Improper anti-vibration work at installation</li> <li>• Insufficient strength of mounting face</li> </ul> </li> <li>② Defective product             <ul style="list-style-type: none"> <li>• Before/after shipping from factory</li> </ul> </li> <li>③ Improper adjustment during commissioning             <ul style="list-style-type: none"> <li>• Excess/shortage of refrigerant, etc.</li> </ul> </li> </ul>

<b>5. Troubleshooting</b>	
<b>Diagnosis</b>	<b>Countermeasure</b>
<pre> graph TD     D1{Does noise/vibration occur during or soon after stopping operation of air-conditioner?}     D2{[Installation work] Does noise/vibration occur not only from the air-conditioner but also from entire building?}     D3{Does the installation of indoor/outdoor unit loose?}     D4{Are pipes touching the wall, etc?}     D5{[Product] Does noise/vibration occur from operating fan (fan only)?}     D6{Is there a fan or louver touching other components?}     C1[To next page]      D1 -- NO --&gt; CM1     D1 -- YES --&gt; D2     D2 -- YES --&gt; D3     D2 -- NO --&gt; D4     D3 -- YES --&gt; CM2     D3 -- NO --&gt; D4     D4 -- YES --&gt; CM3     D4 -- NO --&gt; CM4     D5 -- YES --&gt; D6     D5 -- NO --&gt; C1     D6 -- YES --&gt; CM5     D6 -- NO --&gt; CM6     </pre>	<p>If excessive noise/vibration persists when sufficient time has elapsed after stopping the unit, it is considered that the air-conditioner is not the source.</p> <p>Check the installed condition carefully, and correct the position or insert rubber cushions or others into the gap, if necessary.</p> <p>Prevent the vibration from transmitting to wall and etc by fixing pipes on the wall or wrapping rubber cushion around the pipe which goes through the hole in the wall or applying other appropriate means.</p> <p>Strength of ceiling wall, floor, etc. may be insufficient. Review the installing position or reinforce it.</p> <p>Check for leaning of installed unit or anomalous mounting of fan, louver or motor and specify the contacting point and correct it.</p> <p>When the heat exchanger or filter is clogged, clean them. In case that the unit is installed at the site where background noise is very low, small noise from indoor unit can be heard, but it is normal. Before installation, check for background noise. If background noise is very low, convince client prior to installation.</p>

Note:

<table border="1"> <tr> <td>Error code</td> <td>LED</td> <td>Green</td> <td>Red</td> <td>Content</td> </tr> <tr> <td>Remote control: None</td> <td>Indoor</td> <td>–</td> <td>–</td> <td>Excessive noise/vibration (2/3)</td> </tr> </table>	Error code	LED	Green	Red	Content	Remote control: None	Indoor	–	–	Excessive noise/vibration (2/3)
Error code	LED	Green	Red	Content						
Remote control: None	Indoor	–	–	Excessive noise/vibration (2/3)						

<p>1. Applicable model</p> <p>All models</p>	<p>5. Troubleshooting</p>	
<p>2. Error detection method</p>	<p>Diagnosis</p>	<p>Countermeasure</p>
<p>3. Condition of Error displayed</p>		
<p>4. Presumable cause</p>		

Note:

<table border="1"> <tr> <td>Error code</td> <td>LED</td> <td>Green</td> <td>Red</td> <td>Content</td> </tr> <tr> <td>Remote control: None</td> <td>Indoor</td> <td>–</td> <td>–</td> <td>Excessive noise/vibration (3/3)</td> </tr> </table>	Error code	LED	Green	Red	Content	Remote control: None	Indoor	–	–	Excessive noise/vibration (3/3)
Error code	LED	Green	Red	Content						
Remote control: None	Indoor	–	–	Excessive noise/vibration (3/3)						

<p>1. Applicable model</p> <p>All models</p>	<p>5. Troubleshooting</p> <table border="1" style="width: 100%;"> <thead> <tr> <th style="width: 50%;">Diagnosis</th> <th style="width: 50%;">Countermeasure</th> </tr> </thead> <tbody> <tr> <td style="text-align: center;"> <div style="border: 1px solid black; padding: 5px; width: fit-content; margin: 0 auto;">From previous page</div> <p>↓</p> <div style="border: 1px solid black; padding: 10px; width: fit-content; margin: 0 auto;"> <p style="text-align: center;">Adjustment during commissioning</p> <p style="text-align: center;">Does noise/vibration occur when the cooling/heating operation is in anomalous condition?</p> </div> <p style="text-align: right; margin-right: 20px;">→ YES →</p> </td> <td style="vertical-align: top; padding: 10px;"> <p>If insufficient cooling/heating problem happens due to anomalous operating conditions at cooling/heating, followings are suspicious.</p> <ul style="list-style-type: none"> <li>Overcharge of refrigerant</li> <li>Insufficient charge of refrigerant</li> <li>Intrusion of air, nitrogen, etc.</li> </ul> <p>In such occasion, it is necessary to recover refrigerant, vacuum-dry and recharge refrigerant.</p> <p>* Since there could be many causes of noise/vibration, the above do not cover all. In such case, check the conditions when, where, how the noise/vibration occurs according to following check point.</p> <ul style="list-style-type: none"> <li>Indoor/outdoor unit</li> <li>Cooling/heating/fan mode</li> <li>Startup/stop/during operation</li> <li>Operating condition (Indoor/outdoor temperatures, pressure)</li> <li>Time it occurred</li> <li>Operation data retained by the remote control such as compressor rotation speed, heat exchanger temperature, EEV opening degree, etc.</li> <li>Tone (If available, record the noise)</li> <li>Any other anomalies</li> </ul> </td> </tr> </tbody> </table>		Diagnosis	Countermeasure	<div style="border: 1px solid black; padding: 5px; width: fit-content; margin: 0 auto;">From previous page</div> <p>↓</p> <div style="border: 1px solid black; padding: 10px; width: fit-content; margin: 0 auto;"> <p style="text-align: center;">Adjustment during commissioning</p> <p style="text-align: center;">Does noise/vibration occur when the cooling/heating operation is in anomalous condition?</p> </div> <p style="text-align: right; margin-right: 20px;">→ YES →</p>	<p>If insufficient cooling/heating problem happens due to anomalous operating conditions at cooling/heating, followings are suspicious.</p> <ul style="list-style-type: none"> <li>Overcharge of refrigerant</li> <li>Insufficient charge of refrigerant</li> <li>Intrusion of air, nitrogen, etc.</li> </ul> <p>In such occasion, it is necessary to recover refrigerant, vacuum-dry and recharge refrigerant.</p> <p>* Since there could be many causes of noise/vibration, the above do not cover all. In such case, check the conditions when, where, how the noise/vibration occurs according to following check point.</p> <ul style="list-style-type: none"> <li>Indoor/outdoor unit</li> <li>Cooling/heating/fan mode</li> <li>Startup/stop/during operation</li> <li>Operating condition (Indoor/outdoor temperatures, pressure)</li> <li>Time it occurred</li> <li>Operation data retained by the remote control such as compressor rotation speed, heat exchanger temperature, EEV opening degree, etc.</li> <li>Tone (If available, record the noise)</li> <li>Any other anomalies</li> </ul>
Diagnosis	Countermeasure					
<div style="border: 1px solid black; padding: 5px; width: fit-content; margin: 0 auto;">From previous page</div> <p>↓</p> <div style="border: 1px solid black; padding: 10px; width: fit-content; margin: 0 auto;"> <p style="text-align: center;">Adjustment during commissioning</p> <p style="text-align: center;">Does noise/vibration occur when the cooling/heating operation is in anomalous condition?</p> </div> <p style="text-align: right; margin-right: 20px;">→ YES →</p>	<p>If insufficient cooling/heating problem happens due to anomalous operating conditions at cooling/heating, followings are suspicious.</p> <ul style="list-style-type: none"> <li>Overcharge of refrigerant</li> <li>Insufficient charge of refrigerant</li> <li>Intrusion of air, nitrogen, etc.</li> </ul> <p>In such occasion, it is necessary to recover refrigerant, vacuum-dry and recharge refrigerant.</p> <p>* Since there could be many causes of noise/vibration, the above do not cover all. In such case, check the conditions when, where, how the noise/vibration occurs according to following check point.</p> <ul style="list-style-type: none"> <li>Indoor/outdoor unit</li> <li>Cooling/heating/fan mode</li> <li>Startup/stop/during operation</li> <li>Operating condition (Indoor/outdoor temperatures, pressure)</li> <li>Time it occurred</li> <li>Operation data retained by the remote control such as compressor rotation speed, heat exchanger temperature, EEV opening degree, etc.</li> <li>Tone (If available, record the noise)</li> <li>Any other anomalies</li> </ul>					
<p>2. Error detection method</p>						
<p>3. Condition of Error displayed</p>						
<p>4. Presumable cause</p>						

Note:



<b>Error code</b> Remote control: None	LED	Green	Red	<b>Content</b> <h2 style="text-align: center;">Louver motor failure (FDT, FDE series)</h2>
	Indoor	Keeps flashing	Stays OFF	

<b>1.Applicable model</b> FDT, FDE series only
---

<b>2.Error detection method</b>
---------------------------------

<b>3. Condition of Error displayed</b>
--

<b>4.Presumable cause</b> <ul style="list-style-type: none"> <li>• Defective LM</li> <li>• LM wire breakage</li> <li>• Faulty indoor unit control PCB</li> </ul>
---

<b>5.Troubleshooting</b>	
<b>Diagnosis</b>	<b>Countermeasure</b>
<p style="text-align: center;">▲ Check at the indoor unit side.</p> <div style="text-align: center;"> <div style="border: 1px solid black; padding: 2px; width: fit-content; margin: 0 auto;">Operate after waiting for more than 1 minute.</div> <p>↓</p> <div style="display: flex; justify-content: center; align-items: center;"> <div style="border: 1px solid black; padding: 5px; margin-right: 10px;">Does the louver operate at the power on?</div> <div style="margin-left: 10px;"> <p>NO →</p> <div style="border: 1px solid black; padding: 5px; margin: 5px auto;">Is LM wiring broken?</div> <p>NO →</p> <div style="border: 1px solid black; padding: 5px; margin: 5px auto;">Is LM locked?</div> <p>NO →</p> <div style="border: 1px solid black; padding: 5px; margin: 5px auto;">Is the louver operable with the remote control?</div> </div> </div> <p>YES →</p> </div> <pre> graph TD     Start[Operate after waiting for more than 1 minute.] --&gt; Q1{Does the louver operate at the power on?}     Q1 -- NO --&gt; Q2{Is LM wiring broken?}     Q2 -- YES --&gt; C1[Repair wiring.]     Q2 -- NO --&gt; Q3{Is LM locked?}     Q3 -- YES --&gt; C2[Replace LM.]     Q3 -- NO --&gt; C3[Defective indoor unit control PCB → Replace.]     Q1 -- YES --&gt; Q4{Is the louver operable with the remote control?}     Q4 -- YES --&gt; C4[Normal]     Q4 -- NO --&gt; C5[Adjust LM lever and then check again.]     </pre> <p style="text-align: center;">LM: louver motor</p>	

<b>Note:</b>
--------------



Error code Remote control: None	LED	Green	Red	Content <b>Power source system error (Power source to remote control)</b>
	Indoor	Keeps flashing	Stays OFF	

<b>1.Applicable model</b>	<b>5.Troubleshooting</b>		
All models	<b>Diagnosis</b>	<b>Countermeasure</b>	
<b>2.Error detection method</b>	<pre> graph TD     D1{Isn't there any loose connection of remote control wires?}     D2{Isn't remote control wire broken or short-circuited?}     P1[Disconnect remote control wires.]     D3{Is DC15V or higher detected between X-Y of indoor unit terminal block?}     D4{Is DC180V between ①-② of CNW2?}          D1 -- YES --&gt; C1[Correct.]     D1 -- NO --&gt; D2     D2 -- YES --&gt; C2[Replace wires.]     D2 -- NO --&gt; P1     P1 --&gt; D3     D3 -- YES --&gt; C3[Replace remote control.]     D3 -- NO --&gt; D4     D4 -- YES --&gt; C4[Defective indoor unit control PCB→Replace.]     D4 -- NO --&gt; C5[Defective indoor unit power PCB→Replace.]         </pre>		
<b>3.Condition of Error displayed</b>			
<b>4.Presumable cause</b>	<ul style="list-style-type: none"> <li>• Remote control wire breakage/short-circuit</li> <li>• Defective remote control</li> <li>• Malfunction by noise</li> <li>• Faulty indoor unit power PCB</li> <li>• Broken harness</li> <li>• Faulty indoor unit control PCB</li> </ul>		

Note:

Error code Remote control: INSPECT I/U	LED	Green	Red	Content <b>INSPECT I/U</b> (When 1 or 2 remote controls are connected)
	Indoor	Keeps flashing	Stays OFF	

<b>1. Applicable model</b>
All models
<b>2. Error detection method</b>
Communication between indoor unit and remote control is disabled for more than 30 minutes after the power on.
<b>3. Condition of Error displayed</b>
Same as above
<b>4. Presumable cause</b>
<ul style="list-style-type: none"> <li>• Improper setting</li> <li>• Surrounding environment</li> <li>• Defective remote control communication circuit</li> <li>• Faulty indoor unit control PCB</li> </ul>

<b>5. Troubleshooting</b>	
<b>Diagnosis</b>	<b>Countermeasure</b>
<pre> graph TD     Q1{Are 2 units of remote control connected?}     Q2{Is it set at the slave remote control?}     Q3{Does it become normal?}     Q4{Do more than one indoor units have the same address?}     Q5{Are remote control wires laid along high voltage wires?}     Q6{Does DM start 60 seconds later automatically.}          Q1 -- YES --&gt; S1[Set one remote control for "Master" and the other for "Slave"]     S1 --&gt; Q3     Q3 -- NO --&gt; Q2     Q1 -- NO --&gt; Q2          Q2 -- YES --&gt; C1[Set SW1 on remote control PCB at "Master".]     Q2 -- NO --&gt; Q4          Q3 -- YES --&gt; Q4          Q4 -- YES --&gt; C2[Set address again. (SW2 on indoor unit control PCB)]     Q4 -- NO --&gt; Q5          Q5 -- YES --&gt; C3[Separate remote control wires from high voltage wires.]     Q5 -- NO --&gt; S2[Disconnect the connecting wire ③ between the indoor and outdoor unit.]     S2 --&gt; S3[Power source reset]     S3 --&gt; Q6          Q6 -- YES --&gt; C4[Defective indoor unit control PCB -&gt; Replace.]     Q6 -- NO --&gt; C5[Defective remote control -&gt; Change.]     </pre>	

Note: If any error is detected 30 minutes after displaying “WAIT” on the remote control, the display changes to “INSPECT I/U”.

Error code Remote control: INSPECT I/U	LED	Green	Red	Content <b>INSPECT I/U</b> (Connection of 3 units or more remote controls)
	Indoor	Keeps flashing	Stays OFF	

<b>1. Applicable model</b>
All models
<b>2. Error detection method</b>
Indoor unit cannot communicate for more than 30 minutes after the power on with remote control.
<b>3. Condition of Error displayed</b>
Same as above
<b>4. Presumable cause</b>
<ul style="list-style-type: none"> <li>• Improper setting</li> <li>• Surrounding environment</li> <li>• Defective remote control communication circuit</li> <li>• Faulty indoor unit control or power PCB</li> <li>• Faulty outdoor unit PCB</li> </ul>

<b>5. Troubleshooting</b>	
<b>Diagnosis</b>	<b>Countermeasure</b>

Note: If any error is detected 30 minutes after displaying “WAIT” on the remote control, the display changes to “INSPECT I/U”.

Error code Remote control: 🏠WAIT🏠	LED	Green	Red	Content <b>Communication error at initial operation (1/3)</b>
	Indoor	Keeps flashing	Stays OFF	

**1.Applicable model**  
All models  
When the remote control LCD displays “🏠WAIT🏠” 2 minutes after the power on.

**2.Error detection method**

**3.Condition of Error displayed**

**4.Presumable cause**

- Blown fuse
- Faulty outdoor unit PCB
- Connection between PCB's
- Faulty indoor unit control PCB
- Defective remote control
- Broken remote control wire

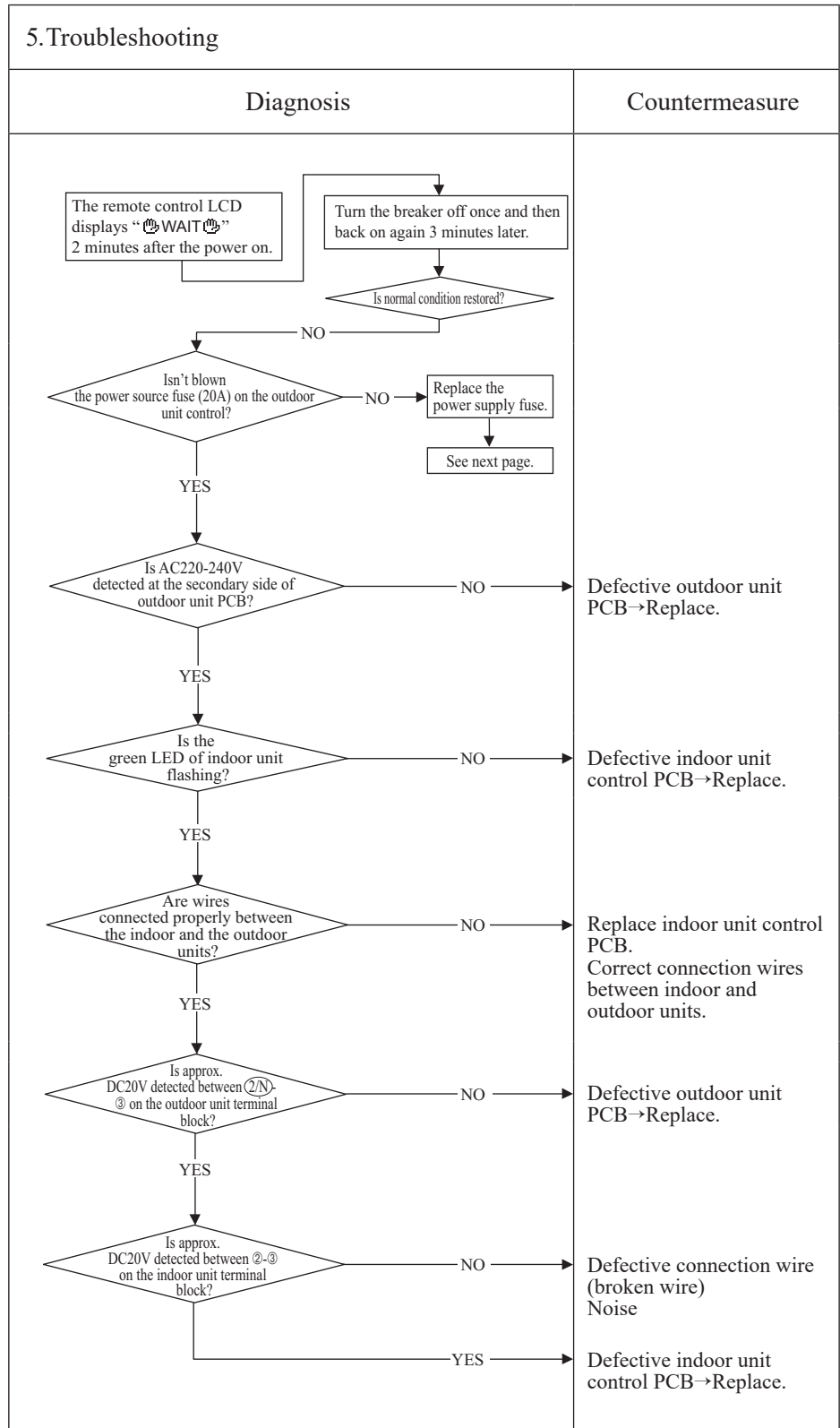

Note: If any anomaly is detected during communication, the error code E5 is displayed. Inspection procedure is same as above. (Excluding matters related to connection) When the power source is reset after the occurrence of E5, the LED will display “🏠WAIT🏠” if the anomaly continues. If the breaker ON/OFF is repeated in a short period of time (within 1 minute), “🏠WAIT🏠” may be displayed. In such occasion, turn the breaker off and wait for 3 minutes.

Error code Remote control: 🏠 WAIT 🏠	LED	Green	Red	Content <b>Communication error at initial operation (2/3)</b>
	Indoor	Keeps flashing	Stays OFF	

**1. Applicable model**  
All models  
When the fuse is blown, the method to inspect outdoor unit PCB before replacing the power source fuse

**2. Error detection method**

**3. Condition of Error displayed**

**4. Presumable cause**

- Blown fuse
- Faulty outdoor unit PCB
- Faulty reactor

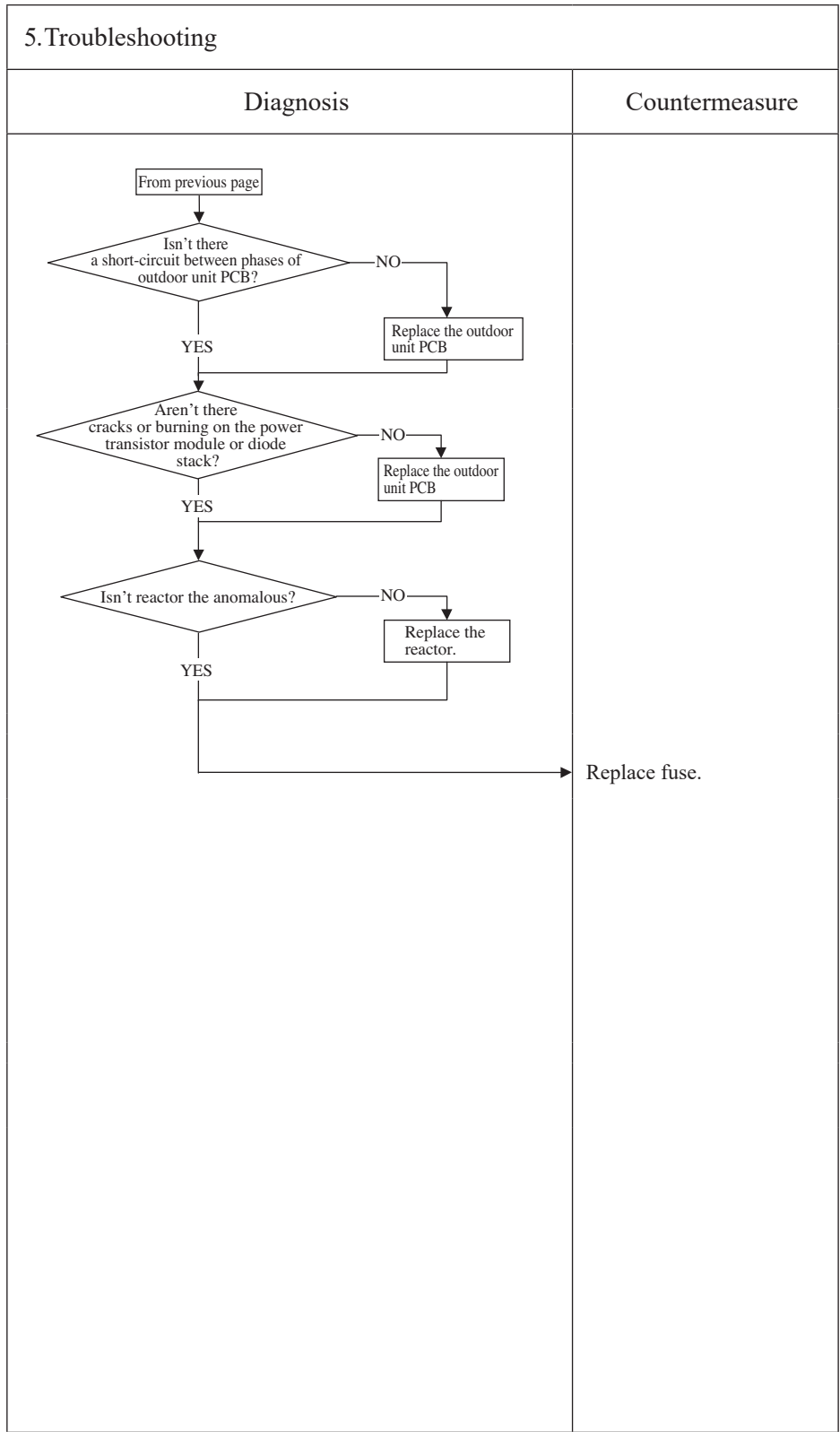

**Note:**

Error code Remote control: 🖱️ WAIT 🖱️	LED	Green	Red	Content <b>Communication error at initial operation (3/3)</b>
	Indoor	Keeps flashing	Stays OFF	

**1. Applicable model**  
All models  
When the remote control display is extinguished after the power on.

**2. Error detection method**

**3. Condition of Error displayed**

**4. Presumable cause**

- Blown fuse
- Connection between PCB's
- Blown fuse
- Faulty indoor unit control PCB
- Defective remote control
- Wire breakage on remote control
- Faulty outdoor unit PCB

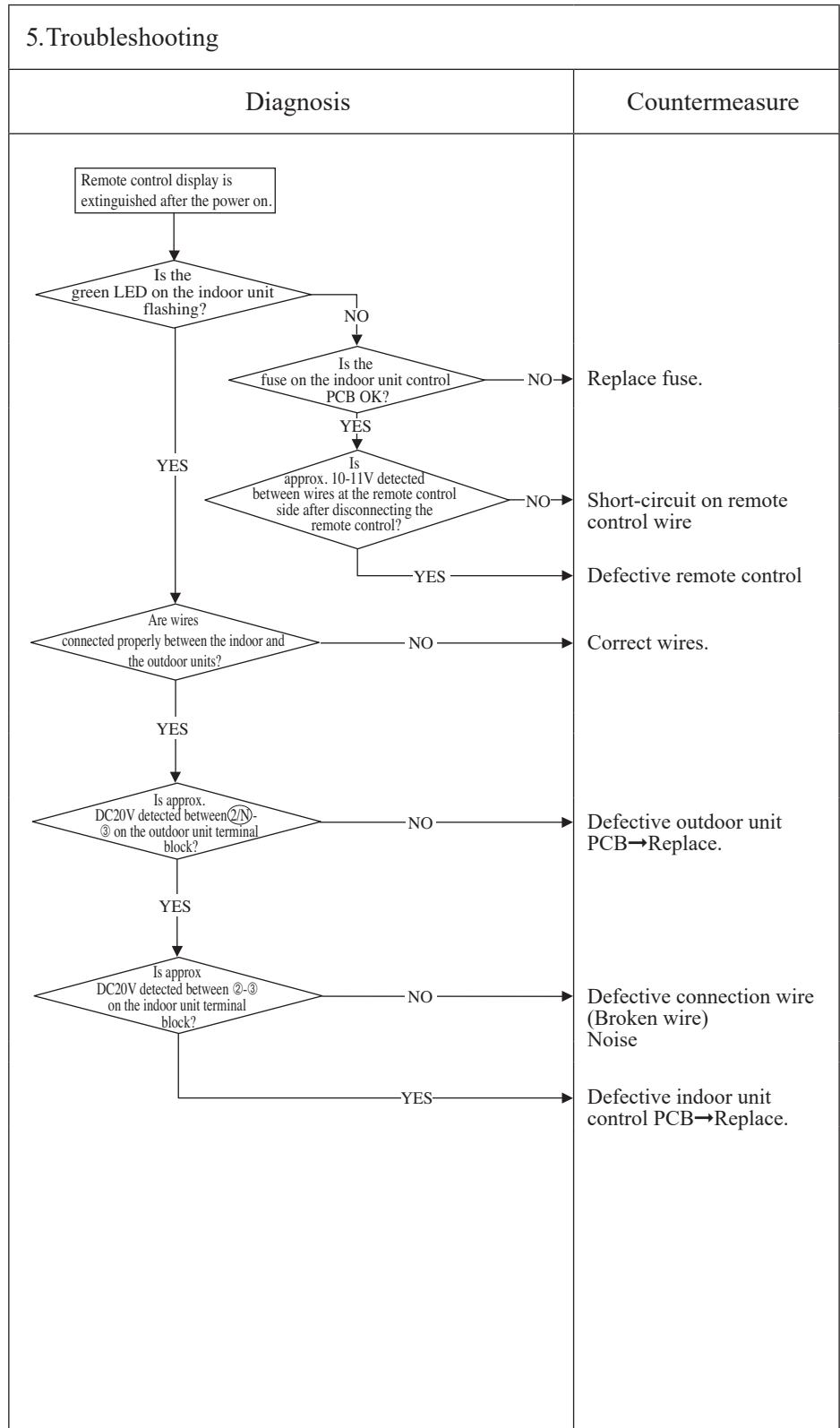

**Note:**



Error code Remote control: E1	LED	Green	Red	Content
	Indoor	Keeps flashing	Stays OFF	

## Remote control communication circuit error

<b>1. Applicable model</b>
All models
<b>2. Error detection method</b>
When normal communication between the remote control and the indoor unit is interrupted for more than 2 minutes. (Detectable only with the remote control)
<b>3. Condition of Error displayed</b>
Same as above
<b>4. Presumable cause</b>
<ul style="list-style-type: none"> <li>• Defective communication circuit between remote control-indoor unit</li> <li>• Noise</li> <li>• Defective remote control</li> <li>• Faulty indoor unit control PCB</li> </ul>

<b>5. Troubleshooting</b>	
<b>Diagnosis</b>	<b>Countermeasure</b>
<pre> graph TD     A{Is it possible to reset normally by the power reset?} -- YES --&gt; B[Malfunction by noise Check peripheral environment.]     A -- NO --&gt; C[Turn SW7-1 to OFF. → ON Remove the wire ③ connecting between indoor/outdoor units.]     C --&gt; D[Power source reset]     D --&gt; E{Does the drain pump restart automatically 1 minute later?}     E --- F[Note (1) Only indoor unit with drain pump]     E -- YES --&gt; G[Defective indoor unit control PCB → Replace.]     E -- NO --&gt; H[Connect the wire ③ connecting between indoor / outdoor units.]     H --&gt; I[Move to E5. (Communication error during operation) check.]     </pre>	

**Note:** If the indoor unit cannot communicate normally with the remote control for 180 seconds, the indoor unit PCB starts to reset automatically.

Error code Remote control: E5	LED	Green	Red	Content <b>Communication error during operation</b>
	Indoor	Keeps flashing	2-time flash	

<b>1.Applicable model</b>
All models

<b>2.Error detection method</b>
When normal communication between indoor and outdoor unit is interrupted for more than 2 minutes.

<b>3.Condition of Error displayed</b>
Same as above is detected during operation.

<b>4.Presumable cause</b>
<ul style="list-style-type: none"> <li>• Unit No. setting error</li> <li>• Broken remote control wire</li> <li>• Faulty remote control wire connection</li> <li>• Faulty outdoor unit PCB</li> </ul>

<b>5.Troubleshooting</b>	
<b>Diagnosis</b>	<b>Countermeasure</b>
<p style="text-align: center;">Note (1) Inspect faulty connections (disconnection, looseness) on the outdoor unit terminal block.</p> <p style="text-align: center;">Is the connection of signal wires at the outdoor unit side OK?</p> <p style="text-align: center;">NO → Repair signal wires.</p> <p style="text-align: center;">YES</p> <p style="text-align: center;">Note (2) Check for faulty connection or breakage of signal wires between indoor-outdoor units.</p> <p style="text-align: center;">Is the connection of signal wires between indoor-outdoor units OK?</p> <p style="text-align: center;">NO → Repair signal wires.</p> <p style="text-align: center;">YES</p> <p style="text-align: center;">Power source reset</p> <p style="text-align: center;">Has the remote control LCD returned to normal state?</p> <p style="text-align: center;">NO → Defective outdoor unit PCB (Defective network communication circuit) → Replace.</p> <p style="text-align: center;">YES → Unit is normal. (Malfunction by temporary noise, etc.)</p>	

Note:

Error code Remote control: E6	LED	Green	Red	Content <b>Indoor heat exchanger temperature sensor anomaly</b>
	Indoor	Keeps flashing	1-time flash	

**1.Applicable model**  
All models

**2.Error detection method**  
Anomalously low temperature or high temperature (resistance) is detected on the indoor heat exchanger thermistor (Thi-R1, R2 or R3).

**3.Condition of Error displayed**

- When the temperature sensor detects -50°C or lower for 5 seconds continuously, the compressor stops. After 3-minutes delay, the compressor starts again automatically, but if this error occurs again within 60 minutes after the initial detection.
- Or if 70°C or higher is detected for 5 seconds continuously.

**4.Presumable cause**

- Defective indoor heat exchanger sensor connector
- Indoor heat exchanger temperature sensor anomaly
- Faulty indoor unit control PCB

**5.Troubleshooting**

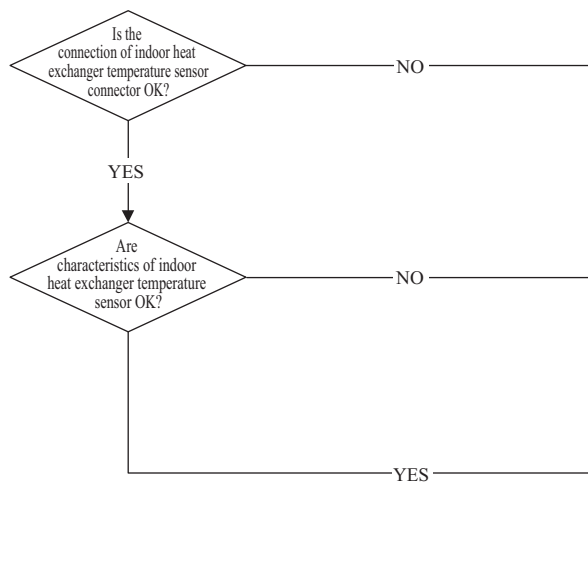
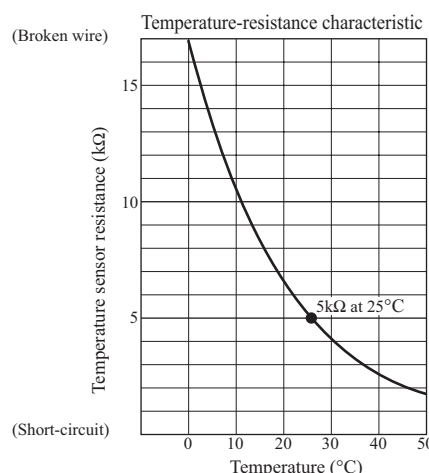
Diagnosis	Countermeasure
 <pre> graph TD     Q1{Is the connection of indoor heat exchanger temperature sensor connector OK?}     Q2{Are characteristics of indoor heat exchanger temperature sensor OK?}     C1[Correct. -&gt; Insert connector securely.]     C2[Defective indoor heat exchanger temperature sensor -&gt; Replace.]     C3[Defective indoor unit control PCB -&gt; Replace. (Defective indoor unit heat exchanger temperature sensor input circuit)]      Q1 -- NO --&gt; C1     Q1 -- YES --&gt; Q2     Q2 -- NO --&gt; C2     Q2 -- YES --&gt; C3                     </pre>	
<p>(Broken wire)</p>  <p>(Short-circuit)</p>	

Note:

Error code Remote control: E7	LED	Green	Red	Content <b>Return air temperature sensor anomaly</b>
	Indoor	Keeps flashing	1-time flash	

**1. Applicable model**  
All models

**2. Error detection method**  
Anomalously low temperature or high temperature (resistance) is detected by indoor return air temperature sensor (Thi-A)

- 3. Condition of Error displayed**
- When the temperature sensor detects  $-50^{\circ}\text{C}$  or lower for 5 seconds continuously, the compressor stops. After 3-minute delay, the compressor starts again automatically, but if this error occurs again within 60 minutes after the initial detection.
  - Or if  $48^{\circ}\text{C}$  or higher is detected for 5 seconds continuously.

- 4. Presumable cause**
- Defective return air temperature sensor connector
  - Defective return air temperature sensor
  - Faulty indoor unit control PCB

**5. Troubleshooting**

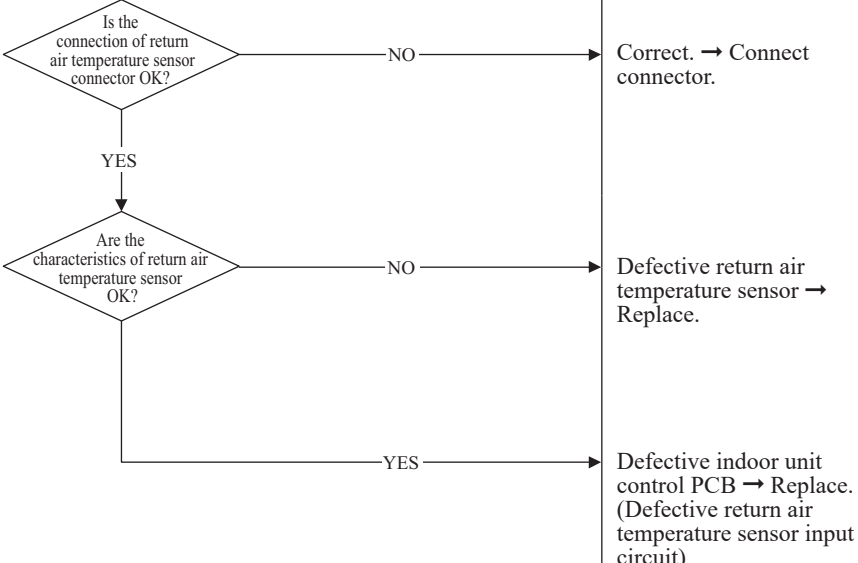
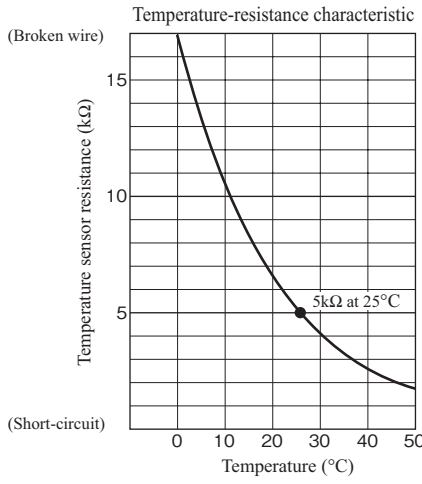
Diagnosis	Countermeasure
 <pre> graph TD     Q1{Is the connection of return air temperature sensor connector OK?}     Q2{Are the characteristics of return air temperature sensor OK?}     C1[Correct. -&gt; Connect connector.]     C2[Defective return air temperature sensor -&gt; Replace.]     C3[Defective indoor unit control PCB -&gt; Replace. (Defective return air temperature sensor input circuit)]      Q1 -- NO --&gt; C1     Q1 -- YES --&gt; Q2     Q2 -- NO --&gt; C2     Q2 -- YES --&gt; C3                     </pre>	
<p><b>Temperature-resistance characteristic</b></p>  <p>(Broken wire)</p> <p>(Short-circuit)</p>	

Note:

Error code Remote control: E8	LED	Green	Red	Content <b>Heating overload operation</b>
	Indoor	Keeps flashing	1-time flash	

<b>1.Applicable model</b>
All models
<b>2.Error detection method</b>
Indoor heat exchanger temperature sensor (Thi-R1, R2, R3)
<b>3.Condition of Error displayed</b>
When it is detected 5 times within 60 minutes from initial detection or when the overload condition is detected for 6 minutes continuously.
<b>4.Presumable cause</b>
<ul style="list-style-type: none"> <li>• Clogged air filter</li> <li>• Defective indoor heat exchanger temperature sensor connector</li> <li>• Defective indoor heat exchanger temperature sensor</li> <li>• Anomalous refrigerant system</li> </ul>

<b>5.Troubleshooting</b>	
<b>Diagnosis</b>	<b>Countermeasure</b>
<pre> graph TD     Q1{Is the air filter clogged?} -- YES --&gt; C1[Wash.]     Q1 -- NO --&gt; Q2{Is the indoor heat exchanger temperature sensor connection OK?}     Q2 -- YES --&gt; Q3{Are the characteristics of indoor heat exchanger temperature sensor OK?}     Q2 -- NO --&gt; C2[Defective indoor heat exchanger temperature sensor connector -&gt; Correct.]     Q3 -- YES --&gt; R1[Check the error data with the remote control.]     Q3 -- NO --&gt; C3[Defective indoor heat exchanger temperature sensor.]     R1 --&gt; Q4{Is the unit operating in the state of heating overload?}     Q4 -- YES --&gt; C4[Adjust]     Q4 -- NO --&gt; C5[Check refrigerant system.]     </pre> <p>Note (1) Judge if it is in the state of overload or not as follows.          ▲ Is there any short-circuit of air?          ▲ Isn't there any fouling or clogging on the indoor heat exchanger?          ▲ Is the outdoor fan control normal?          ▲ Isn't the indoor and outdoor air temperature too high?</p> <p>Note (2) For characteristics of indoor heat exchanger temperature sensor, see the error display E6.</p> <p style="text-align: center;">Indoor heat exchanger temperature (°C)</p>	

**Note:** During heating operation; After starting compressor, compressor rotation speed is decreased by detecting indoor heat exchanger temperature (Thi-R) in order to control high pressure.

Error code Remote control: E9	LED	Green	Red	Content <b>Drain trouble (FDT, FDU, FDUM series)</b>
	Indoor	Keeps flashing	1-time flash	

**1. Applicable model**  
FDT, FDU, FDUM series only

**2. Error detection method**  
Float switch is activated

**3. Condition of Error displayed**  
If the float switch OPEN is detected for 3 seconds continuously or if float switch connector or wire is disconnected.

- 4. Presumable cause**
- Defective indoor unit control or power PCB
  - Float switch setting error
  - Humidifier drain pump motor interlock setting error
  - Optional equipment setting error
  - Drain piping error
  - Defective drain pump motor
  - Disconnection of drain pump motor wiring

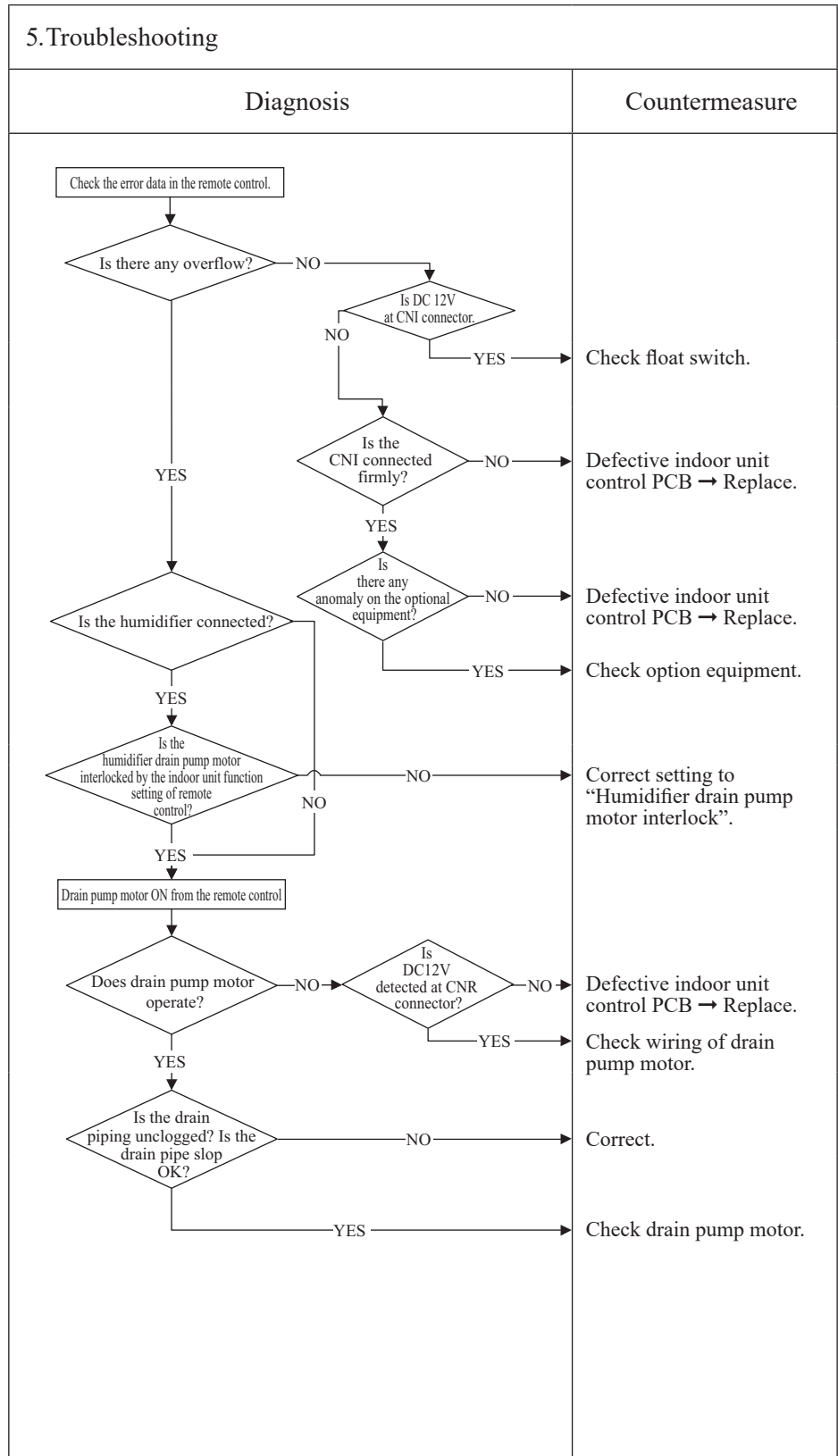

**Note:** When this error occurred at power ON, disconnection of wire or connector of the float switch is suspected. Check and correct it (or replace it, if necessary).

Error code Remote control: E10	LED	Green	Red	Content Excessive number of connected indoor units (more than 17 units) by controlling with one remote control
	Indoor	Keeps flashing	Stays OFF	

<b>1.Applicable model</b>	<b>5.Troubleshooting</b>	
All models	<b>Diagnosis</b>	<b>Countermeasure</b>
	<pre> graph LR     A{Aren't more than 17 indoor units connected to one remote control?} -- NO --&gt; B[Defective remote control -&gt; Replace.]     A -- YES --&gt; C[Reduce to 16 or less units.]             </pre>	
<b>2.Error detection method</b>		
When it detects more than 17 of indoor units connected to one remote control		
<b>3.Condition of Error displayed</b>		
Same as above		
<b>4.Presumable cause</b>		
<ul style="list-style-type: none"> <li>• Excessive number of indoor units connected</li> <li>• Defective remote control</li> </ul>		

Note:

Error code Remote control: E11	LED	Green	Red	Content <b>Address setting error of indoor units</b>
	Indoor	Keeps flashing	Keeps flashing	

<b>1. Applicable model</b>
All models

<b>2. Error detection method</b>
IU address has been set using the “Master IU address set” function of remote control.

<b>3. Condition of Error displayed</b>
Same as above

<b>4. Presumable cause</b>
Same as above

<b>5. Troubleshooting</b>	
<b>Diagnosis</b>	<b>Countermeasure</b>
<pre> graph TD     A[E11 occurs] --&gt; B{Is "Master IU address set" function of remote control used?}     B -- YES --&gt; C[Countermeasure]         </pre>	
<p>In case the wiring is below and “Mastar IU address set” is used, E11 is appeared.</p>	
<ul style="list-style-type: none"> <li>• In cases of RC-EX3A Menu → Service setting → IU settings → Select IU</li> <li>• In cases of RC-E5 Return address No. to “IU ...” using [ ▲ ] or [ ▼ ] button.</li> </ul>	

Note:



Error code Remote control: E14	LED	Green	Red	Content <b>Communication error between master and slave indoor units</b>
	Indoor	Keeps flashing	3-time flash	

<b>1.Applicable model</b>
All models

<b>2.Error detection method</b>
When communication error between master and slave indoor units occurs

<b>3.Condition of Error displayed</b>
Same as above

<b>4.Presumable cause</b>
<ul style="list-style-type: none"> <li>• Unit address setting error</li> <li>• Broken remote control wire</li> <li>• Defective remote control wire connection</li> <li>• Defective indoor unit control PCB</li> </ul>

<b>5.Troubleshooting</b>																		
<b>Diagnosis</b>	<b>Countermeasure</b>																	
<pre> graph TD     D1{Is it OK the unit address setting for master and slave indoor units?}     D2{Isn't the remote control wiring between indoor units defective?}     D3{Is it restored by resetting the power source?}          D1 -- NO --&gt; C1[Correct unit address setting.]     D1 -- YES --&gt; D2     D2 -- YES --&gt; C2[Correct wiring.]     D2 -- NO --&gt; D3     D3 -- NO --&gt; C3[Defective indoor unit control PCB -&gt; Replace.]     D3 -- YES --&gt; C4["• Malfunction by noise • Check surrounding environment."]     </pre>	<p>Defective indoor unit control PCB → Replace.</p> <ul style="list-style-type: none"> <li>• Malfunction by noise</li> <li>• Check surrounding environment.</li> </ul>																	
<p>Note (1) Set dip switches SW5-1 and SW5-2 as shown in the following table. (Factory default setting – “Master”)</p> <table border="1"> <thead> <tr> <th colspan="2" rowspan="2"></th> <th colspan="3">Indoor unit</th> </tr> <tr> <th>Master</th> <th>Slave-a</th> <th>Slave-b</th> </tr> </thead> <tbody> <tr> <th rowspan="2">DIP switch</th> <th>SW5-1</th> <td>OFF</td> <td>OFF</td> <td>ON</td> </tr> <tr> <th>SW5-2</th> <td>OFF</td> <td>ON</td> <td>OFF</td> </tr> </tbody> </table>				Indoor unit			Master	Slave-a	Slave-b	DIP switch	SW5-1	OFF	OFF	ON	SW5-2	OFF	ON	OFF
				Indoor unit														
		Master	Slave-a	Slave-b														
DIP switch	SW5-1	OFF	OFF	ON														
	SW5-2	OFF	ON	OFF														

Note:

Error code	LED	Green	Red	Content
Remote control: E16	Indoor	Keeps flashing	1(2)-time flash	Indoor fan motor anomaly

Note(1) Value in ( ) is for the FDU, FDUM series FMi2 only.

<p><b>1.Applicable model</b></p> <p>All models</p>	<p><b>5.Troubleshooting</b></p> <table border="1"> <thead> <tr> <th>Diagnosis</th> <th>Countermeasure</th> </tr> </thead> <tbody> <tr> <td> <p>Does any foreign material intervene in rotational area of fan propeller?</p> <p>NO</p> <p>Does the fan rotate smoothly when turned by hand?</p> <p>YES</p> <p>Is DC280V detected between ①-④ of fan motor connector CNM? (1)</p> <p>NO</p> <p>Is the fuse F1, 2 or F3, 4 blown?</p> <p>NO</p> <p>Power source reset</p> <p>Is it normalized?</p> </td> <td> <p>Remove foreign material.</p> <p>Replace the fan motor.</p> <p>Check power voltage.</p> <p>Replace faulty fan motor and power PCB.</p> <p>Replace fan motor. (If the error persists after replacing the fan motor, replace the indoor unit control PCB.)</p> <p>Malfunction by temporary noise</p> </td> </tr> </tbody> </table>	Diagnosis	Countermeasure	<p>Does any foreign material intervene in rotational area of fan propeller?</p> <p>NO</p> <p>Does the fan rotate smoothly when turned by hand?</p> <p>YES</p> <p>Is DC280V detected between ①-④ of fan motor connector CNM? (1)</p> <p>NO</p> <p>Is the fuse F1, 2 or F3, 4 blown?</p> <p>NO</p> <p>Power source reset</p> <p>Is it normalized?</p>	<p>Remove foreign material.</p> <p>Replace the fan motor.</p> <p>Check power voltage.</p> <p>Replace faulty fan motor and power PCB.</p> <p>Replace fan motor. (If the error persists after replacing the fan motor, replace the indoor unit control PCB.)</p> <p>Malfunction by temporary noise</p>
Diagnosis		Countermeasure			
<p>Does any foreign material intervene in rotational area of fan propeller?</p> <p>NO</p> <p>Does the fan rotate smoothly when turned by hand?</p> <p>YES</p> <p>Is DC280V detected between ①-④ of fan motor connector CNM? (1)</p> <p>NO</p> <p>Is the fuse F1, 2 or F3, 4 blown?</p> <p>NO</p> <p>Power source reset</p> <p>Is it normalized?</p>		<p>Remove foreign material.</p> <p>Replace the fan motor.</p> <p>Check power voltage.</p> <p>Replace faulty fan motor and power PCB.</p> <p>Replace fan motor. (If the error persists after replacing the fan motor, replace the indoor unit control PCB.)</p> <p>Malfunction by temporary noise</p>			
<p><b>2.Error detection method</b></p> <p>Detected by rotation speed of indoor fan motor</p>					
<p><b>3.Condition of Error displayed</b></p> <p>When actual rotation speed of indoor fan motor drops to lower than <math>200\text{min}^{-1}</math> for 30 seconds continuously, the compressor and the indoor fan motor stop. After 2-seconds, it starts again automatically, but if this error occurs 4 times within 60 minutes after the initial detection.</p>					
<p><b>4.Presumable cause</b></p> <ul style="list-style-type: none"> <li>• Defective indoor unit power PCB</li> <li>• Foreign material at rotational area of fan propeller</li> <li>• Defective fan motor</li> <li>• Dust on control PCB</li> <li>• Blown fuse</li> <li>• External noise, surge</li> </ul>					

Note:

Error code Remote control: E18	LED	Green	Red	Content <b>Address setting error of master and slave indoor units</b>
	Indoor	Keeps flashing	1-time flash	

<b>1.Applicable model</b>
All models

<b>2.Error detection method</b>
IU address has been set using the “Master IU address set” function of remote control.

<b>3.Condition of Error displayed</b>
Same as above

<b>4.Presumable cause</b>
Same as above

<b>5.Troubleshooting</b>	
<b>Diagnosis</b>	<b>Countermeasure</b>
<pre> graph TD     A[E18 occurs] --&gt; B{Is "Master IU address set" function of remote control used?}     B -- YES --&gt; C[Countermeasure]             </pre>	
	<ul style="list-style-type: none"> <li>• In cases of RC-EX3A Menu → Service setting → IU settings → Select IU</li> <li>• In cases of RC-E5 Return address No. to “IU ...” using [ ▲ ] or [ ▼ ] button.</li> </ul>

Note:

Error code Remote control: E19	LED	Green	Red	Content <b>Indoor unit operation check, drain pump motor check setting error</b>
	Indoor	Keeps flashing	1-time flash	

<b>1.Applicable model</b>	<b>5.Troubleshooting</b>		
All models	<b>Diagnosis</b>	<b>Countermeasure</b>	
<b>2.Error detection method</b>	<pre> graph TD     Start[E19 occurs when the power ON] --&gt; Decision{Is SW7-1 on the indoor unit control PCB ON?}     Decision -- YES --&gt; Countermeasure1[Turn SW7-1 on the indoor unit control PCB OFF and reset the power.]     Decision -- NO --&gt; Countermeasure2[Defective indoor unit control PCB (Defective SW7) -&gt; Replace.]             </pre>		
After indoor operation check, when the communication between indoor and outdoor unit is established and SW7-1 is still kept ON.			
<b>3.Condition of Error displayed</b>	Same as above		
<b>4.Presumable cause</b>	Mistake in SW7-1 setting (Due to forgetting to turn OFF SW7-1 after indoor operation check)		

Note:

Error code Remote control: E20	LED	Green	Red	Content <b>Indoor fan motor rotation speed anomaly</b>
	Indoor	Keeps flashing	1(2)-time flash	

Note(1) Value in ( ) is for the FDU, FDUM series FMi2 only.

<p><b>1.Applicable model</b></p> <p>All models</p>	<b>5.Troubleshooting</b>	
<p><b>2.Error detection method</b></p> <p>Detected by rotation speed of indoor fan motor</p>	<b>Diagnosis</b>	<b>Countermeasure</b>
<p><b>3.Condition of Error displayed</b></p> <p>When the actual fan rotation speed does not reach to the speed of [required speed -50 (FDU:-500) min<sup>-1</sup>] after 2 minutes have been elapsed since the fan motor rotation speed command was output, the unit stops by detecting indoor fan motor anomaly.</p>	<pre> graph TD     Q1{Does any foreign material intervene in rotational area of fan propeller?} -- YES --&gt; C1[Remove foreign material.]     Q1 -- NO --&gt; Q2{Does the fan rotate smoothly when turned by hand?}     Q2 -- YES --&gt; Q3{Is DC280V detected between ①-④ of fan motor connector CNM?}     Q2 -- NO --&gt; C2[Replace the fan motor.]     Q3 -- YES --&gt; Q4{Is the fuse F1, 2 or F3, 4 blown?}     Q3 -- NO --&gt; C3[Check power voltage.]     Q4 -- YES --&gt; C4[Replace faulty fan motor and power PCB.]     Q4 -- NO --&gt; C3     Q3 --&gt; R[Power source reset]     R --&gt; Q5{Is it normalized?}     Q5 -- YES --&gt; C5[Malfunction by temporary noise]     Q5 -- NO --&gt; C6[Replace fan motor. (If the error persists after replacing the fan motor, replace the indoor unit control PCB.)]     </pre>	
<p><b>4.Presumable cause</b></p> <ul style="list-style-type: none"> <li>• Defective indoor unit power PCB</li> <li>• Foreign material at rotational area of fan propeller</li> <li>• Defective fan motor</li> <li>• Dust on indoor unit control PCB</li> <li>• Blown fuse</li> <li>• External noise, surge</li> </ul>		

Note:

Error code Remote control: E28	LED	Green	Red	Content <b>Remote control temperature sensor anomaly</b>
	Indoor	Keeps flashing	Stays OFF	

**1. Applicable model**  
All models

**2. Error detection method**  
Detection of anomalously low temperature (resistance) of remote control temperature sensor (Thc)

**3. Condition of Error displayed**  
When the temperature sensor detects -50°C or lower for 5 seconds continuously, the compressor stops. After 3-minute delay, the compressor starts again automatically, but if this error occurs again within 60 minutes after the initial detection.

**4. Presumable cause**

- Faulty connection of remote control temperature sensor
- Defective remote control temperature sensor
- Defective remote control PCB

**5. Troubleshooting**

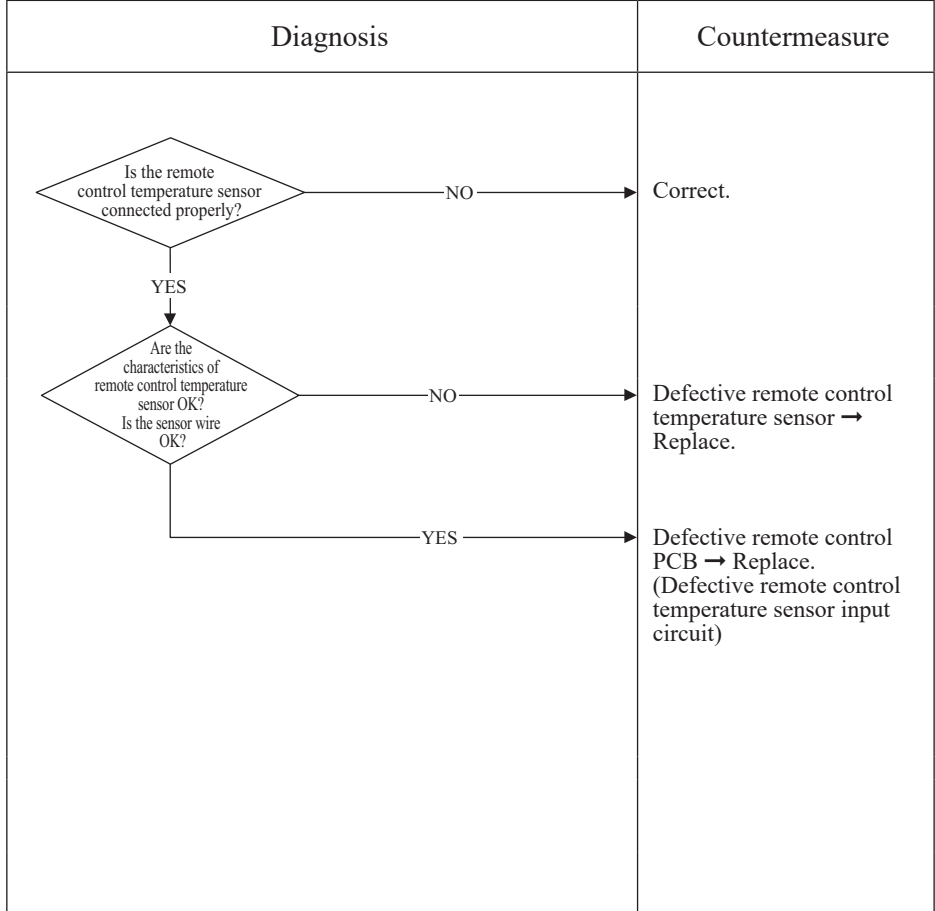

Resistance-temperature characteristics of remote control temperature sensor (Thc)

Temperature (°C)	Resistance value (kΩ)	Temperature (°C)	Resistance value (kΩ)
0	65	30	16
1	62	32	15
2	59	34	14
4	53	36	13
6	48	38	12
8	44	40	11
10	40	42	9.9
12	36	44	9.2
14	33	46	8.5
16	30	48	7.8
18	27	50	7.3
20	25	52	6.7
22	23	54	6.3
24	21	56	5.8
26	19	58	5.4
28	18	60	5.0

**Note:** After 10 seconds has passed since remote control sensor was switched from valid to invalid, E28 will not be displayed even if the sensor harness is disconnected. At same time the temperature sensor, which is effective, is switched from remote control sensor to indoor return air temperature sensor. Even though the remote control sensor is set to be Effective, the return air temperature displayed on remote control for checking still shows the value detected by indoor return air temperature sensor, not by remote control temperature sensor.

<table border="1"> <tr> <td>Error code</td> <td>LED</td> <td>Green</td> <td>Red</td> <td>Content</td> </tr> <tr> <td>Remote control: E35</td> <td>Indoor</td> <td>Keeps flashing</td> <td>Stays OFF</td> <td rowspan="2">Cooling overload operation</td> </tr> </table>	Error code	LED	Green	Red	Content	Remote control: E35	Indoor	Keeps flashing	Stays OFF	Cooling overload operation
Error code	LED	Green	Red	Content						
Remote control: E35	Indoor	Keeps flashing	Stays OFF	Cooling overload operation						

1.Applicable model
All models

2.Error detection method
<p>Outdoor heat exchanger temperature (°C)</p> <p>Note (1) Values in ( ) are applicable when outdoor temperature (TH2) is lower than 32 °C</p>

3.Condition of Error displayed
When anomalous outdoor heat exchanger temperature occurs 5 times within 60 minutes or 60(56)°C or higher continues for 10 minutes, including the compressor stop.

4.Presumable cause
<ul style="list-style-type: none"> <li>• Defective outdoor heat exchanger temperature sensor</li> <li>• Defective outdoor unit PCB</li> <li>• Indoor, outdoor unit installation spaces</li> <li>• Short-circuit of air on indoor, outdoor units</li> <li>• Fouling, clogging of heat exchanger</li> <li>• Excessive refrigerant quantity</li> </ul>

5.Troubleshooting						
<table border="1"> <thead> <tr> <th>Diagnosis</th> <th>Countermeasure</th> </tr> </thead> <tbody> <tr> <td> <p>* For the characteristics of outdoor heat exchanger temperature sensor, refer to E37.</p> <pre> graph TD     Q1{Are normal the characteristics of outdoor heat exchanger temperature sensor normal?}     Q2{Is the unit operating in the state of cooling overload?}     Q3{Is the high pressure control normal?}     Q4{Is the temperature (measured actually) at direction of error correct?}          Q1 -- NO --&gt; C1[Replace outdoor heat exchanger temperature sensor.]     Q1 -- YES --&gt; Q2     Q2 -- YES --&gt; C2[Check unit side. &lt;br/&gt;• Isn't the air circulation of outdoor unit short-circuited? &lt;br/&gt;• Are installation spaces adequate? &lt;br/&gt;• Isn't there any fouling or clogging on heat exchanger?]     Q2 -- NO --&gt; Q3     Q3 -- NO --&gt; C3[Control operation check*]     Q3 -- YES --&gt; Q4     Q4 -- NO --&gt; C4[Defective outdoor unit PCB→Replace.]     Q4 -- YES --&gt; C5[Excessive refrigerant amount: Recharge refrigerant by weighing proper amount on a scale.]                     </pre> </td> <td></td> </tr> <tr> <td> <p>* For the contents of control, refer to the protective control by controlling compressor rotation speed and cooling high pressure protective control of microcomputer control function for corresponding models.</p> </td> <td></td> </tr> </tbody> </table>	Diagnosis	Countermeasure	<p>* For the characteristics of outdoor heat exchanger temperature sensor, refer to E37.</p> <pre> graph TD     Q1{Are normal the characteristics of outdoor heat exchanger temperature sensor normal?}     Q2{Is the unit operating in the state of cooling overload?}     Q3{Is the high pressure control normal?}     Q4{Is the temperature (measured actually) at direction of error correct?}          Q1 -- NO --&gt; C1[Replace outdoor heat exchanger temperature sensor.]     Q1 -- YES --&gt; Q2     Q2 -- YES --&gt; C2[Check unit side. &lt;br/&gt;• Isn't the air circulation of outdoor unit short-circuited? &lt;br/&gt;• Are installation spaces adequate? &lt;br/&gt;• Isn't there any fouling or clogging on heat exchanger?]     Q2 -- NO --&gt; Q3     Q3 -- NO --&gt; C3[Control operation check*]     Q3 -- YES --&gt; Q4     Q4 -- NO --&gt; C4[Defective outdoor unit PCB→Replace.]     Q4 -- YES --&gt; C5[Excessive refrigerant amount: Recharge refrigerant by weighing proper amount on a scale.]                     </pre>		<p>* For the contents of control, refer to the protective control by controlling compressor rotation speed and cooling high pressure protective control of microcomputer control function for corresponding models.</p>	
Diagnosis	Countermeasure					
<p>* For the characteristics of outdoor heat exchanger temperature sensor, refer to E37.</p> <pre> graph TD     Q1{Are normal the characteristics of outdoor heat exchanger temperature sensor normal?}     Q2{Is the unit operating in the state of cooling overload?}     Q3{Is the high pressure control normal?}     Q4{Is the temperature (measured actually) at direction of error correct?}          Q1 -- NO --&gt; C1[Replace outdoor heat exchanger temperature sensor.]     Q1 -- YES --&gt; Q2     Q2 -- YES --&gt; C2[Check unit side. &lt;br/&gt;• Isn't the air circulation of outdoor unit short-circuited? &lt;br/&gt;• Are installation spaces adequate? &lt;br/&gt;• Isn't there any fouling or clogging on heat exchanger?]     Q2 -- NO --&gt; Q3     Q3 -- NO --&gt; C3[Control operation check*]     Q3 -- YES --&gt; Q4     Q4 -- NO --&gt; C4[Defective outdoor unit PCB→Replace.]     Q4 -- YES --&gt; C5[Excessive refrigerant amount: Recharge refrigerant by weighing proper amount on a scale.]                     </pre>						
<p>* For the contents of control, refer to the protective control by controlling compressor rotation speed and cooling high pressure protective control of microcomputer control function for corresponding models.</p>						

Note:

Error code Remote control: E36	LED	Green	Red	Content <b>Discharge pipe temperature error</b>
	Indoor	Keeps flashing	Stays OFF	

<b>1.Applicable model</b>
All models
<b>2.Error detection method</b>
For the error detection method, refer to the protective control by controlling compressor rotation speed and cooling high pressure protective control of micro-computer control function for corresponding models.
<b>3.Condition of Error displayed</b>
When discharge pipe temperature anomaly is detected 2 times within 60 minutes is compressor stop.
<b>4.Presumable cause</b>
<ul style="list-style-type: none"> <li>• Defective outdoor unit PCB</li> <li>• Defective discharge pipe temperature sensor</li> <li>• Clogged filter</li> <li>• Indoor, outdoor unit installation spaces</li> <li>• Short-circuit of air on indoor, outdoor units</li> <li>• Fouling, clogging of heat exchanger</li> </ul>

<b>5.Troubleshooting</b>	
<b>Diagnosis</b>	<b>Countermeasure</b>
<p style="text-align: right;">* For the characteristics of discharge pipe temperature, refer to E39.</p> <pre> graph TD     D1{Are the characteristics of discharge pipe temperature sensor normal?} -- NO --&gt; C1[Replace discharge pipe temperature sensor.]     D1 -- YES --&gt; D2{Is the discharge pipe temperature error persisted during cooling operation?}     D2 -- YES --&gt; C2[Insufficient refrigerant amount : Recharge refrigerant by weighing proper amount on a scale.]     D2 -- NO --&gt; D3{Is the discharge pipe temperature control normal?}     D3 -- NO --&gt; C3[Control operation check *]     D3 -- YES --&gt; D4{Is the temperature (measured actually) at detection of error correct?}     D4 -- NO --&gt; C4[Defective outdoor unit PCB → Replace.]     D4 -- YES --&gt; C5[Check unit side: • Isn't filter clogged? • Are adequate indoor, outdoor unit installation spaces? • Isn't there any short-circuit of air? • Isn't there any fouling, clogging on indoor heat exchanger?]     </pre> <p style="text-align: center;">* For the contents of control, refer to the protective control by controlling compressor rotation speed and cooling high pressure protective control of microcomputer control function for corresponding models.</p>	

Note:



Error code Remote control: E37	LED	Green	Red	Content <b>Outdoor heat exchanger temperature sensor anomaly</b>
	Indoor	Keeps flashing	Stays OFF	

**1. Applicable model**  
All models

**2. Error detection method**  
Detection of anomalously low temperature (resistance) on the outdoor heat exchanger temperature sensor

**3. Condition of Error displayed**

- When the temperature sensor detects -55 °C or lower for 20 seconds continuously within 2 minutes to 2 minutes 20 seconds after the compressor ON, the compressor stops. After 3-minutes delay, the compressor starts again automatically, but if this anomalous temperature is detected 3 times within 40 minutes.
- When -55 °C or lower is detected for 5 seconds continuously within 20 seconds after power ON.

**4. Presumable cause**

- Defective outdoor unit PCB
- Broken sensor harness or temperature sensing section
- Disconnected wire connection (connector)

**5. Troubleshooting**

Diagnosis	Countermeasure
<p>Is the outdoor heat exchanger temperature sensor connector connected properly?</p> <p>NO →</p> <p>YES →</p> <p>For the characteristics of outdoor heat exchanger temperature sensor, see the following graph.</p> <p>Are the characteristics of outdoor heat exchanger temperature sensor OK?</p> <p>NO →</p> <p>YES →</p>	<p>Correct connector.</p> <p>Defective outdoor heat exchanger temperature sensor → Replace.</p> <p>Defective outdoor unit PCB → Replace. (Defective outdoor heat exchanger temperature sensor input circuit)</p>
<p>Temperature-resistance characteristics</p> <p>(Broken wire)</p> <p>(Short-circuit)</p>	

Note:

Error code Remote control: E38	LED	Green	Red	Content <b>Outdoor air temperature sensor anomaly</b>
	Indoor	Keeps flashing	Stays OFF	

**1.Applicable model**  
All models

**2.Error detection method**  
Detection of anomalously low temperature (resistance) on outdoor air temperature sensor

**3.Condition of Error displayed**

- When the temperature sensor detects -55 °C or lower for 5 seconds continuously within 2 minutes to 2 minutes 20 seconds after the compressor ON, the compressor stops. After 3-minutes delay, the compressor starts again automatically, but if this anomalous temperature is detected 3 times within 40 minutes.
- When -55 °C or lower is detected for 5 seconds continuously within 20 seconds safter power ON.

**4.Presumable cause**

- Defective outdoor unit PCB
- Broken sensor harness or temperature sensing section (Check molding.)
- Disconnected wire connection (connector)

**5.Troubleshooting**

Diagnosis	Countermeasure
	<p>Correct connector.</p> <p>Defective outdoor air temperature sensor → Replace.</p> <p>Defective outdoor unit PCB → Replace. (Defective outdoor air temperature sensor input circuit)</p>

**Temperature-resistance characteristics**

(Broken wire)

(Short-circuit)

Note:

Error code Remote control: E39	LED	Green	Red	Content <b>Discharge pipe temperature sensor anomaly</b>
	Indoor	Keeps flashing	Stays OFF	

<b>1.Applicable model</b>
All models

<b>2.Error detection method</b>
Detection of anomalously low temperature (resistance) on the discharge pipe temperature sensor

<b>3.Condition of Error displayed</b>
When the temperature sensor detects -25 °C or lower for 5 seconds continuously within 10 minutes to 10 minutes 20 seconds after the compressor ON, the compressor stops. After 3-minute delay, the compressor starts again automatically, but if this anomalous temperature is detected 3 times within 40 minutes.

<b>4.Presumable cause</b>
<ul style="list-style-type: none"> <li>• Defective outdoor unit PCB</li> <li>• Broken sensor harness or temperature sensing section (Check molding.)</li> <li>• Disconnected wire connection (connector)</li> </ul>

<b>5.Troubleshooting</b>																			
<b>Diagnosis</b>	<b>Countermeasure</b>																		
<p>(Broken wire) Temperature-resistance characteristics</p> <table border="1"> <caption>Approximate data from Temperature-resistance characteristics graph</caption> <thead> <tr> <th>Temperature (°C)</th> <th>Temperature sensor resistance (kΩ)</th> </tr> </thead> <tbody> <tr><td>0</td><td>100</td></tr> <tr><td>20</td><td>60</td></tr> <tr><td>40</td><td>35</td></tr> <tr><td>60</td><td>20</td></tr> <tr><td>80</td><td>12</td></tr> <tr><td>100</td><td>8</td></tr> <tr><td>120</td><td>5</td></tr> <tr><td>140</td><td>3</td></tr> </tbody> </table>		Temperature (°C)	Temperature sensor resistance (kΩ)	0	100	20	60	40	35	60	20	80	12	100	8	120	5	140	3
Temperature (°C)	Temperature sensor resistance (kΩ)																		
0	100																		
20	60																		
40	35																		
60	20																		
80	12																		
100	8																		
120	5																		
140	3																		
<p>Correct connector.</p> <p>Defective discharge pipe temperature sensor → Replace.</p> <p>Defective outdoor unit PCB → Replace. (Defective temperature sensor input circuit)</p>																			

Note:

Error code Remote control: E40	LED	Green	Red	Content Service valve (gas side) closing operation
	Indoor	Keeps flashing	Stays OFF	

<b>1.Applicable model</b>
All models

<b>2.Error detection method</b>
If the inverter output current value exceeds the setting value within 80 seconds after the compressor ON in the heating mode, the compressor stops.

<b>3.Condition of Error displayed</b>
<ul style="list-style-type: none"> <li>• If the output current of inveter exceeds the specifications, it makes the compressor stopping. (In heating mode)</li> <li>• After 3-minute delay, the compressor restarts, but if this anomaly occurs 2 times within 20 minutes after the intial detection.</li> </ul>

<b>4.Presumable cause</b>
<ul style="list-style-type: none"> <li>• Service valve (gas side) closing</li> <li>• Defective outdoor unit PCB</li> </ul>

<b>5.Troubleshooting</b>	
<b>Diagnosis</b>	<b>Countermeasure</b>
<pre> graph TD     Q1{Are the service valve (gas side) opened?} -- NO --&gt; C1[Open the service valve.]     Q1 -- YES --&gt; Q2{Is the checked result of power transistor module OK?}     Q2 -- NO --&gt; C2[Defective outdoor unit PCB -&gt; Replace.]     Q2 -- YES --&gt; D1[Is the space for installation of indoor and/or outdoor unit enough? Is there any short-circuit of air on indoor and/or outdoor unit? At heating, does the indoor fan motor run? Is the filter clogged? Is there any liquid flooding? Is there any anomalous sound on the compressor?]     D1 --&gt; Q3{After resetting power for several times does it become normal?}     Q3 -- NO --&gt; C3[Defective outdoor unit PCB -&gt; Replace.]     Q3 -- YES --&gt; C4[Temporary noise may cause of anomaly. If noise source can be found, take countermeasure.]     </pre>	

Note:

Error code Remote control: E42	LED	Green	Red	Content <b>Current cut (1/2)</b>
	Indoor	Keeps flashing	Stays OFF	

<b>1.Applicable model</b>
All models

<b>2.Error detection method</b>
In order to prevent from overcurrent of inverter, if the current exceeds the specifications, it makes the compressor stopping.

<b>3.Condition of Error displayed</b>
<ul style="list-style-type: none"> <li>• If the output current of inverter exceeds the specifications, it makes the compressor stopping.</li> </ul>

<b>4.Presumable cause</b>
<ul style="list-style-type: none"> <li>• The valves closed</li> <li>• Faulty power source</li> <li>• Insufficient refrigerant amount</li> <li>• Faulty compressor</li> <li>• Faulty power transistor module</li> </ul>

<b>5.Troubleshooting</b>	
<b>Diagnosis</b>	<b>Countermeasure</b>
<pre> graph TD     A{Is the power source voltage OK?} -- NO --&gt; B[Check power source.]     A -- YES --&gt; C{Are the service valves opened?}     C -- NO --&gt; D[Open the service valves.]     C -- YES --&gt; E{Is the high pressure during operation OK?}     E -- NO --&gt; F[Check refrigerant amount and refrigerant circuit. *In case of transitional increase of high pressure and/or test run, several times restarting may recover it, because liquid refrigerant (migrated) in the compressor is discharged from the compressor.]     E -- YES --&gt; G{Is the checked result of insulation resistance and resistance between terminals (1) of compressor motor OK? (1) 0.724Ω or more at 20°C (Model FDC90, 100)}     G -- NO --&gt; H[Replace compressor.]     G -- YES --&gt; I[To next page.]     </pre>	

Note:

Error code Remote control: E42	LED	Green	Red	Content <b>Current cut (2/2)</b>
	Indoor	Keeps flashing	Stays OFF	

**1.Applicable model**  
All models

**2.Error detection method**  
In order to prevent from overcurrent of inverter, if the current exceeds the specifications, it makes the compressor stopping.

**3.Condition of Error displayed**  
• If the output current of inveter exceeds the specifications, it makes the compressor stopping.

**4.Presumable cause**

- Defective outdoor unit PCB
- Faulty power source
- Insufficient refrigerant amount
- Faulty compressor
- Faulty power transistor module

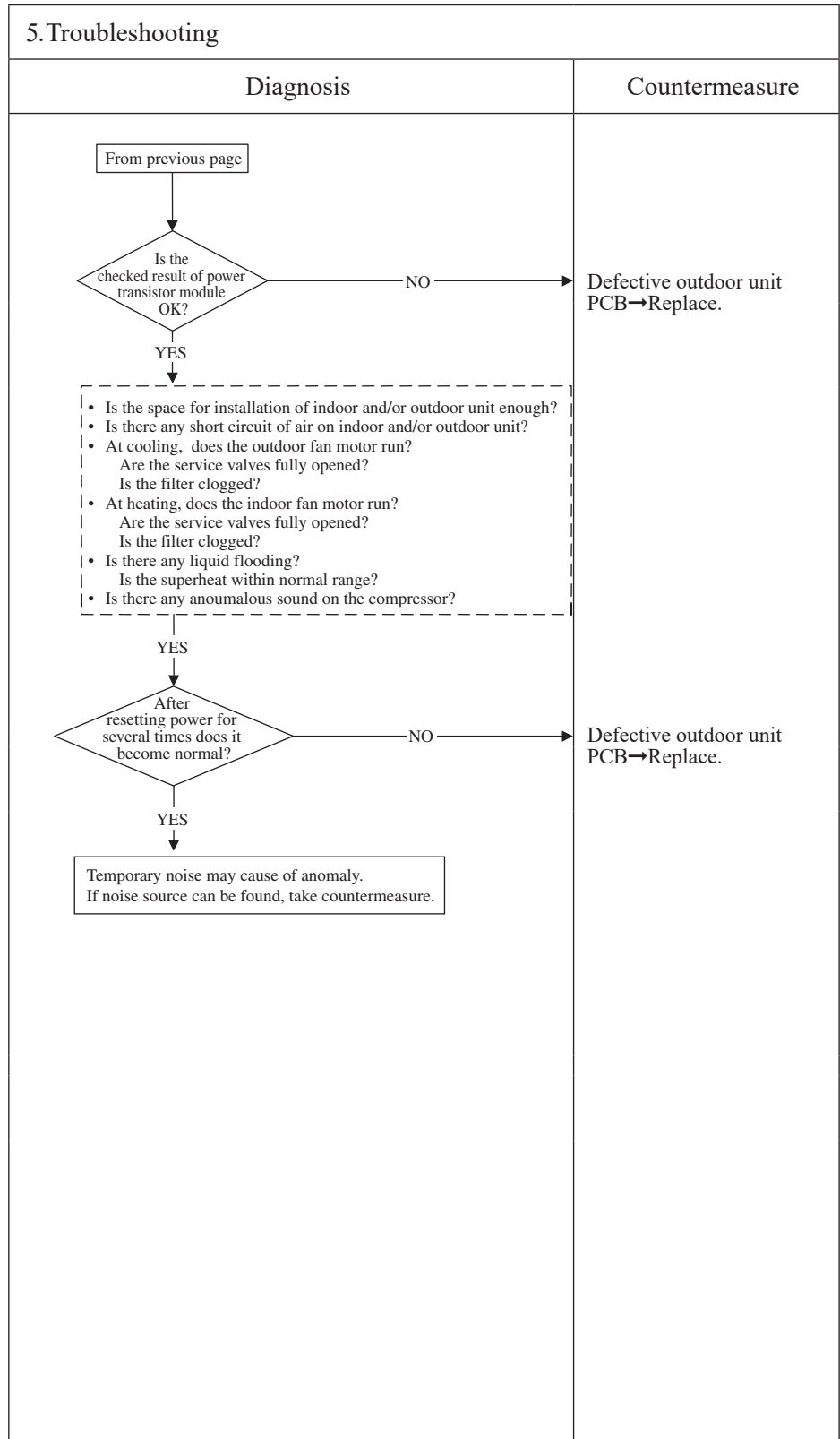

Note:

Error code Remote control: E47	LED	Green	Red	Content <b>Active filter voltage error</b>
	Indoor	Keeps flashing	Stays OFF	

<b>1.Applicable model</b>
All models

<b>2.Error detection method</b>
Error is displayed if the converter voltage exceeds target voltage (3 times within 20 minutes). Remote control may be set after 3-minute delay. Error is displayed if the converter voltage is lower than 210V (1-time within 5 seconds after power ON)

<b>3.Condition of Error displayed</b>
Same as above

<b>4.Presumable cause</b>
<ul style="list-style-type: none"> <li>• Defective outdoor unit PCB</li> <li>• Dust on outdoor unit PCB</li> <li>• Anomalous power source</li> </ul>

<b>5.Troubleshooting</b>	
<b>Diagnosis</b>	<b>Countermeasure</b>
<pre> graph TD     A{Is the power source normal?} -- NO --&gt; B[Restore normal condition.]     A -- YES --&gt; C{Is voltage within the specified range?}     C -- NO --&gt; D[Restore normal condition.]     C -- YES --&gt; E{Check soldered surfaces on the outdoor unit PCB for foreign matter like dust, fouling, etc.}     E -- NO --&gt; F[Remove foreign matter like dust, fouling, etc.]     E -- YES --&gt; G[Defective outdoor unit PCB -&gt; Replace.]     </pre>	

<b>Note:</b>
--------------

Error code Remote control: E48	LED	Green	Red	Content <b>Outdoor fan motor anomaly</b>
	Indoor	Keeps flashing	Stays OFF	

<b>1.Applicable model</b>
All models

<b>2.Error detection method</b>
Detected by rotation speed of outdoor fan motor

<b>3.Condition of Error displayed</b>
When actual rotation speed of outdoor fan motor drops to 75min <sup>-1</sup> or lower for 30 minutes continuously, the compressor and the outdoor fan motor stop. After 3-minute delay, it starts again automatically, but if this anomaly occurs 3 times within 60 minutes after the initial detection.

<b>4.Presumable cause</b>
<ul style="list-style-type: none"> <li>• Defective outdoor unit PCB</li> <li>• Foreign material at rotational area of fan propeller</li> <li>• Defective fan motor</li> <li>• Dust on outdoor unit PCB</li> <li>• Blown F3 fuse</li> </ul>

<b>5.Troubleshooting</b>	
<b>Diagnosis</b>	<b>Countermeasure</b>
<pre> graph TD     D1{Does any foreign material intervene in rotational area of fan propeller?} -- YES --&gt; C1[Remove foreign matter.]     D1 -- NO --&gt; D2{Does the fan rotate smoothly when turned by hand?}     D2 -- YES --&gt; D3{Is DC308-336V detected between (CNFAN ④ -⑥) of fan motor connector?}     D2 -- NO --&gt; C2[Replace fan motor. If resistance between ① (FG):blue -④(GND):black is detected 1kΩ or lower, it is faulty.]     D3 -- YES --&gt; R[Power source reset]     D3 -- NO --&gt; D4{Is F3 (250V1A) fuse blown?}     R --&gt; D5{Is normal state restored?}     D4 -- YES --&gt; C3[Replace faulty fan motor and outdoor unit PCB.]     D4 -- NO --&gt; C4[Check power source voltage.]     D5 -- YES --&gt; C5[Malfunction by temporary noise]     D5 -- NO --&gt; C6[Replace fan motor (If anomaly persists after replacing fan motor, replace outdoor unit PCB.)]     </pre>	

Note: When E48 error occurs, in almost cases F3 fuse (1A) on the outdoor unit PCB is blown. There are a lot of cases that fuse is blown and E48 occurs due to defective fan motor. And even though only the outdoor unit PCB ( or fuse) is replaced,, another trouble could occur. Therefore when fuse is blown, check whether the fan motor is OK or not. After confirming the fan motor normal, check by power ON. (Don't power ON without confirming the fan motor normal.)



Error code Remote control: E51	LED	Green	Red	Content <b>Power transistor anomaly</b>
	Indoor	Keeps flashing	Stays OFF	

<p><b>1.Applicable model</b></p> <p>All models</p>	<b>5.Troubleshooting</b>		
<p><b>2.Error detection method</b></p> <p>Power transistor primary current</p>	<b>Diagnosis</b>	<b>Countermeasure</b>	
<p><b>3.Condition of Error displayed</b></p> <p>If the power transistor primary current exceeds the setting value for 3 seconds, the compressor stops.</p>	<pre> graph TD     A{Check soldered surfaces on the outdoor unit PCB for foreign matter like dust, fouling, etc.} -- NO --&gt; B[Remove foreign matter like dust, fouling, etc.]     A -- YES --&gt; C{Isn't F2 fuse (250V, 20A) blown?}     C -- YES --&gt; D[Replace fuse.]     C -- NO --&gt; E[Defective outdoor unit PCB -&gt; Replace.]             </pre>		<p>Remove foreign matter like dust, fouling, etc.</p> <p>Replace fuse.</p> <p>Defective outdoor unit PCB→Replace.</p>
<p><b>4.Presumable cause</b></p> <ul style="list-style-type: none"> <li>• Faulty outdoor unit PCB</li> <li>• Dust on outdoor unit PCB</li> <li>• Blown F2 fuse</li> </ul>			

Note:

Error code Remote control: E57	LED	Green	Red	Content <b>Insufficient refrigerant amount or detection of service valve closure</b>
	Indoor	Keeps flashing	Stays OFF	

<b>1. Applicable model</b>
All models
<b>2. Error detection method</b>
<ul style="list-style-type: none"> <li>Judge insufficient refrigerant amount by detecting the temperature difference between indoor heat exchanger (Thi-R) and indoor return air (Thi-A).</li> </ul>
<b>3. Condition of Error displayed</b>
When the insufficient refrigerant amount is detected 3 times within 60 minutes.
<b>4. Presumable cause</b>
<ul style="list-style-type: none"> <li>Defective indoor heat exchanger temperature sensor</li> <li>Defective indoor return air temperature sensor</li> <li>Defective indoor unit control PCB</li> <li>Insufficient refrigerant amount</li> </ul>

<b>5. Troubleshooting</b>																	
<b>Diagnosis</b>	<b>Countermeasure</b>																
<pre> graph TD     Q1{Is the service valve fully opened?} -- NO --&gt; C1[Open fully.]     Q1 -- YES --&gt; Q2{Are the connections of indoor heat exchanger and/or return air temperature sensor connectors OK?}     Q2 -- NO --&gt; C2[Correct indoor heat exchanger, return air temperature sensor connector connections.]     Q2 -- YES --&gt; Q3{Are the characteristics of indoor heat exchanger and/or return air temperature sensor OK?}     Q3 -- NO --&gt; C3[Defective indoor heat exchanger, return air temperature sensor -&gt; Replace.]     Q3 -- YES --&gt; Q4{Is the low pressure during operation normal?}     Q4 -- NO --&gt; C4[Charge refrigerant.]     Q4 -- YES --&gt; C5[Defective indoor unit control PCB -&gt; Replace. (Defective indoor heat exchanger, return air temperature sensor input circuits)]     </pre>																	
<p style="text-align: center;">Indoor heat exchanger, return air temperature sensor Temperature-resistance characteristics</p> <table border="1"> <caption>Temperature-resistance characteristics (Approximate values from graph)</caption> <thead> <tr> <th>Temperature (°C)</th> <th>Temperature sensor resistance (kΩ)</th> </tr> </thead> <tbody> <tr> <td>0</td> <td>15</td> </tr> <tr> <td>10</td> <td>10</td> </tr> <tr> <td>20</td> <td>6</td> </tr> <tr> <td>25</td> <td>5</td> </tr> <tr> <td>30</td> <td>4</td> </tr> <tr> <td>40</td> <td>3</td> </tr> <tr> <td>50</td> <td>2</td> </tr> </tbody> </table>		Temperature (°C)	Temperature sensor resistance (kΩ)	0	15	10	10	20	6	25	5	30	4	40	3	50	2
Temperature (°C)	Temperature sensor resistance (kΩ)																
0	15																
10	10																
20	6																
25	5																
30	4																
40	3																
50	2																

Note: When the compressor speed is 50 rps or under at 5 minutes after the start of compressor or the completion of defrost operation, the low refrigerant protection control judges, by detecting the difference between the indoor heat exchanger temperature (Thi-R) and the indoor return air temperature (Thi-A), that it is in the state of gas leakage, and stops the compressor.  
Cooling: Indoor return air temperature (Thi-A) – Indoor heat exchanger temperature (Thi-R) < 4 deg C  
Heating: Indoor heat exchanger temperature (Thi-R) – Indoor return air temperature (Thi-A) < 6 deg C

Error code Remote control: E58	LED	Green	Red	Content <b>Current safe stop</b>
	Indoor	Keeps flashing	Stays OFF	

<b>1.Applicable model</b>
All models

<b>2.Error detection method</b>
When the current safe control has operated at the compressor speed of 30 rps or under.

<b>3.Condition of Error displayed</b>
Same as above

<b>4.Presumable cause</b>
<ul style="list-style-type: none"> <li>• Excessive refrigerant amount</li> <li>• Indoor, outdoor unit installation spaces</li> <li>• Faulty compressor</li> <li>• Defective outdoor air temperature sensor</li> <li>• Defective outdoor unit PCB</li> </ul>

<b>5.Troubleshooting</b>	
<b>Diagnosis</b>	<b>Countermeasure</b>
<pre> graph TD     D1{Is the refrigerant amount normal?} -- NO --&gt; C1[Adjust the refrigerant amount properly.]     D1 -- YES --&gt; D2{Is outdoor ventilation condition good?}     D2 -- NO --&gt; C2[Secure space for inlet and outlet.]     D2 -- YES --&gt; D3{Inspect compressor.}     D3 -- NO --&gt; C3[Replace compressor.]     D3 -- YES --&gt; D4{Inspect outdoor air temperature sensor.}     D4 -- NO --&gt; C4[Replace sensor.]     D4 -- YES --&gt; C5[Defective outdoor unit PCB -&gt; Replace. (Defective outdoor air temperature sensor input circuit)]             </pre>	

Note:

<table border="1"> <tr> <td>Error code</td> <td>LED</td> <td>Green</td> <td>Red</td> <td>Content</td> </tr> <tr> <td>Remote control: E59</td> <td>Indoor</td> <td>Keeps flashing</td> <td>Stays OFF</td> <td rowspan="2">Compressor startup failure</td> </tr> </table>	Error code	LED	Green	Red	Content	Remote control: E59	Indoor	Keeps flashing	Stays OFF	Compressor startup failure
Error code	LED	Green	Red	Content						
Remote control: E59	Indoor	Keeps flashing	Stays OFF	Compressor startup failure						

<b>1.Applicable model</b>
All models

<b>2.Error detection method</b>
<ul style="list-style-type: none"> <li>If it fails to change over to the rotor detection operation of compressor motor</li> </ul>

<b>3.Condition of Error displayed</b>
If compressor fails to startup for 42 times

<b>4.Presumable cause</b>
<ul style="list-style-type: none"> <li>Faulty outdoor fan motor</li> <li>Faulty outdoor unit PCB</li> <li>Anomalous power source voltage</li> <li>Improper refrigerant amount and refrigerant circuit</li> <li>Faulty compressor (Motor bearing)</li> </ul>

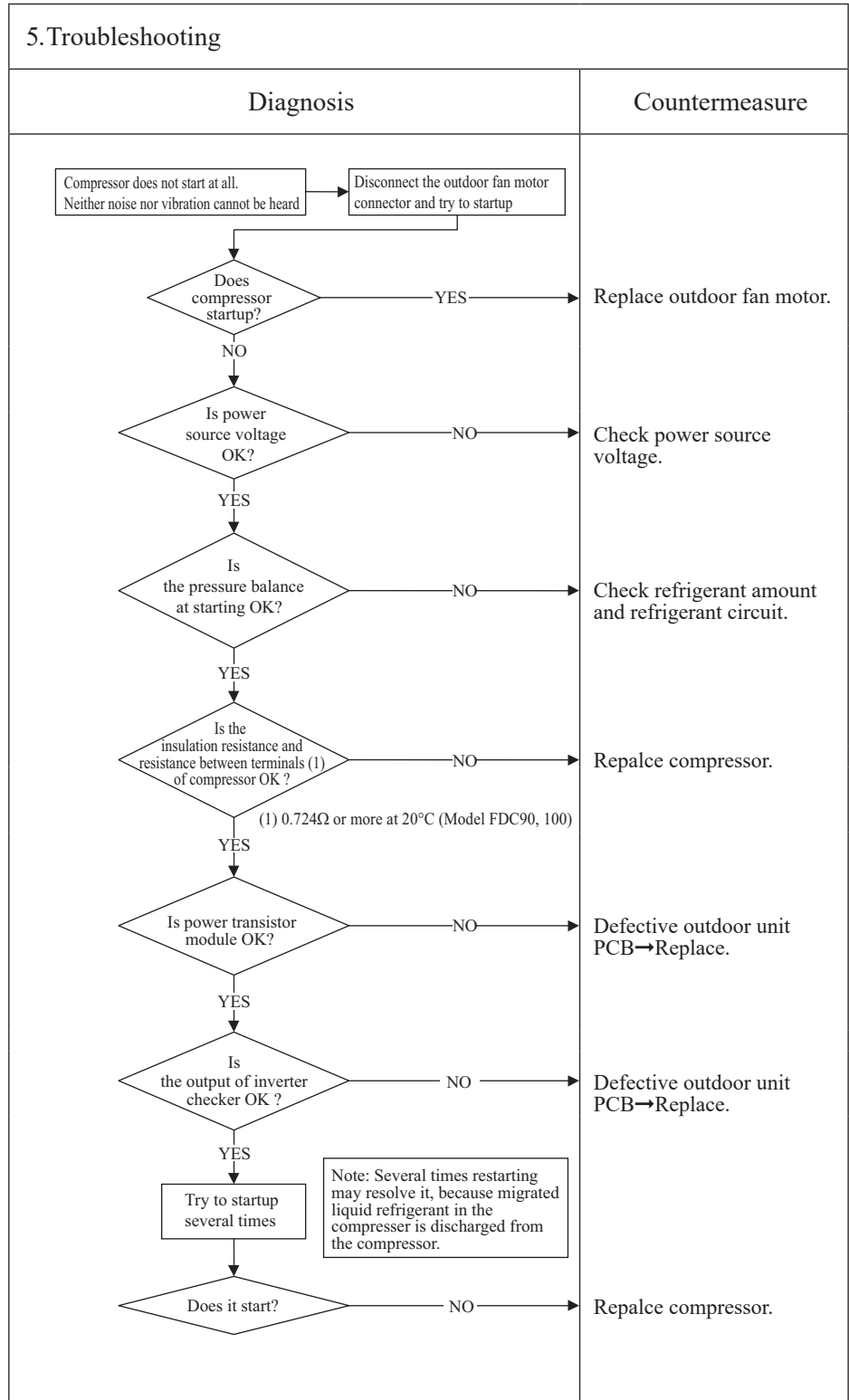

**Note: Insulation resistance**

- The unit is left for long period without power source or soon after installation, migrated liquid refrigerant may dissolve in the refrigerant oil in the compressor. In such case insulation resistance decreases upto several MΩ or lower. If the electric leakage breaker is activated due to low insulation resistance, check followings.
  - Check whehter the insulation resistance can recover or not, ater 6 hours has passed since power ON.  
(By energize the crankcase heater, migrated liquid refrigerant in the refrigerant oil in compressor can be evaporated)
  - Check whether the electric leakage breake conforms to high-hermonic specifications  
(As units has inverter, in order to prevent from improper operation, be sure to use high-hermonic one.)

Error code Remote control: E60	LED	Green	Red	Content <b>Compressor rotor lock error</b>
	Indoor	Keeps flashing	Stays OFF	

<b>1.Applicable model</b>
All models
<b>2.Error detection method</b>
Compressor rotor position
<b>3.Condition of Error displayed</b>
If it fails again to detect the rotor position after shifting to the compressor rotor position detection operation, the compressor stops.
<b>4.Presumable cause</b>
<ul style="list-style-type: none"> <li>• Defective outdoor fan motor</li> <li>• Defective outdoor unit PCB</li> <li>• Anomalous power source voltage</li> <li>• Improper refrigerant amount and refrigerant circuit</li> <li>• Defective compressor (motor, bearing)</li> </ul>

<b>5.Troubleshooting</b>	
<b>Diagnosis</b>	<b>Countermeasure</b>
<pre> graph TD     Q1{Is the power source voltage OK?} -- NO --&gt; C1[Check and correct the power source voltage.]     Q1 -- YES --&gt; R1[Reset the power source and restart operation.]     R1 --&gt; Q2{Does the compressor start?}     Q2 -- NO --&gt; Q3{Does E59 occur?}     Q3 -- YES --&gt; C2[Correct it based on the troubleshooting of E59.]     Q3 -- NO --&gt; Q4{Does the compressor run without occurrence of E42?}     Q4 -- NO --&gt; C3[Correct it based on the troubleshooting of E42.]     Q4 -- YES --&gt; Q5{Is the output from inverter checker OK?}     Q5 -- NO --&gt; C4[Defective outdoor unit PCB -&gt; Replace.]     Q5 -- YES --&gt; Q6{Is the noise or vibration of compressor normal?}     Q6 -- NO --&gt; C5[Replace compressor.]     Q6 -- YES --&gt; Q7{Does it start up normally without recurrence of E60.}     Q7 -- NO --&gt; C6[Check compressor for insulation, resistance. Replace compressor if necessary.]     Q7 -- YES --&gt; C7[Defective outdoor unit PCB -&gt; Replace.]     </pre>	

**Note: Insulation resistance**

- The unit is left for long period without power source or soon after installation, migrated liquid refrigerant may dissolve in the refrigerant oil in the compressor. In such case insulation resistance decreases upto several MΩ or lower. If the electric leakage breaker is activated due to low insulation resistance, check followings.
  - ① Check whether the insulation resistance can recover or not, after 6 hours has passed since power ON.  
(By energize the crankcase heater, migrated liquid refrigerant in the refrigerant oil in compressor can be evaporated.)
  - ② Check whether the electric leakage breaker conforms to high-harmonic specifications.  
(As units has inverter, in order to prevent from improper operation, be sure to use high-harmonic one.)

## 2.2 SRK series

This chapter has described about an indoor unit. Look at 2.1 chapters about the outdoor unit.

### (1) Cautions

- (a) If you are disassembling and checking an air-conditioner, be sure to turn off the power before beginning. When working on indoor units, let the unit sit for about 1 minute after turning off the power before you begin work.
- (b) When taking out printed circuit boards, be sure to do so without exerting force on the circuit boards or package components.
- (c) When disconnecting and connecting connectors, take hold of the connector housing and do not pull on the lead wires.

### (2) Items to check before troubleshooting

- (a) Have you thoroughly investigated the details of the trouble which the customer is complaining about?
- (b) Is the air-conditioner running? Is it displaying any self-diagnosis information?
- (c) Is a power source with the correct voltage connected?
- (d) Are the control lines connecting the indoor and outdoor units wired correctly and connected securely?
- (e) Is the outdoor unit's service valve open?

### (3) Troubleshooting procedure (If the air-conditioner does not run at all)

If the air-conditioner does not run at all, diagnose the trouble using the following troubleshooting procedure. If the air-conditioner is running but breaks down, proceed to troubleshooting step (4).

**Important** When all the following conditions are satisfied, we say that the air-conditioner will not run at all.

- (a) The RUN light does not light up.
- (b) The flaps do not open.
- (c) The indoor unit fan motors do not run.
- (d) The self-diagnosis display does not function.

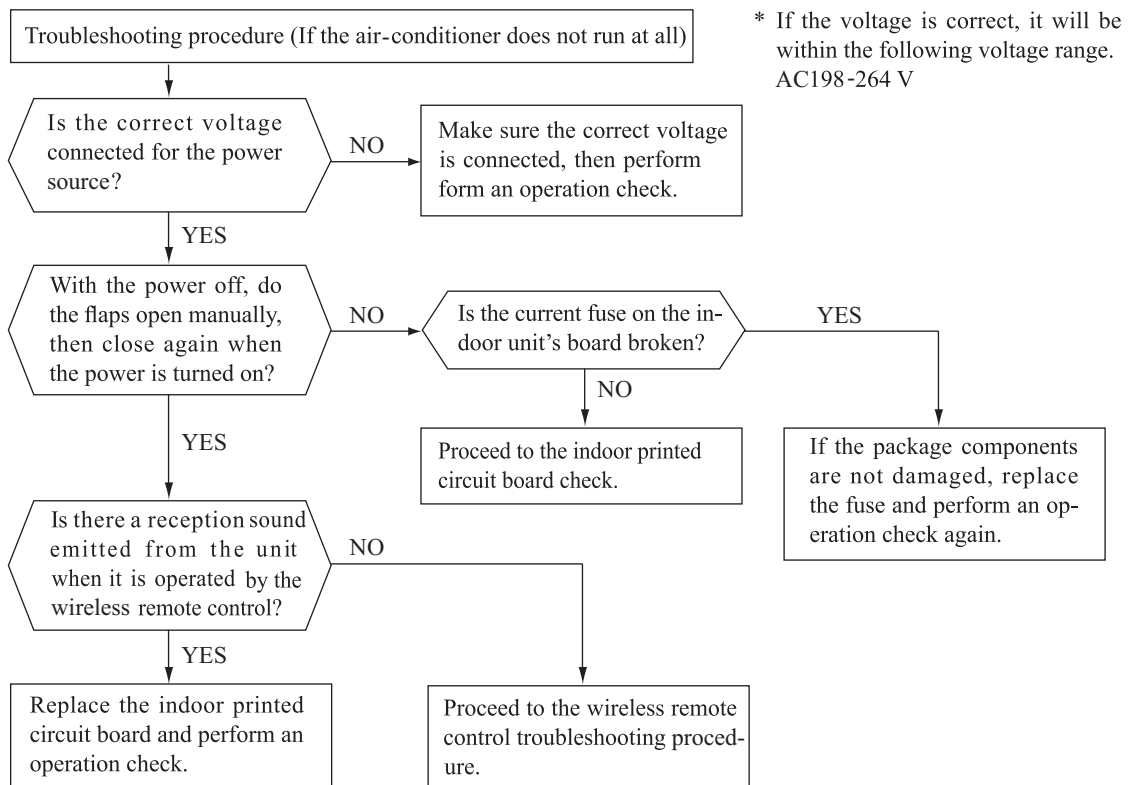

(4) Troubleshooting procedure (If the air-conditioner runs)

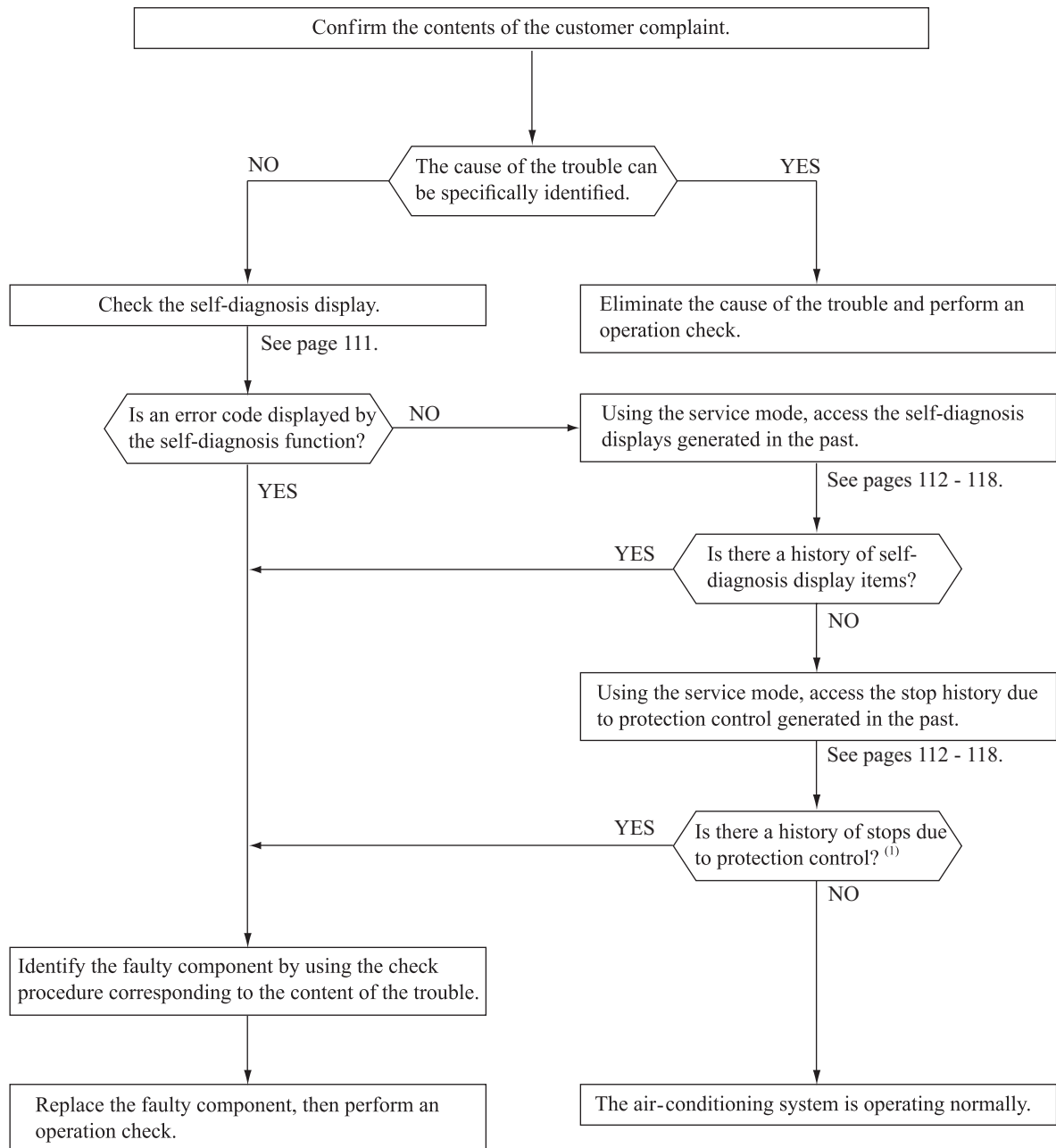

Note (1) Even in cases where only intermittent stop data are generated, the air-conditioning system is normal. However, if the same protective operation recurs repeatedly (3 or more times), it will lead to customer complaints. Judge the conditions in comparison with the contents of the complaints.

## (5) Self-diagnosis table

When this air-conditioner performs an emergency stop, the reason why the emergency stop occurred is displayed by the flashing of display lights. If the air-conditioner is operated using the remote control 3 minutes or more after the emergency stop, the trouble display stops and the air-conditioner resumes operation. <sup>(1)</sup>

Indoor unit display panel		Wired remote control display <sup>(2)</sup>	Description of trouble	Cause	Display (flashing) condition
RUN light	TIMER light				
1-time flash	ON	—	Heat exchanger sensor 1 error	<ul style="list-style-type: none"> <li>Broken heat exchanger sensor 1 wire, poor connector connection</li> <li>Indoor unit PCB is faulty</li> </ul>	When a heat exchanger sensor 1 wire disconnection is detected while operation is stopped. (If a temperature of $-28^{\circ}\text{C}$ or lower is detected for 15 seconds, it is judged that the wire is disconnected.) (Not displayed during operation.)
2-time flash	ON	—	Room temperature sensor error	<ul style="list-style-type: none"> <li>Broken room temperature sensor wire, poor connector connection</li> <li>Indoor unit PCB is faulty</li> </ul>	When a room temperature sensor wire disconnection is detected while operation is stopped. (If a temperature of $-45^{\circ}\text{C}$ or lower is detected for 15 seconds, it is judged that the wire is disconnected.) (Not displayed during operation.)
3-time flash	ON	—	Heat exchanger sensor 2 error	<ul style="list-style-type: none"> <li>Broken heat exchanger sensor 2 wire, poor connector connection</li> <li>Indoor unit PCB is faulty</li> </ul>	When a heat exchanger sensor 2 wire disconnection is detected while operation is stopped. (If a temperature of $-28^{\circ}\text{C}$ or lower is detected for 15 seconds, it is judged that the wire is disconnected.) (Not displayed during operation.)
6-time flash	ON	E 16	Indoor fan motor error	<ul style="list-style-type: none"> <li>Defective fan motor, poor connector connection</li> </ul>	When conditions for turning the indoor unit's fan motor on exist during air-conditioner operation, an indoor unit fan motor speed of $300\text{ min}^{-1}$ or lower is measured for 30 seconds or longer. (The air-conditioner stops.)
Keeps flashing	1-time flash	E 38	Outdoor air temperature sensor error	<ul style="list-style-type: none"> <li>Broken outdoor air temp. sensor wire, poor connector connection</li> <li>Outdoor unit PCB is faulty</li> </ul>	$-55^{\circ}\text{C}$ or lower is detected for 5 seconds continuously 3 times within 40 minutes after initial detection of this anomalous temperature. Or $-55^{\circ}\text{C}$ or lower is detected for within 20 seconds after power ON. (The compressor is stopped.)
Keeps flashing	2-time flash	E 37	Outdoor heat exchanger sensor error	<ul style="list-style-type: none"> <li>Broken heat exchanger sensor wire, poor connector connection</li> <li>Outdoor unit PCB is faulty</li> </ul>	$-55^{\circ}\text{C}$ or lower is detected for 5 seconds continuously 3 times within 40 minutes after initial detection of this anomalous temperature. Or $-55^{\circ}\text{C}$ or lower is detected for within 20 seconds after power ON. (The compressor is stopped.)
Keeps flashing	4-time flash	E 39	Discharge pipe sensor error	<ul style="list-style-type: none"> <li>Broken discharge pipe sensor wire, poor connector connection</li> <li>Outdoor PCB is faulty</li> </ul>	$-25^{\circ}\text{C}$ or lower is detected for 5 seconds continuously 3 times within 40 minutes after initial detection of this anomalous temperature. (The compressor is stopped.)
ON	1-time flash	E 42	Current cut	<ul style="list-style-type: none"> <li>Compressor locking, open phase on compressor output, short-circuit on power transistor, service valve is closed</li> </ul>	The compressor output current exceeds the set value during compressor start. (The air-conditioner stops.)
ON	2-time flash	E 59	Compressor startup failure	<ul style="list-style-type: none"> <li>Defective compressor</li> <li>Outdoor unit PCB is faulty</li> </ul>	If compressor fails to startup for 42 times.
ON	3-time flash	E 58	Current safe stop	<ul style="list-style-type: none"> <li>Overload operation</li> <li>Overcharge</li> <li>Compressor locking</li> </ul>	When the compressor command speed is lower than the set value and the current safe has operated. (the compressor stops)
ON	4-time flash	E 51	Power transistor anomaly	<ul style="list-style-type: none"> <li>Power transistor error (Outdoor unit PCB is faulty)</li> </ul>	If the power transistor primary current exceeds the setting value for 3 seconds, the compressor stops.
ON	5-time flash	E 36	Discharge pipe temperature error	<ul style="list-style-type: none"> <li>Installation, operation status</li> <li>Discharge pipe temperature sensor</li> <li>Outdoor unit PCB is faulty</li> </ul>	When discharge pipe temperature anomaly is detected 2 times within 60 minutes is compressor stop.
ON	6-time flash	E 5	Error of signal transmission	<ul style="list-style-type: none"> <li>Defective power source, Broken signal wire, defective indoor/outdoor PCB</li> </ul>	When there is no signal between the indoor unit PCB and outdoor unit PCB for 10 seconds or longer (when the power is turned on), or when there is no signal for 7 minute 35 seconds or longer (during operation) (the compressor is stopped).
ON	7-time flash	E 48	Outdoor fan motor error	<ul style="list-style-type: none"> <li>Defective fan motor, poor connector connection</li> </ul>	When the outdoor fan motor speed continues for 30 seconds or longer at $75\text{ min}^{-1}$ or lower. (3 times) (The air-conditioner stops.)
ON	Keeps flashing	E 35	Cooling overload operation	<ul style="list-style-type: none"> <li>Installation, operation status</li> <li>Outdoor heat exchanger temperature sensor</li> <li>Outdoor unit PCB is faulty</li> </ul>	When the value of the outdoor heat exchanger sensor exceeds the set value.
2-time flash	2-time flash	E 60	Compressor rotor lock error	<ul style="list-style-type: none"> <li>Defective compressor</li> </ul>	If it fails again to detect the rotor position after shifting to the compressor rotor position detection operation, the compressor stops.
5-time flash	ON	E 47	Active filter voltage error	<ul style="list-style-type: none"> <li>Outdoor unit PCB is faulty</li> </ul>	Error is displayed if the converter voltage exceeds target voltage (3 times within 20 minutes). Remote control may be set after 3-minute delay. Error is displayed if the converter voltage is lower than 210V.
7-time flash	ON	E 57	Insufficient refrigerant amount or detection of service valve closure	<ul style="list-style-type: none"> <li>Operation status</li> <li>Installation status</li> </ul>	When the insufficient refrigerant amount is detected 3 times within 60 minutes.
7-time flash	1-time flash	E 40	Service valve (gas side) closed operation	<ul style="list-style-type: none"> <li>Service valve (gas side) closed</li> <li>Defective outdoor unit PCB</li> </ul>	If the output current of inverter exceeds the specifications, it makes the compressor stopping. (In heating mode).
—	—	E 1	Error of wired remote control wiring	<ul style="list-style-type: none"> <li>Broken wired remote control wire, defective indoor unit PCB</li> </ul>	The wired remote control wire Y is open. The wired remote control wires X and Y are reversely connected. Noise is penetrating the wired remote control lines. The wired remote control or indoor unit PCB is faulty. (The communications circuit is faulty.)

Notes (1)The air-conditioner cannot be restarted using the remote control for 3 minutes after operation stops.

(2)The wired remote control is option parts.



**(6) Service mode (Trouble mode access function)**

This air-conditioner is capable of recording error displays and protective stops (service data) which have occurred in the past. If self-diagnosis displays cannot be confirmed, it is possible to get a grasp of the conditions at the time trouble occurred by checking these service data.

**(a) Explanation of terms**

Term	Explanation
<b>Service mode</b>	The service mode is the mode where service data are displayed by flashing of the display lights when the operations in item (b) below are performed with the indoor control.
<b>Service data</b>	These are the contents of error displays and protective stops which occurred in the past in the air-conditioner system. Error display contents and protective stop data from past anomalous operations of the air-conditioner system are saved in the indoor unit control's non-volatile memory (memory which is not erased when the power goes off). There are two types of data, self-diagnosis data and stop data, described below.
<b>Self-diagnosis data</b>	These are the data which display the reason why a stop occurred when an error display(self-diagnosis display) occurred in an indoor unit. Data are recorded for up to 5 previous occurrences. Data which are older than the 5th previous occurrence are erased. In addition, data on the temperature of each sensor (room temperature, indoor heat exchanger, outdoor heat exchanger, outdoor air temperature, discharge pipe), remote control information (operation switching, fan speed switching) are recorded when trouble occurs, so more detailed information can be checked.
<b>Stop data</b>	These are the data which display the reason by a stop occurred when the air-conditioning system performed protective stops, etc. in the past. Even if stop data alone are generated, the system restarts automatically. (After executing the stop mode while the display is normal, the system restarts automatically.) Data for up to 10 previous occasions are stored. Data older than the 10th previous occasion are erased. (Important) In cases where transient stop data only are generated, the air-conditioner system may still be normal. However, if the same protective stop occurs frequently (3 or more times), it could lead to customer complaints.

**(b) Service mode display procedure**

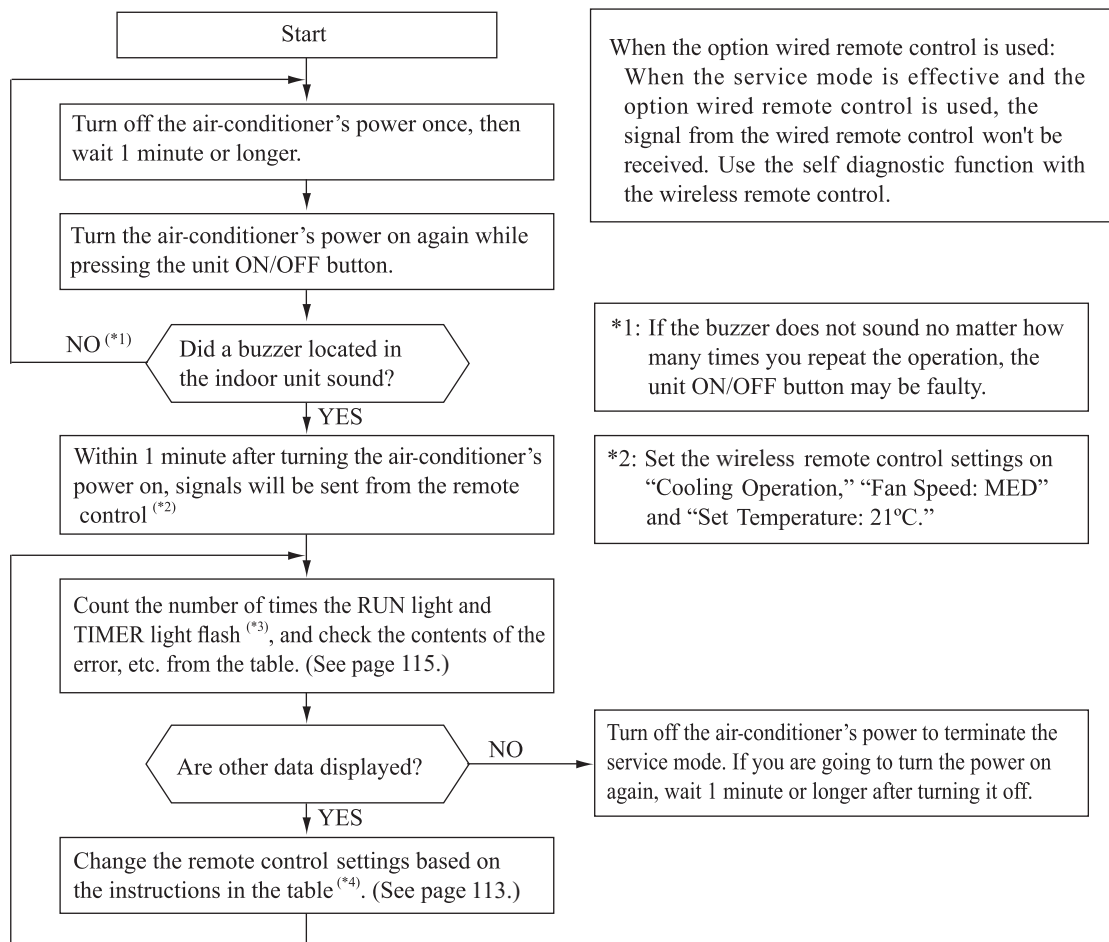

\*3: To count the number of flashes in the service mode, count the number of flashes after the light lights up for 1.5 second initially (start signal). (The time that the light lights up for 1.5 second (start signal) is not counted in the number of flashes.)

• In the case of current cut (example: stop code "42")  
 The RUN light (10's digit) 4-time flash and the TIMER light (1's digit) 2-time flash.  
 $4 \times 10 + 2 \times 1 = 42 \rightarrow$  From the table, read the instructions for error code 42, "current cut".

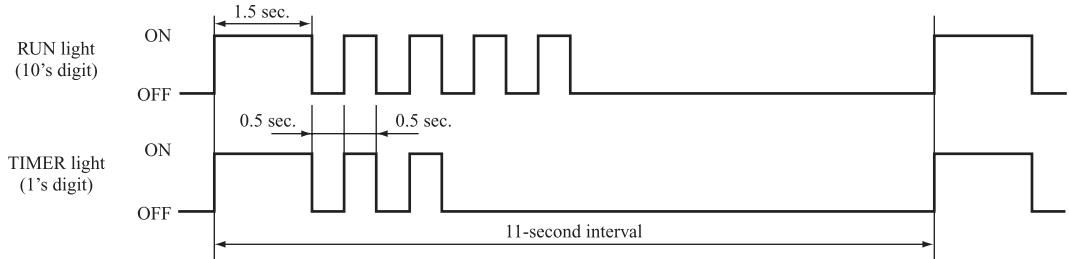

\*4: When in the service mode, when the wireless remote control settings (operation mode, fan speed mode, temperature setting) are set as shown in the following table and sent to the air-conditioner unit, the unit switches to display of service data.

**(i) Self-diagnosis data**

What are Self-diagnosis Data?

These are control data (reasons for stops, temperature at each sensor, wireless remote control information) from the time when there were error displays (a bnormal stops) in the indoor unit in the past.

Data from up to 5 previous occasions are stored in memory. Data older than the 5th previous occasion are erased.

The temperature setting indicates how many occasions previous to the present setting the error display data are and the operation mode and fan speed mode data show the type of data.

Wireless remote control setting		Contents of output data
Operation mode	Fan speed mode	
Cooling	MED	Displays the reason for stopping display in the past (error code).
	HI	Displays the room temperature sensor temperature at the time the error code was displayed in the past.
	AUTO	Displays the indoor heat exchanger sensor temperature at the time the error code was displayed in the past.
Heating	LO	Displays the wireless remote control information at the time the error code was displayed in the past.
	MED	Displays the outdoor air temperature sensor temperature at the time the error code was displayed in the past.
	HI	Displays the outdoor heat exchanger sensor temperature at the time the error code was displayed in the past.
	AUTO	Displays the discharge pipe sensor temperature at the time the error code was displayed in the past.

Wireless remote control setting	Indicates the number of occasions previous to the present the error display data are from.
Temperature setting	
21°C	1 time previous (previous time)
22°C	2 times previous
23°C	3 times previous
24°C	4 times previous
25°C	5 times previous

**Only for indoor heat exchanger temperature sensor 2**

Wireless remote control setting	Indicates the number of occasions previous to the present the error display data are from.
Temperature setting	
26°C	1 time previous (previous time)
27°C	2 times previous
28°C	3 times previous
29°C	4 times previous
30°C	5 times previous

(Example)

Wireless remote control setting			Displayed data
Operation mode	Fan speed mode	Temperature setting	
Cooling	MED	21°C	Displays the reason for the stop (error code) the previous time an error was displayed.
		22°C	Displays the reason for the stop (error code) 2 times previous when an error was displayed.
		23°C	Displays the reason for the stop (error code) 3 times previous when an error was displayed.
		24°C	Displays the reason for the stop (error code) 4 times previous when an error was displayed.
		25°C	Displays the reason for the stop (error code) 5 times previous when an error was displayed.

(ii) Stop data

Wireless remote control setting			Displayed data
Operation mode	Fan speed mode	Temperature setting	
Cooling	LO	21°C	Displays the reason for the stop (stop code) the previous time when the air-conditioner was stopped by protective stop control.
		22°C	Displays the reason for the stop (stop code) 2 times previous when the air-conditioner was stopped by protective stop control.
		23°C	Displays the reason for the stop (stop code) 3 times previous when the air-conditioner was stopped by protective stop control.
		24°C	Displays the reason for the stop (stop code) 4 times previous when the air-conditioner was stopped by protective stop control.
		25°C	Displays the reason for the stop (stop code) 5 times previous when the air-conditioner was stopped by protective stop control.
		26°C	Displays the reason for the stop (stop code) 6 times previous when the air-conditioner was stopped by protective stop control.
		27°C	Displays the reason for the stop (stop code) 7 times previous when the air-conditioner was stopped by protective stop control.
		28°C	Displays the reason for the stop (stop code) 8 times previous when the air-conditioner was stopped by protective stop control.
		29°C	Displays the reason for the stop (stop code) 9 times previous when the air-conditioner was stopped by protective stop control.
		30°C	Displays the reason for the stop (stop code) 10 times previous when the air-conditioner was stopped by protective stop control.

(c) Error code, stop code table (Assignment of error codes and stop codes is done in common for all models.)

Number of flashes when in service mode		Stop code or Error code	Error content	Cause	Occurrence conditions	Error display	Auto recovery
RUN light (10's digit)	TIMER light (1's digit)						
OFF	OFF	0	Normal	—	—	—	—
	1-time flash	01	Error of wired remote control wiring	Broken wired remote control wire, defective indoor unit PCB	The wired remote control wire Y is open. The wired remote control wires X and Y are reversely connected. Noise is penetrating the wired remote control lines. The wired remote control or indoor unit PCB is faulty.	—	○
	5-time flash	05	Can not receive signals for 35 seconds (if communications have recovered)	Power source is faulty. Power source cables and signal lines are improperly wired. Indoor or outdoor unit PCB are faulty.	When 35 seconds passes without communications signals from either the outdoor unit or the indoor unit being detected correctly.	○	—
3-time flash	5-time flash	35	Cooling high pressure control	Cooling overload operation. Outdoor unit fan speed drops. Outdoor heat exchanger sensor is short-circuit.	When the outdoor heat exchanger sensor's value exceeds the set value.	○ (5 times)	○
	6-time flash	36	Compressor overheat 115°C	Refrigerant is insufficient. Discharge pipe sensor is faulty. Service valve is closed.	When the discharge pipe sensor's value exceeds the set value.	○ (2 times)	○
	7-time flash	37	Outdoor heat exchanger sensor is abnormal	Outdoor heat exchanger sensor wire is disconnected. Connector connections are poor. Outdoor unit PCB is faulty.	-55°C or lower is detected for 5 seconds continuously 3 times within 40 minutes after initial detection of this anomalous temperature. Or -55°C lower is detected for 5 seconds continuously within 20 seconds after power ON.	○ (3 times)	○
	8-time flash	38	Outdoor air temperature sensor is abnormal	Outdoor air temperature sensor wire is disconnected. Connector connections are poor. Outdoor unit PCB is faulty.	-55°C or lower is detected for 5 seconds continuously 3 times within 40 minutes after initial detection of this anomalous temperature. Or -55°C lower is detected for 5 seconds continuously within 20 seconds after power ON.	○ (3 times)	○
	9-time flash	39	Discharge pipe sensor is abnormal (anomalous stop)	Discharge pipe sensor wire is disconnected. Connector connections are poor. Outdoor unit PCB is faulty.	-25°C or lower is detected for 5 seconds continuously 3 times within 40 minutes after initial detection of this anomalous temperature.	○ (3 times)	○
4-time flash	OFF	40	Service valve (gas side) closed operation	Service valve (gas side) closed. Outdoor unit PCB is faulty.	If the inverter output current value exceeds the setting value within 80 seconds after the compressor ON in the heating mode, the compressor stops.	○ (2 times)	○
	2-time flash	42	Current cut	Compressor lock. Compressor wiring short-circuit. Compressor output is open phase. Outdoor unit PCB is faulty. Service valve is closed. Electronic expansion valve is faulty. Compressor is faulty.	In order to prevent from overcurrent of inverter, if the current exceeds the specifications, it makes the compressor stopping.	○ (2 times)	○
	7-time flash	47	Active filter voltage error	Defective active filter.	Error is displayed if the converter voltage exceeds target voltage (3 times within 20 minutes). Remote control may be set after 3-minute delay. Error is displayed if the converter voltage is lower than 210V (1-time within 5 seconds after power ON).	○	—
	8-time flash	48	Outdoor unit's fan motor is abnormal	Outdoor fan motor is faulty. Connector connections are poor. Outdoor unit PCB is faulty.	When a fan speed of 75 min <sup>-1</sup> or lower continues for 30 seconds or longer.	○ (3 times)	○
5-time flash	1-time flash	51	Short-circuit in the power transistor (high side) Current cut circuit breakdown	Outdoor unit PCB is faulty. Power transistor is damaged.	When it is judged that the power transistor was damaged at the time the compressor started.	○	—
	7-time flash	57	Refrigeration cycle system protective control	Service valve is closed. Refrigerant is insufficient.	When refrigeration cycle system protective control operates.	○ (3 times)	○
	8-time flash	58	Current safe	Refrigerant is overcharge. Compressor lock. Overload operation.	When there is a current safe stop during operation.	—	○
	9-time flash	59	Compressor wiring is unconnection voltage drop Low speed protective control	Compressor wiring is disconnected. Power transistor is damaged. Power source construction is defective. Outdoor unit PCB is faulty. Compressor is faulty.	When the current is 1A or less at the time the compressor started. When the power source voltage drops during operation. When the compressor command speed is lower than 32 rps for 60 minutes.	○	○
6-time flash	OFF	60	Rotor lock	Compressor is faulty. Compressor output is open phase. Electronic expansion valve is faulty. Overload operation. Outdoor unit PCB is faulty.	After the compressor starts, when the compressor stops due to rotor lock.	○ (2 times)	○
	1-time flash	61	Connection lines between the indoor and outdoor units are faulty	Connection lines are faulty. Indoor or outdoor unit PCB are faulty.	When 10 seconds passes after the power is turned on without communications signals from the indoor or outdoor unit being detected correctly.	○	—
	2-time flash	62	Serial transmission error	Indoor or outdoor unit PCB are faulty. Noise is causing faulty operation.	When 7 minutes 35 seconds passes without communications signals from either the outdoor unit or the indoor unit being detected correctly.	○	—
8-time flash	OFF	80	Indoor unit's fan motor is abnormal	Indoor fan motor is faulty. Connector connections are poor. Indoor unit PCB is faulty.	When the indoor fan motor is detected to be running at 300 min <sup>-1</sup> or lower speed with the fan motor in the ON condition while the air-conditioner is running.	○	—
	2-time flash	82	Indoor heat exchanger sensor is abnormal (anomalous stop)	Indoor heat exchanger sensor wire is disconnected. Connector connections are poor.	When a temperature of -28°C or lower is sensed continuously for 40 minutes during heating operation. (the compressor stops).	○	—
	4-time flash	84	Anti-condensation control	High humidity condition. Humidity sensor is faulty.	Anti-condensation prevention control is operating.	—	○
	5-time flash	85	Anti-frost control	Indoor unit fan speed drops. Indoor heat exchanger sensor is broken wire.	When the anti-frost control operates and the compressor stops during cooling operation.	—	○
	6-time flash	86	Heating high pressure control	Heating overload operation. Indoor unit fan speed drops. Indoor heat exchanger sensor is short-circuit.	When high pressure control operates during heating operation and the compressor stops.	—	○

Notes (1) The number of flashes when in the service mode do not include the 1.5 second period when the lights light up at first (start signal). (See the example shown below.)

• In the case of current cut (example: stop code "42")  
 The RUN light (10's digit) 4-time flash and the TIMER light (1's digit) 2-time flash.  
 $4 \times 10 + 2 \times 1 = 42 \rightarrow$  From the table, read the instructions for error code 42, "current cut".

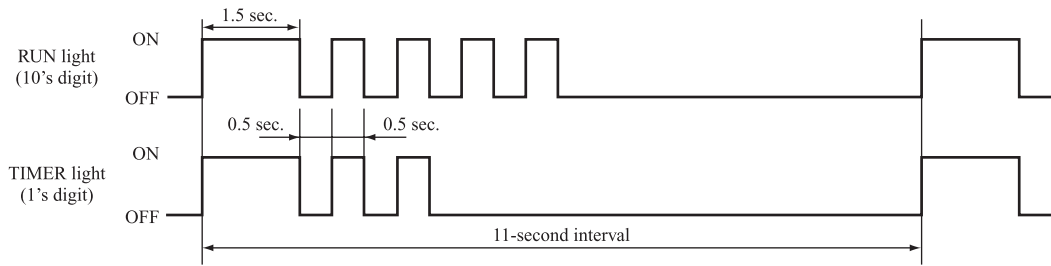

- (2) Error display:   
 — Is not displayed. (automatic recovery only)  
 Displayed.  
 If there is a ( ) displayed, the error display shows the number of times that an auto recovery occurred for the same reason has reached the number of times in ( ).  
 If no ( ) is displayed, the error display shows that the trouble has occurred once.
- (3) Auto Recovery:   
 — Does not occur  
 Auto recovery occurs.

**(d) Operation mode, Fan speed mode information tables**

**(i) Operation mode**

Display pattern when in service mode	Operation mode when there is an abnormal stop
<b>RUN light (10's digit)</b>	
—	AUTO
1-time flash	DRY
2-time flash	COOL
3-time flash	FAN
4-time flash	HEAT

**(ii) Fan speed mode**

Display pattern when in service mode	Fan speed mode when there is an abnormal stop
<b>TIMER light (1's digit)</b>	
—	AUTO
2-time flash	HI
3-time flash	MED
4-time flash	LO
5-time flash	ULO
6-time flash	HI POWER
7-time flash	ECONO

\* If no data are recorded (error code is normal), the information display in the operation mode and fan speed mode becomes as follows.

Mode	Display when error code is normal
<b>Operation mode</b>	AUTO
<b>Fan speed mode</b>	AUTO

(Example): Operation mode: COOL, Fan speed mode: HI

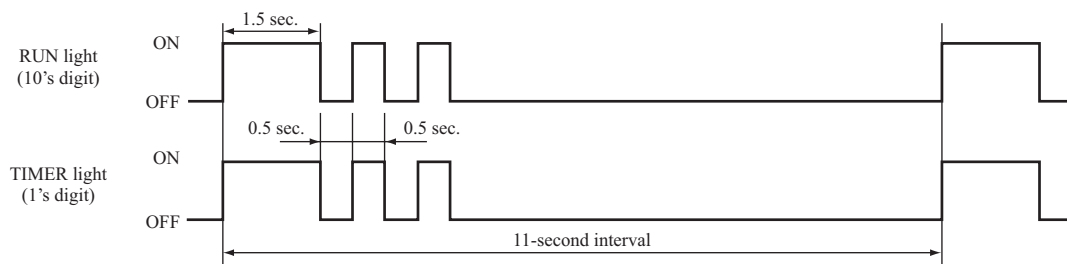

(e) Temperature information

(i) Room temperature sensor, indoor heat exchanger temperature sensor, outdoor air temperature sensor, outdoor heat exchanger temperature sensor temperature

Unit: °C

Buzzer sound	RUN light (10's digit)	TIMER light (1's digit)									
		0	1	2	3	4	5	6	7	8	9
Yes (sounds for 0.1 second)	6	-60	-61	-62	-63	-64					
	5	-50	-51	-52	-53	-54	-55	-56	-57	-58	-59
	4	-40	-41	-42	-43	-44	-45	-46	-47	-48	-49
	3	-30	-31	-32	-33	-34	-35	-36	-37	-38	-39
	2	-20	-21	-22	-23	-24	-25	-26	-27	-28	-29
	1	-10	-11	-12	-13	-14	-15	-16	-17	-18	-19
	0		-1	-2	-3	-4	-5	-6	-7	-8	-9
No (does not sound)	0	0	1	2	3	4	5	6	7	8	9
	1	10	11	12	13	14	15	16	17	18	19
	2	20	21	22	23	24	25	26	27	28	29
	3	30	31	32	33	34	35	36	37	38	39
	4	40	41	42	43	44	45	46	47	48	49
	5	50	51	52	53	54	55	56	57	58	59
	6	60	61	62	63	64	65	66	67	68	69
	7	70	71	72	73	74	75	76	77	78	79
	8	80	81	82	83	84	85	86	87	88	89
	9	90	91	92	93	94	95	96	97	98	99

\* If no data are recorded (error code is normal), the display for each temperature information becomes as shown below.

Sensor name	Sensor value displayed when the error code is normal
Room temperature sensor	-64°C
Indoor heat exchanger temperature sensor	-64°C
Outdoor air temperature sensor	-64°C
Outdoor heat exchanger temperature sensor	-64°C

(Example) Outdoor heat exchanger temperature data: “-9°C”

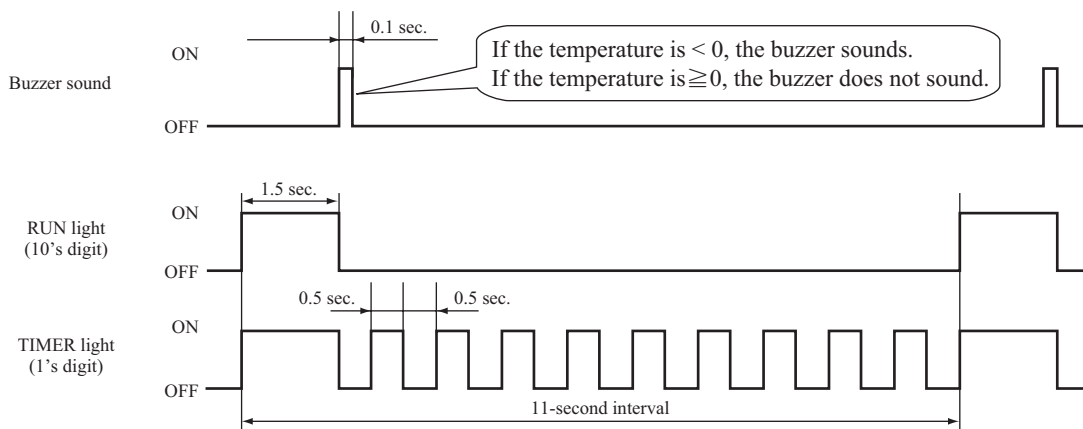

(ii) Discharge pipe sensor temperature

Unit: °C

Buzzer sound	RUN light (10's digit)	TIMER light (1's digit)											
		0	1	2	3	4	5	6	7	8	9		
Yes (sounds for 0.1 second)	3	-60	-62	-64									
	2	-40	-42	-44	-46	-48	-50	-52	-54	-56	-58		
	1	-20	-22	-24	-26	-28	-30	-32	-34	-36	-38		
	0	/	-2	-4	-6	-8	-10	-12	-14	-16	-18		
No (does not sound)	0	0	2	4	6	8	10	12	14	16	18		
	1	20	22	24	26	28	30	32	34	36	38		
	2	40	42	44	46	48	50	52	54	56	58		
	3	60	62	64	66	68	70	72	74	76	78		
	4	80	82	84	86	88	90	92	94	96	98		
	5	100	102	104	106	108	110	112	114	116	118		
	6	120	122	124	126	128	130	132	134	136	138		
	7	140	142	144	146	148	150						

\* If no data are recorded (error code is normal), the display for each temperature information becomes as shown below.

Sensor name	Sensor value displayed when the error code is normal
Discharge pipe sensor	-64°C

(Example) Discharge pipe temperature data: "122°C"

\* In the case of discharge pipe data, multiply the reading value by 2. (Below, 61 x 2 = "122°C")

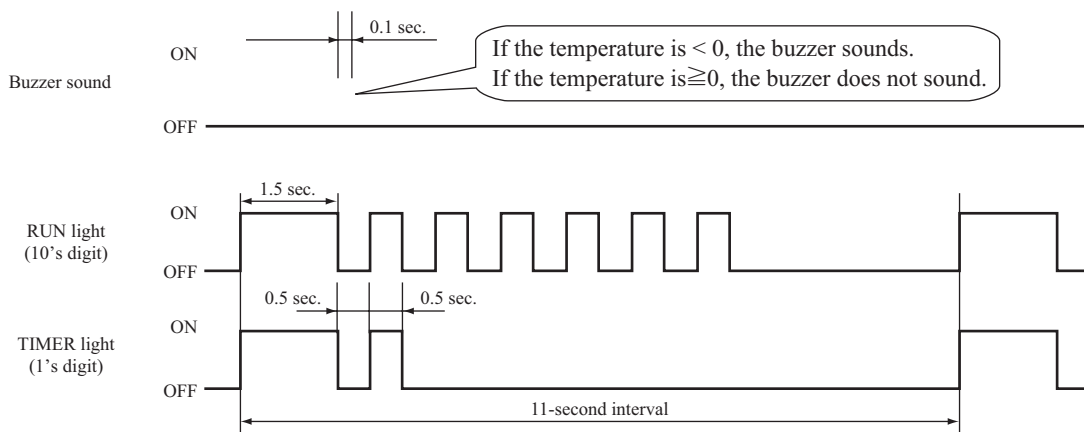

## Service data record form

Customer		Model					
Date of investigation							
Machine name							
Content of complaint							
Wireless remote control settings			Content of displayed data	Display results			Display content
Temperature setting	Operation mode	Fan speed mode		Buzzer (Yes/No.)	RUN light (Times)	TIMER light (Times)	
21	Cooling	MED	Error code on previous occasion.	/			
		HI	Room temperature sensor on previous occasion.				
		AUTO	Indoor heat exchanger sensor 1 on previous occasion.				
	Heating	LO	Wireless remote control information on previous occasion.	/			
		MED	Outdoor air temperature sensor on previous occasion.				
		HI	Outdoor heat exchanger sensor on previous occasion.				
	AUTO	Discharge pipe sensor on previous occasion.					
26	Cooling	AUTO	Indoor heat exchanger sensor 2 on previous occasion.				
22	Cooling	MED	Error code on second previous occasion.	/			
		HI	Room temperature sensor on second previous occasion.				
		AUTO	Indoor heat exchanger sensor 1 on second previous occasion.				
	Heating	LO	Wireless remote control information on second previous occasion.	/			
		MED	Outdoor air temperature sensor on second previous occasion.				
		HI	Outdoor heat exchanger sensor on second previous occasion.				
	AUTO	Discharge pipe sensor on second previous occasion.					
27	Cooling	AUTO	Indoor heat exchanger sensor 2 on second occasion.				
23	Cooling	MED	Error code on third previous occasion.	/			
		HI	Room temperature sensor on third previous occasion.				
		AUTO	Indoor heat exchanger sensor 1 on third previous occasion.				
	Heating	LO	Wireless remote control information on third previous occasion.	/			
		MED	Outdoor air temperature sensor on third previous occasion.				
		HI	Outdoor heat exchanger sensor on third previous occasion.				
	AUTO	Discharge pipe sensor on third previous occasion.					
28	Cooling	AUTO	Indoor heat exchanger sensor 2 on third occasion.				
24	Cooling	MED	Error code on fourth previous occasion.	/			
		HI	Room temperature sensor on fourth previous occasion.				
		AUTO	Indoor heat exchanger sensor 1 on fourth previous occasion.				
	Heating	LO	Wireless remote control information on fourth previous occasion.	/			
		MED	Outdoor air temperature sensor on fourth previous occasion.				
		HI	Outdoor heat exchanger sensor on fourth previous occasion.				
	AUTO	Discharge pipe sensor on fourth previous occasion.					
29	Cooling	AUTO	Indoor heat exchanger sensor 2 on fourth occasion.				
25	Cooling	MED	Error code on fifth previous occasion.	/			
		HI	Room temperature sensor on fifth previous occasion.				
		AUTO	Indoor heat exchanger sensor 1 on fifth previous occasion.				
	Heating	LO	Wireless remote control information on fifth previous occasion.	/			
		MED	Outdoor air temperature sensor on fifth previous occasion.				
		HI	Outdoor heat exchanger sensor on fifth previous occasion.				
	AUTO	Discharge pipe sensor on fifth previous occasion.					
30	Cooling	AUTO	Indoor heat exchanger sensor 2 on fifth occasion.				
21	Cooling	LO	Stop code on previous occasion.				
22			Stop code on second previous occasion.				
23			Stop code on third previous occasion.				
24			Stop code on fourth previous occasion.				
25			Stop code on fifth previous occasion.				
26			Stop code on sixth previous occasion.				
27			Stop code on seventh previous occasion.				
28			Stop code on eighth previous occasion.				
29			Stop code on ninth previous occasion.				
30			Stop code on tenth previous occasion.				
Judgment							Examiner
Remarks							

Note (1) In the case of indoor heat exchanger sensor 2, match from 26 to 30 the temperature setting of wireless remote control. (Refer to page 114)



(7) Inspection procedures corresponding to detail of trouble

**Sensor error**

[ Broken sensor wire, connector poor connection ]

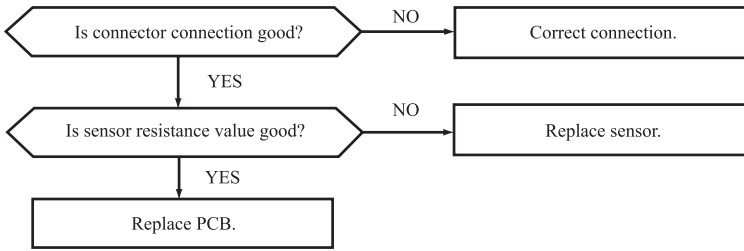

◆ **Sensor temperature characteristics**  
(Room temperature, indoor heat exchanger temperature)

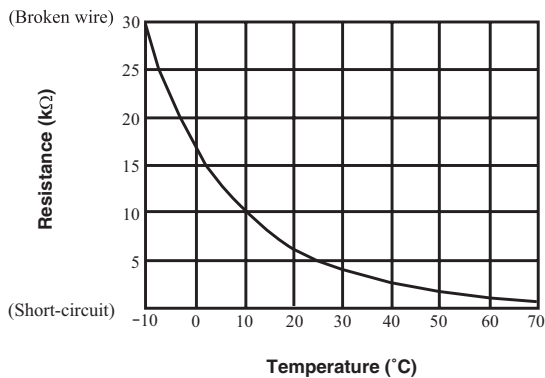

**Indoor fan motor error**

[ Defective fan motor, connector poor connection, defective indoor unit PCB ]

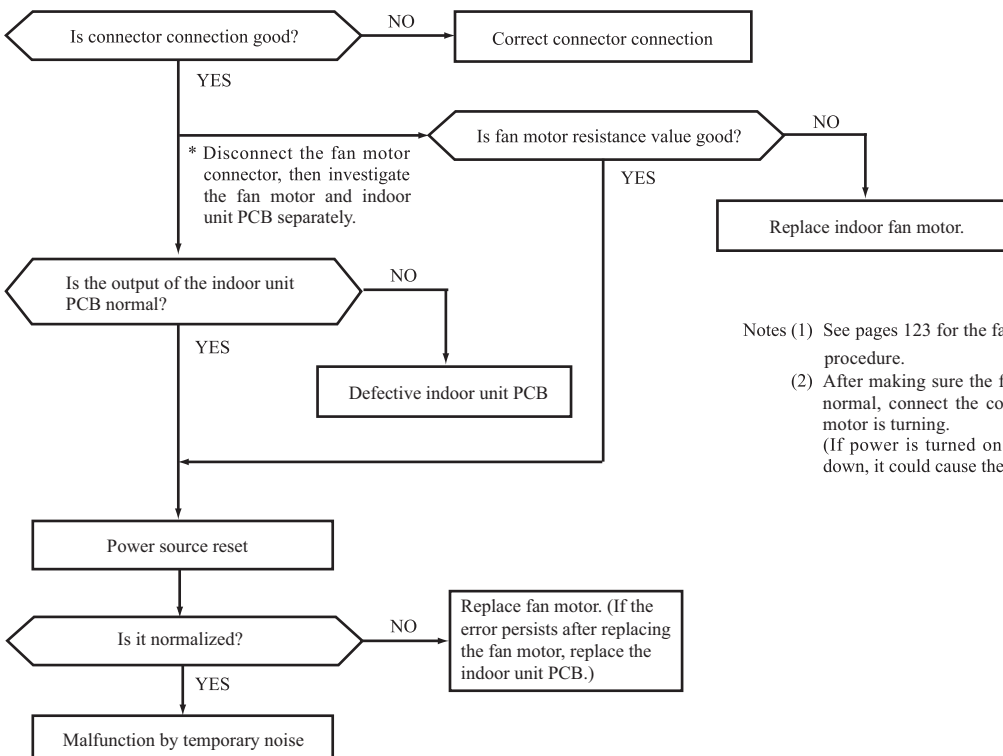

Notes (1) See pages 123 for the fan motor and indoor unit PCB check procedure.  
(2) After making sure the fan motor and indoor unit PCB are normal, connect the connectors and confirm that the fan motor is turning.  
(If power is turned on while one or the other is broken down, it could cause the other to break down also.)

**Error of signal transmission**

[ Wiring error including power cable, defective indoor/  
outdoor unit PCB ]

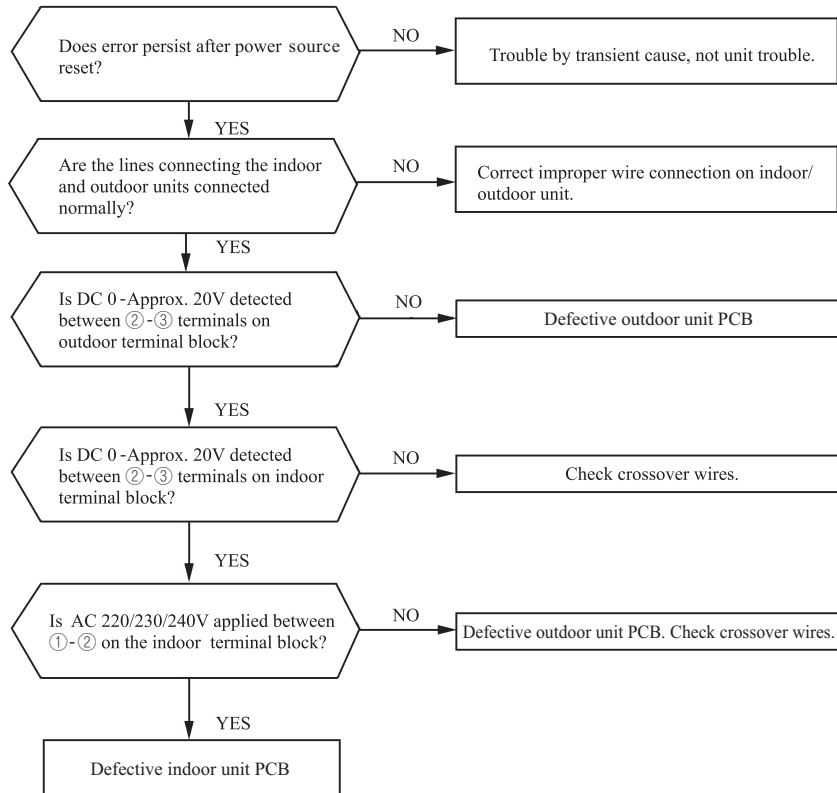

**(8) Phenomenon observed after short-circuit, wire breakage on sensor**

Sensor	Operation mode	Phenomenon	
		Shortcircuit	Disconnected wire
Room temperature sensor	Cooling	Release of continuous compressor operation command.	Continuous compressor operation command is not released.
	Heating	Continuous compressor operation command is not released.	Release of continuous compressor operation command.
Heat exchanger temperature sensor	Cooling	Freezing cycle system protection trips and stops the compressor.	Continuous compressor operation command is not released. (Anti-frosting)
	Heating	High pressure control mode (Compressor stop command)	Hot keep (Indoor fan stop)
Humidity sensor	Cooling	Refer to the table below.	Refer to the table below.
	Heating	Normal system operation is possible.	

**■ Humidity sensor operation**

Failure mode	Control input circuit resding	Air-conditioning system operation
Disconnected wire	① Disconnected wire	Humidity reading is 0%
	② Disconnected wire	
	①② Disconnected wire	
Short-circuit	① and ② are short-circuited	Humidity reading is 100%

Remark: Do not perform a continuity check of the humidity sensor with a tester. If DC current is applied, it could damage the sensor.

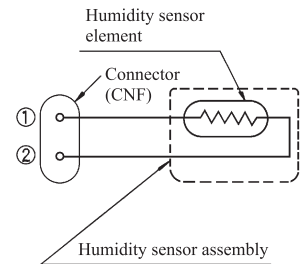

**(9) Checking the indoor electrical equipment**

**(a) Indoor unit PCB check procedure**

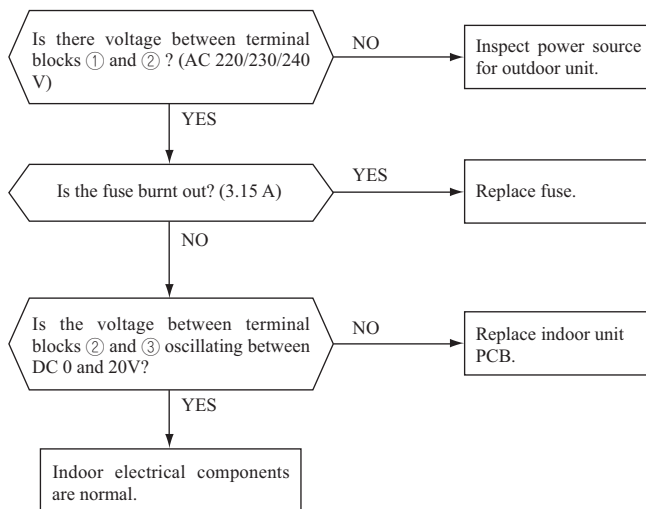

**(b) Indoor fan motor check procedure**

This is a diagnostic procedure for determining if the indoor fan motor or the indoor unit PCB is broken down.

**(i) Indoor unit PCB output check**

- 1) Turn off the power.
- 2) Remove the front panel, then disconnect the fan motor lead wire connector.
- 3) Turn on the power. If the unit operates when the ON/OFF button is pressed, if trouble is detected after the voltages in the following figure are output for approximately 30 seconds, it means that the indoor unit PCB is normal and the fan motor is broken down

If the voltages in the following figure are not output at connector pins No. ①, ④ and ⑤, the indoor unit PCB has failed and the fan motor is normal.

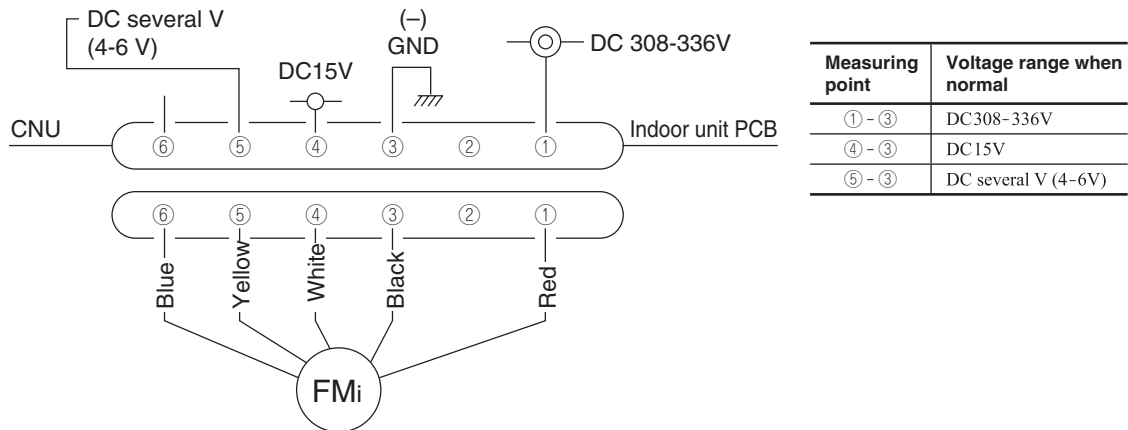

**(ii) Fan motor resistance check**

Measuring point	Resistance when normal
① - ③ (Red - Black)	20 MΩ or higher
④ - ③ (White - Black)	20 kΩ or higher

- Notes (1) Remove the fan motor and measure it without power connected to it.  
 (2) If the measured value is below the value when the motor is normal, it means that the fan motor is faulty.

**(10) How to make sure of wireless remote control**

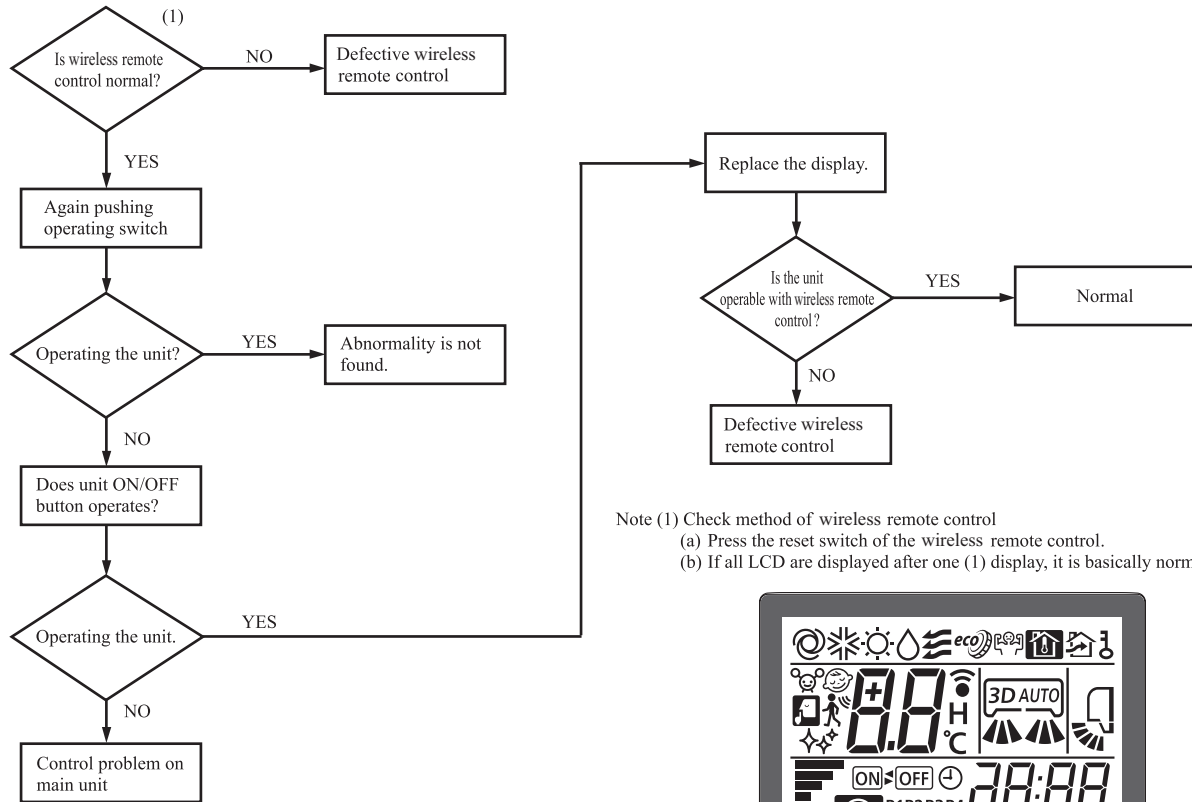

Note (1) Check method of wireless remote control  
 (a) Press the reset switch of the wireless remote control.  
 (b) If all LCD are displayed after one (1) display, it is basically normal.

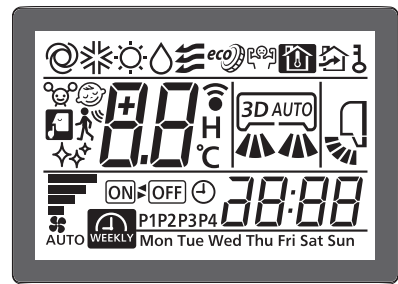

◆ Simplified check method of wireless remote control  
 It is normal if the signal transmission section of the wireless remote control emits a whitish light at each transmission on the monitor of digital camera.

**(11) Inspection procedure for blown fuse on the indoor unit PCB**

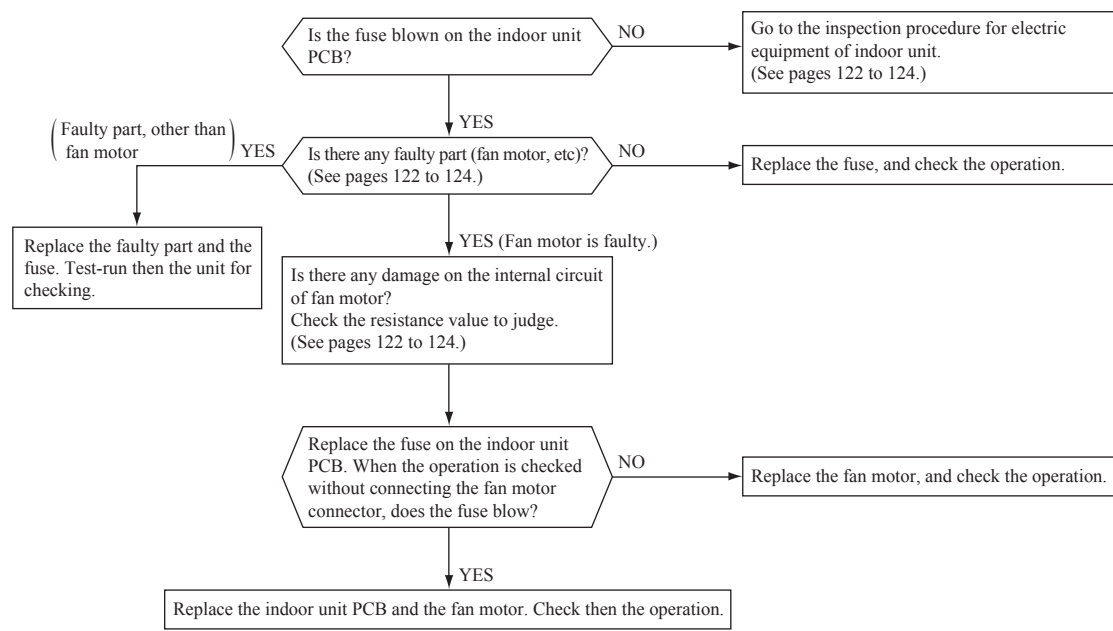

# 3. ELECTRICAL WIRING

## (1) Indoor units

### (a) Ceiling cassette-4 way type (FDT)

#### Model FDT100VH

Meaning of marks

Item	Description
AM1-4	Draft prevention function motor
CNB-Z	Connector
DM	Drain pump motor
F1,2	Fuse
FMI	Fan motor
FS	Float switch
HS	Humidity sensor
L	Reactor
LED- 2	Indication lamp ( Green-Nominal operation )
LED- 3	Indication lamp ( Red-Inspection )
LM1-4	Lower motor
PIS	Motion sensor
SW2	Remote control communication address
SW5	Plural units Master / Slave setting
SW6	Model capacity setting
SW7-1	Operation check, drain pump motor test run
TB1	Terminal block ( Power source ) ( □ mark )
TB2	Terminal block ( Signal line ) ( □ mark )
ThC	Temperature sensor ( Remote control )
Thi-A	Temperature sensor ( Return air )
Thi-R1,2,3	Temperature sensor ( Heat exchanger )

Color marks

Mark	Color	Mark	Color
BK	Black	WH	White
BL	Blue	YE	Yellow
BR	Brown	GY	Grey
OR	Orange	YE / GN	Yellow / Green
RD	Red		

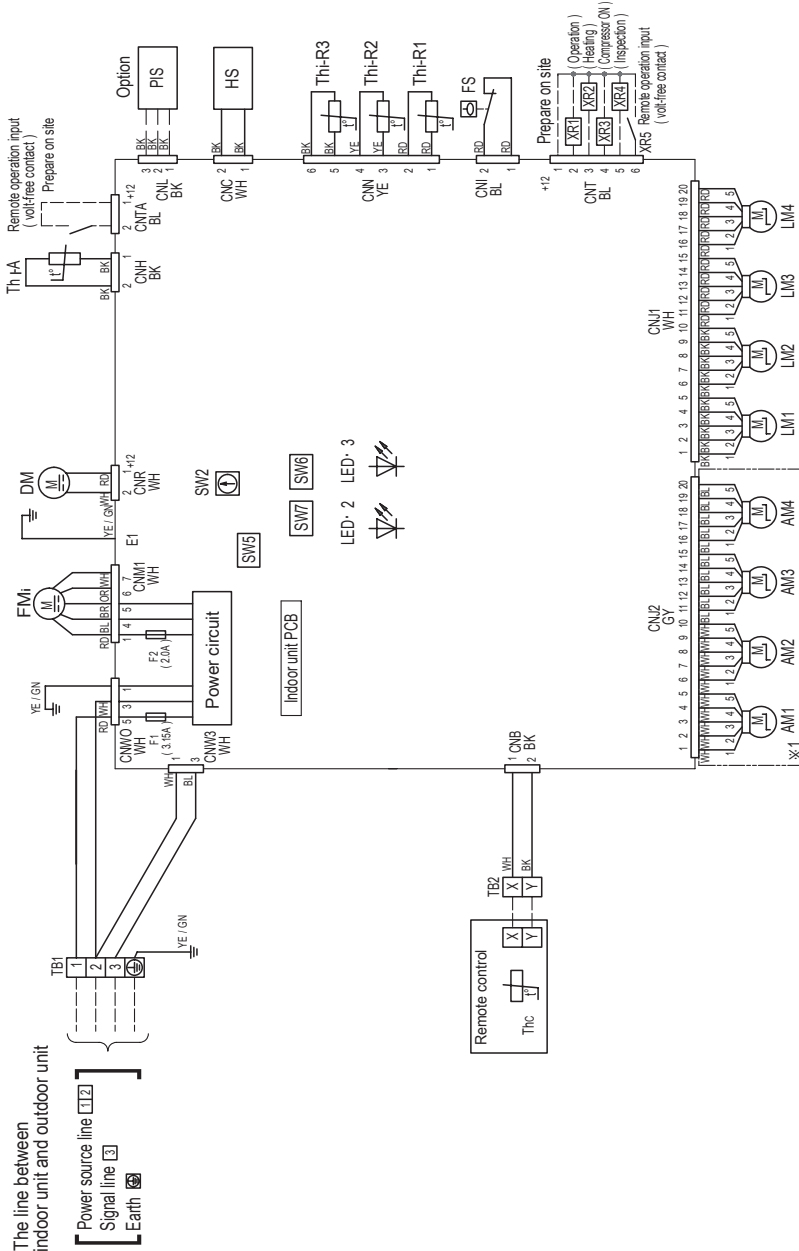

- Notes
1. — indicates wiring on site.
  2. See the wiring diagram of outside unit about the line between indoor unit and outdoor unit.
  3. Use twin core cord ( 0.3mm<sup>2</sup> ) at remote control line.  
See spec sheet of remote control in case that the total length is more than 100m.
  4. Do not put remote control line alongside power source line.
  5. Section 1 ( ※ 1 ) is provided on the panel T-PSAE-SAM-E only.

PJF000Z554

(b) Duct connected-High static pressure type (FDU)  
 Model FDU100VH

Meaning of marks

Item	Description
CNB-Z	Connector
DM	Drain pump motor
F1,3,4	Fuse
FM1,2	Fan motor
FS	Ficut switch
L	Reactor
LED-2	Indication lamp (Green-Normal operation)
LED-3	Indication lamp (Red-Inspection)
PIS	Motion sensor
SW2	Remote control communication address
SW5	Plural units Master / Slave setting
SW6	Model capacity setting
SW7-1	Operation check, drain pump motor test run
TB1	Terminal block (Power source) (□mark)
TB2	Terminal block (Signal line) (□mark)
Thc	Temperature sensor (Remote control)
Th-A	Temperature sensor (Return air)
Th-R1,2,3	Temperature sensor (Heat exchanger)
■mark	Closed-end connector

Color Marks	Color
BK	Black
BL	Blue
RD	Red
WH	White
YE	Yellow
YE/GN	Yellow / Green

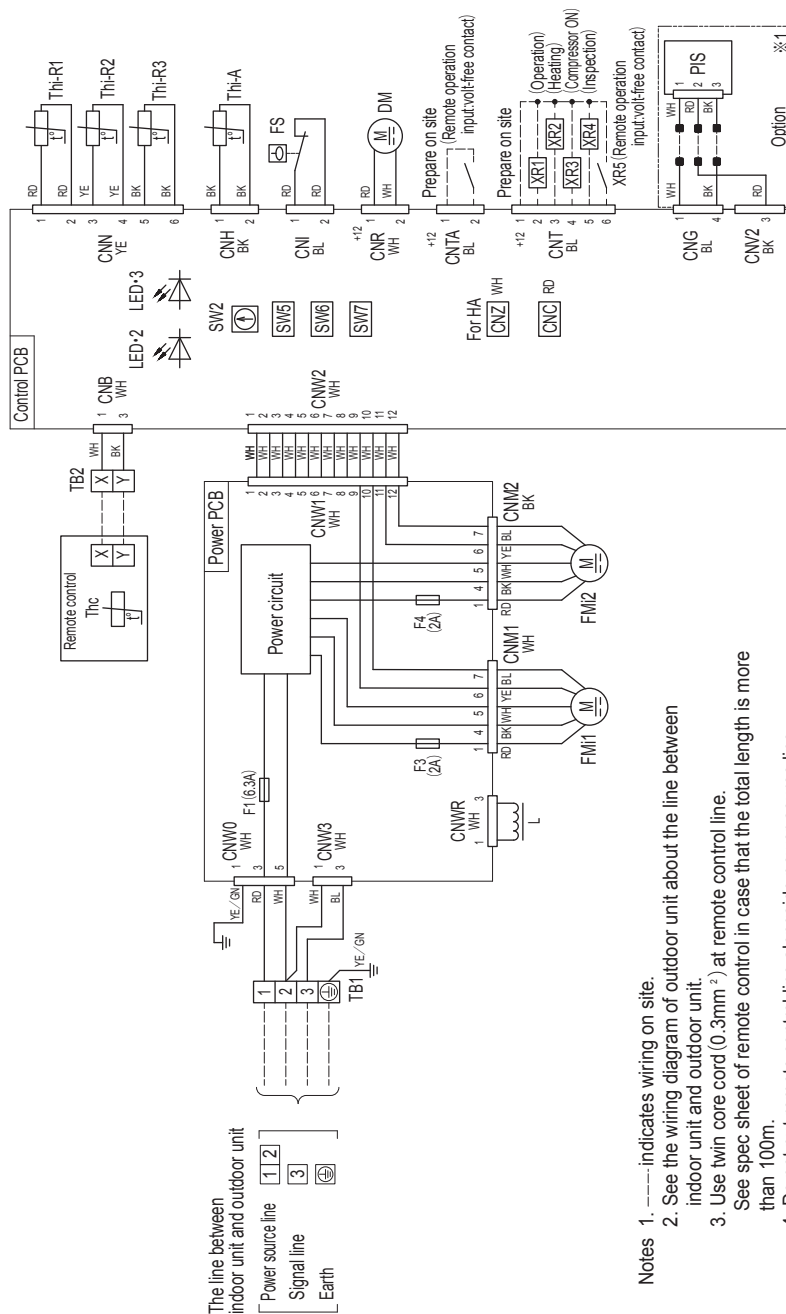

- Notes
1. --- indicates wiring on site.
  2. See the wiring diagram of outdoor unit about the line between indoor unit and outdoor unit.
  3. Use twin core cord (0.3mm<sup>2</sup>) at remote control line. See spec sheet of remote control in case that the total length is more than 100m.
  4. Do not put remote control line alongside power source line.
  5. Section 1 (※1) shows electric circuit of motion sensor (Option).

PJG000Z580

(c) Duct connected-Low / Middle static pressure type (FDUM)  
 Model FDUM100VH

Meaning of marks

Item	Description
CNB-Z	Connector
DM	Drain pump motor
F1,3,4	Fuse
FMI1,2	Fan motor
FS	Floot switch
L	Reactor
LED-2	Indication lamp (Green-Normal operation)
LED-3	Indication lamp (Red-Inspection)
PIS	Motion sensor
SW2	Remote control communication address
SW5	Plural units Master / Slave setting
SW6	Model capacity setting
SW7-1	Operation check/drain pump motor test run
TB1	Terminal block (Power source) (□ mark)
TB2	Terminal block (Signal line) (□ mark)
Thc	Temperature sensor (Remote control)
Thi-A	Temperature sensor (Return air)
Thi-R1,2,3	Temperature sensor (Heat exchanger)
■ mark	Closed-end connector

Color Marks

Mark	Color
BK	Black
BL	Blue
BR	Brown
OR	Orange
RD	Red
WH	White
YE	Yellow
YE/GN	Yellow / Green

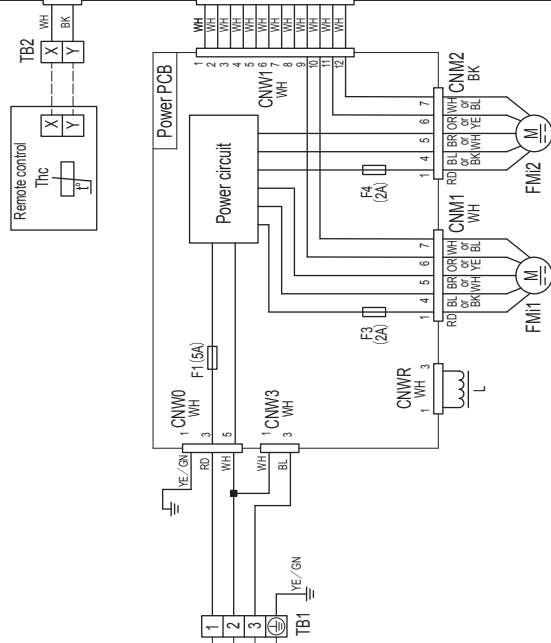
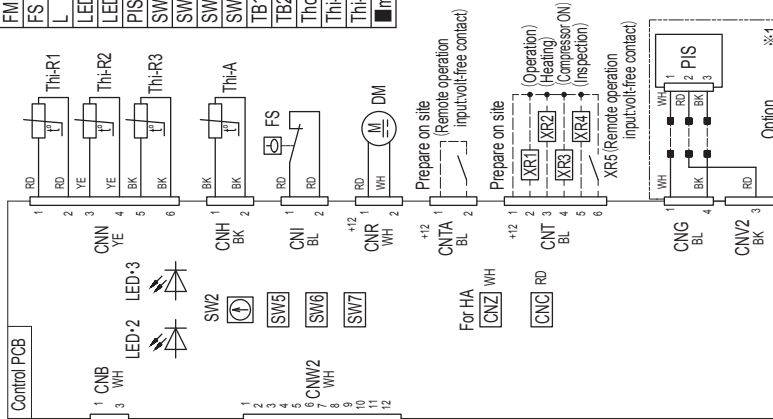

The line between indoor unit and outdoor unit

Power source line	1   2
Signal line	3
Earth	⊕

- Notes
1. ----- indicates wiring on site.
  2. See the wiring diagram of outdoor unit about the line between indoor unit and outdoor unit.
  3. Use twin core cord (0.3mm<sup>2</sup>) at remote control line. See spec sheet of remote control in case that the total length is more than 100m.
  4. Do not put remote control line alongside power source line.
  5. Section 1 (※1) shows electric circuit of motion sensor (Option).

PJG000Z490



(d) Ceiling suspended type (FDE)  
Model FDE100VH

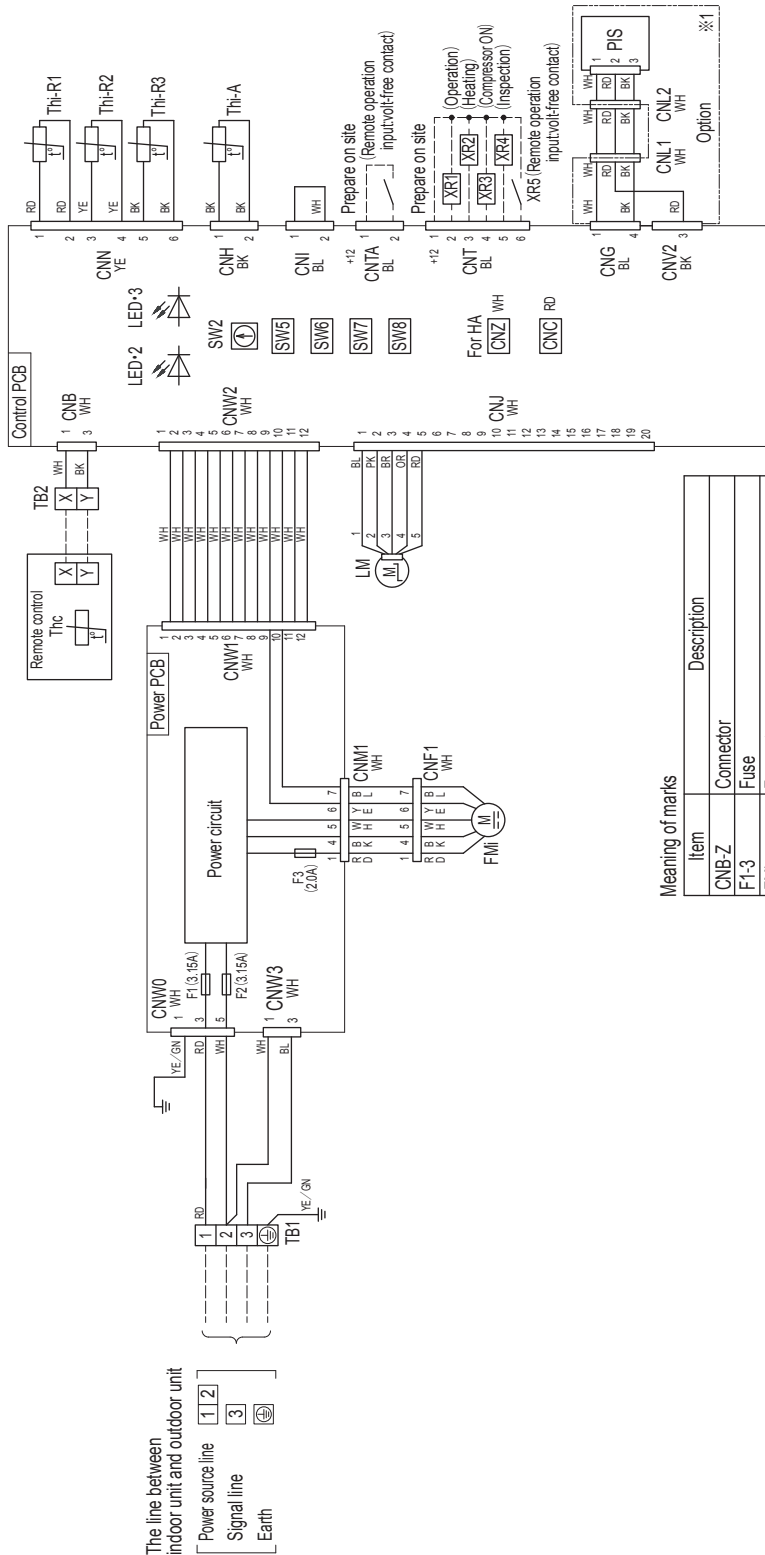

Color marks

Mark	Color
BK	Black
BL	Blue
BR	Brown
OR	Orange
PK	Pink
RD	Red
WH	White
YE	Yellow
YE/GN	Yellow/Green

Meaning of marks

Item	Description
CNB-Z	Connector
F1-3	Fuse
FMi	Fan motor
L	Reactor
LED-2	Indication lamp (Green-Normal operation)
LED-3	Indication lamp (Red-Inspection)
LM	Louver motor
PIS	Motion sensor
SW2	Remote control communication address
SW5	Plural units Master/ Slave setting
SW6	Model capacity setting
SW7-1	Operation check drain pump motor test run
SW8-1	Anti-freeze control
TB1	Terminal block (Power source) (□mark)
TB2	Terminal block (Signal line) (□mark)
Thc	Temperature sensor (Remote control)
Thi-A	Temperature sensor (Return air)
Thi-R1,2,3	Temperature sensor (Heat exchanger)

- Notes
1. --- indicates wiring on site.
  2. See the wiring diagram of outdoor unit about the line between indoor unit and outdoor unit.
  3. Use twin core cord (0.3mm<sup>2</sup>) at remote control line.  
See spec sheet of remote control in case that the total length is more than 100m.
  4. Do not put remote control line alongside power source line.
  5. Section 1 (※1) shows electric circuit of motion sensor (Option).

PFA004Z087

(e) Wall mounted type (SRK)  
Model SRK100ZR-W

Item	Description
CNE	Connector
CNF	
CNG	
CNM	
CNS	
CNU	
CNX	
CNY	
FMi	Fan motor
SM <sub>1</sub>	Flap motor
LM <sub>1,2</sub>	Louver motor
Th <sub>1</sub>	Room temperature sensor
Th <sub>2,1,2</sub>	Heat exchanger temperature sensor
Th <sub>3</sub>	Humidity sensor
DS	Diode stack
F	Fuse
TB	Terminal block
Va	Varistor

Mark	Color
BK	Black
BL	Blue
RD	Red
WH	White
Y	Yellow
Y/G	Yellow / Green

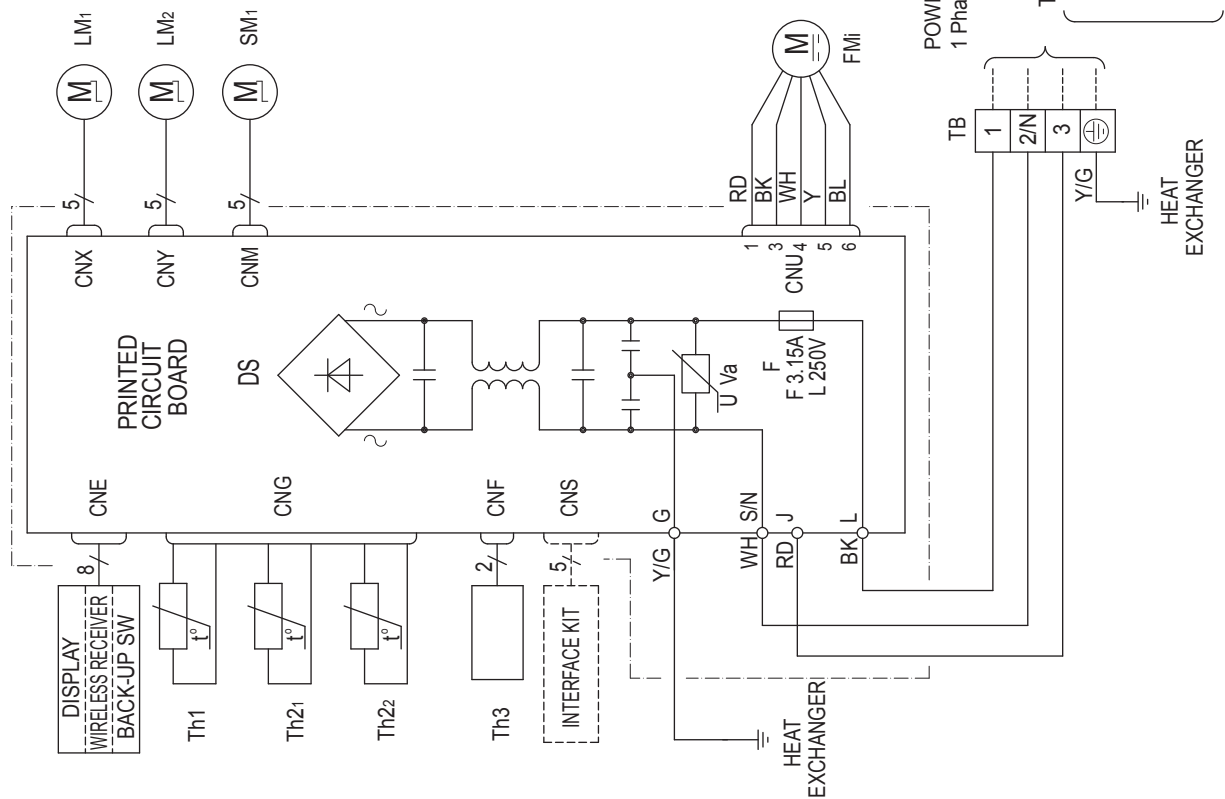

RWA000Z417A

(2) Outdoor units  
Models FDC90VNP-W, 100VNP-W

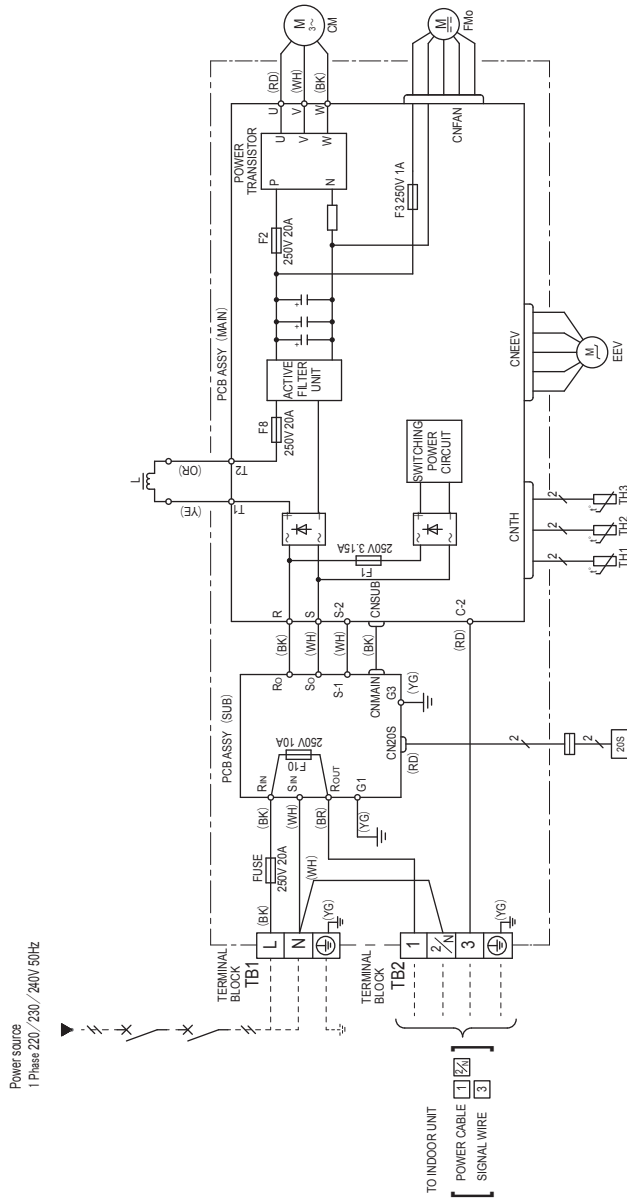

Power cable, indoor-outdoor connecting wires

Model	MAX running current (A)	Power cable size (mm <sup>2</sup> )	Power cable length (m)	Indoor-outdoor wire size x number	Earth wire size (mm <sup>2</sup> )
90, 100	18	2.5	15	1.5mm <sup>2</sup> x 4	1.5

- The specifications shown in the above table are for units without heaters. For units with heaters, refer to the installation instructions or the construction instructions of the indoor unit.
- Switchgear of circuit breaker capacity which is calculated from MAX. over current should be chosen along the regulations in each country.
- The cable specifications are based on the assumption that a metal or plastic conduit is used with no more than three cables contained in a conduit and a voltage drop is 2%. For an installation falling outside of these conditions, please follow the internal cabling regulations. Adapt it to the regulation in effect in each country.

Meaning of marks

Item	Description
CM	Compressor motor
CN20S	Connector
CNTH	Heat exchanger temperature sensor (outdoor unit)
CNEEV	Outdoor air temperature sensor
CNFAN	Discharge pipe temperature sensor
EEV	Solenoid coil for 4-way valve
FMo	Electric expansion valve (coil)
L	Fan motor
TB1.2	Reactor
TH1	Terminal block
TH2	Heat exchanger temperature sensor (outdoor unit)
TH3	Outdoor air temperature sensor
20S	Discharge pipe temperature sensor

Color marks

Mark	Color
BK	Black
BR	Brown
OR	Orange
RD	Red
WH	White
YE	Yellow
YG	Yellow Green

PCA001Z876

# 4. PIPING SYSTEM

Model 90, 100

(1) FDT,FDU,FDUM,FDE series

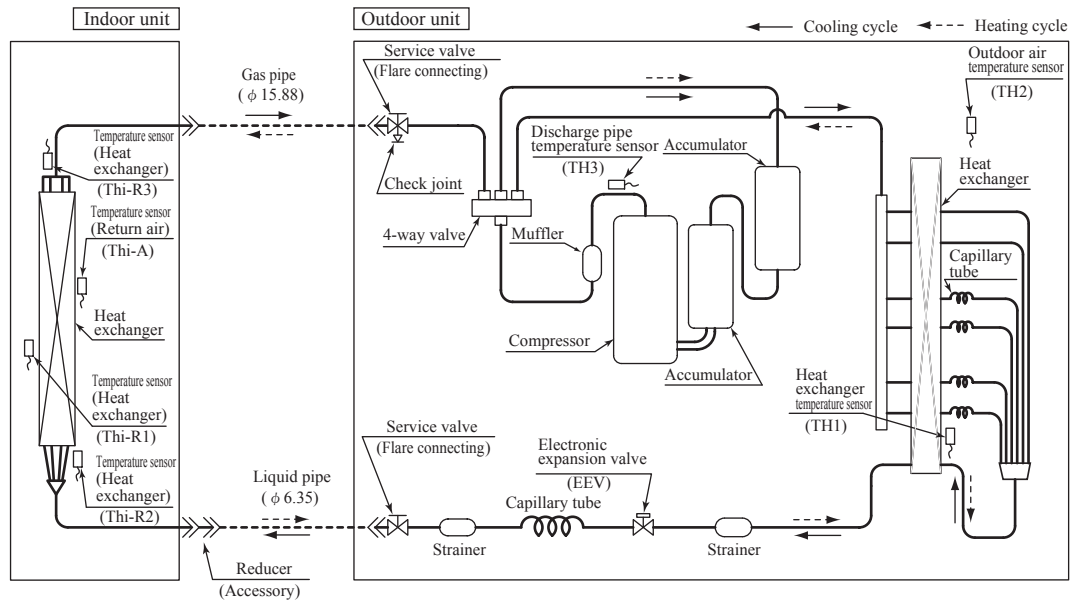

## Preset point of the protective devices

Parts name	Mark	Equipped unit	FDT,FDU,FDUM,FDE series
Temperature sensor (for protection overloading in heating)	Thi-R1 or Thi-R2	Indoor unit	OFF 63°C , ON 56°C
Temperature sensor (for frost prevention)			OFF 1.0°C , ON 10°C
Temperature sensor (for protection high pressure in cooling)	TH1	Outdoor unit	OFF 63°C , ON 50°C
Temperature sensor (for detecting discharge pipe temperature)	TH3		OFF 115°C , ON 95°C

(2) SRK series

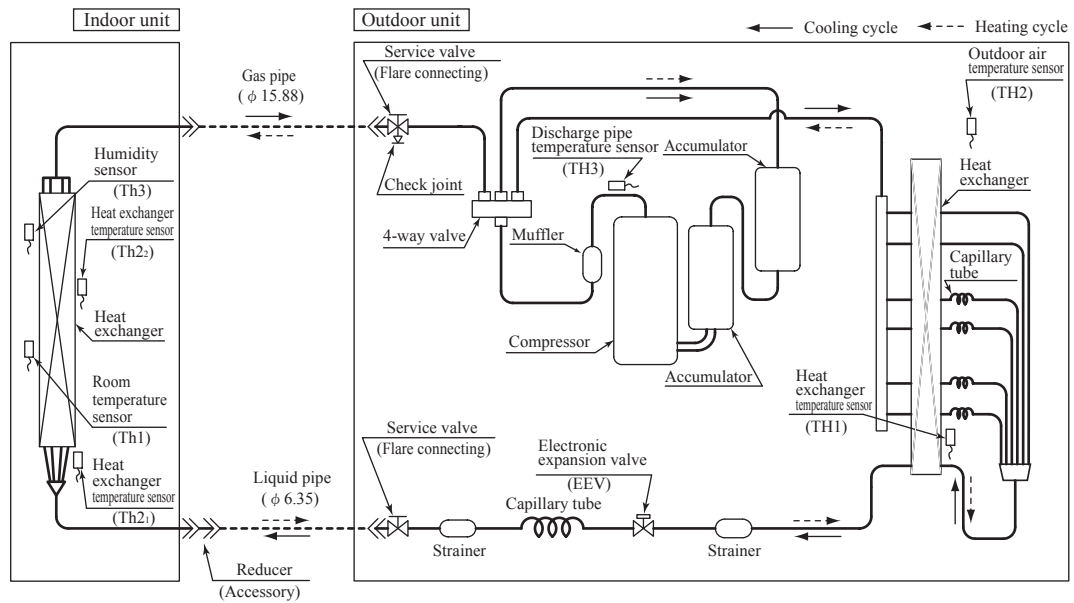

Preset point of the protective devices

Parts name	Mark	Equipped unit	SRK series
Temperature sensor (for protection overloading in heating)	Th2 <sub>1</sub> or Th2 <sub>2</sub>	Indoor unit	OFF 51.5-58°C , ON 48.5°C
Temperature sensor (for frost prevention)			OFF 2.5°C , ON 8°C
Temperature sensor (for protection high pressure in cooling)	TH1	Outdoor unit	OFF 63°C , ON 50°C
Temperature sensor (for detecting discharge pipe temperature)	TH3		OFF 115°C , ON 95°C

---

# **STANDARD INVERTER PACKAGED AIR-CONDITIONERS**

---



---

**MITSUBISHI HEAVY INDUSTRIES THERMAL SYSTEMS, LTD.**

2-3, Marunouchi 3-chome, Chiyoda-ku, Tokyo, 100-8332, Japan  
<http://www.mhi-mth.co.jp/en/>

Because of our policy of continuous improvement, we reserve the right to make changes in all specifications without notice.

© Copyright MITSUBISHI HEAVY INDUSTRIES THERMAL SYSTEMS, LTD.