

# Inverter Packaged Air Conditioners

## **FD** series

High Performance Air Conditioning

# 2023



FDT 4 way



FDTC 4 way compact



Fine snow panel



Shadow black panel



# Inverter Packaged Air Conditioners

## **FD** High Performance Air Conditioning *series*

The PAC range from Mitsubishi Heavy Industries Thermal Systems is ideal for air conditioning in offices, shops, restaurants, and bars, as well as other commercial environments. The versatility of the PAC range, offers you a wide selection of models in function of your installation needs. The modern and attractive design of our indoor units is harmoniously integrated into any atmosphere creating a pleasant and relaxing environment.

### Contents

<b>Product Information</b>	<b>4</b>
<b>Product Line Up</b>	<b>14</b>
<b>Outdoor Units</b>	<b>16</b>
<b>Indoor Units</b> Benefits Summary	<b>22</b>
<b>FDT</b> Ceiling Cassette -4way-	<b>24</b>
<b>FDTC</b> Ceiling Cassette -4way compact-	<b>42</b>
<b>FDU</b> Duct Connected -High Static Pressure-	<b>50</b>
<b>FDUM</b> Duct Connected -Low/Middle Static Pressure-	<b>60</b>
<b>SRK</b> Wall Mounted	<b>74</b>
<b>FDE</b> Ceiling Suspended	<b>82</b>
<b>FD</b> Floor Standing	<b>96</b>
<b>Outdoor Unit Dimensions</b>	<b>105</b>
<b>Control Systems</b>	<b>110</b>
<b>Air Handling Unit Interface</b>	<b>112</b>
<b>Energy efficient and environmentally conscious</b>	<b>116</b>



# Next Generation Refrigerant R32

All indoor units and outdoor units line up are available for R32 refrigerant



FDT



FDTC



FDU



FDUM



SRK



FDE



FDV

## F-GAS REGULATION (EU) No 517/2014

Introduced in January 2015 to regulate the use of Fluorinated Greenhouse Gases (F-Gases)

The Hydrofluorocarbons (HFCs) are F-Gases used in the HVACR sector (Heating, Ventilation, Air Conditioning and Refrigeration)

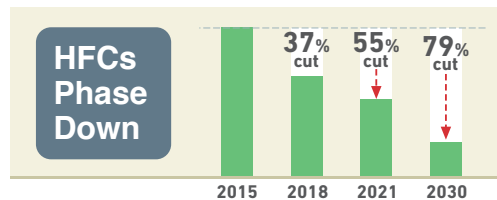

### OBJECTIVE

To protect the environment by reducing the F-Gases emissions

### IMPACT ON HFCs(in EU)

HFCs Phase Down  
HFCs Ban

### SOLUTIONS

- Use lower GWP\* refrigerants in new equipment
- Use high-efficiency equipment with less refrigerant charge
- Check refrigerant leaks regularly

\* GWP is the Global Warming Potential of a refrigerant, representing how much heat an F-Gas traps in the atmosphere

### HFCs Ban

2020

GWP  $\geq$  150  
Portable room air conditioner

GWP  $\geq$  2500  
Stationary refrigeration\*<sup>1</sup>  
(except  $<$  -50°C)

GWP  $\geq$  2500  
Commercial hermetically sealed refrigerators, freezers

2022

GWP  $\geq$  150  
Commercial multipack centralised refrigeration

GWP  $\geq$  150  
Commercial hermetically sealed refrigerators, freezers

2025

GWP  $\geq$  750  
Single Split Fixed Air Conditioning  $<$  3kg HFC

\*1 Stationary refrigeration equipment, that contains or relies its functions upon, HFCs with GWP of 2500 or more except equipment intended for application designed to cool products to temperatures below -50°C application



LOWER GWP + LESS REFRIGERANT CHARGE = LOWER HFCs EMISSIONS

# R32 - A Low GWP Refrigerant

- A single component, easy to handle refrigerant
- Known as a component of the blend R410A(50% R32, 50% R125)
- Already used in Air Conditioning systems worldwide
- Zero Ozone Depletion
- Superior Energy Efficiency vs. R410A
- Reduced refrigerant charge vs. R410A
- Easy to recycle



**Hyper Inverter**

**Micro Inverter**

**Standard Inverter**

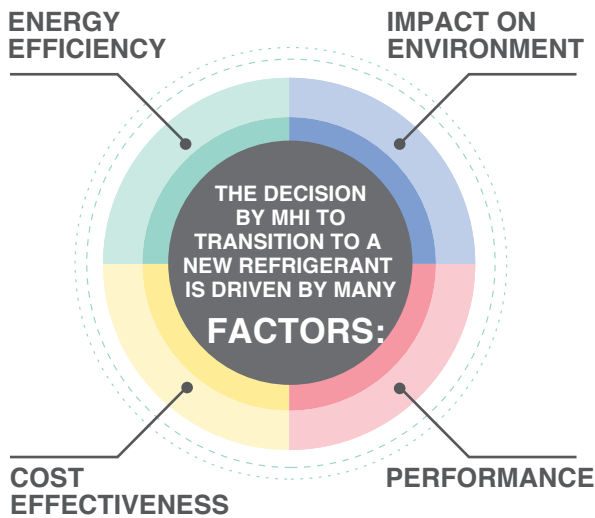

## Low Global Warming Potential

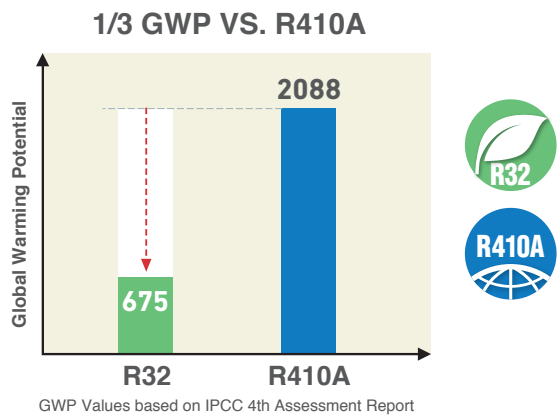

## Improved Energy Efficiency

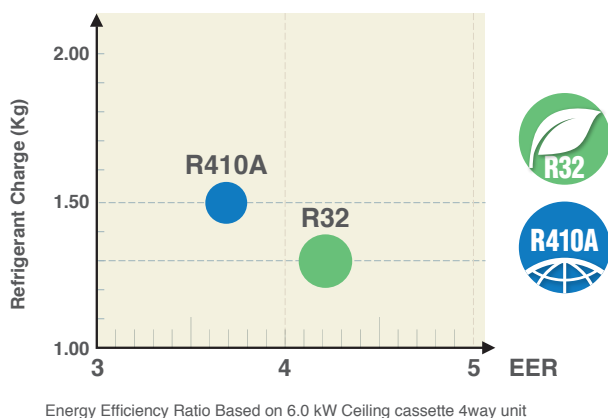

## Reduced Refrigerant Charge

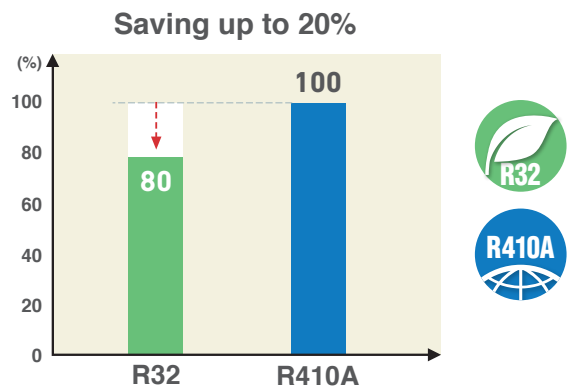

# New Generation

Ceiling Cassette  
4way

# FDT



- Automatic energy saving control
- Keep maximum comfort with minimal draft
- Quiet operation

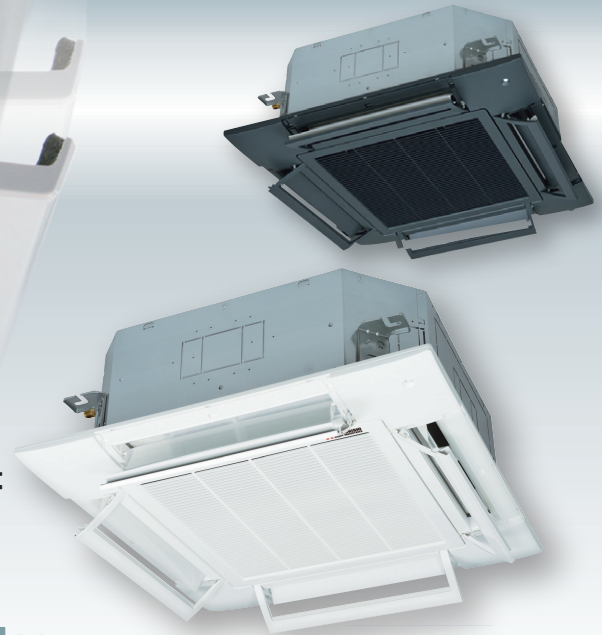

## High energy efficiency with new technology

FDT can achieve higher seasonal efficiency by utilising Mitsubishi Heavy Industries latest technology.

● SEER and SCOP is defined in European regulations. Please refer to P112.

**SEER in cooling** ■ Previous(VG(R410A)) ■ New(VH(R32))

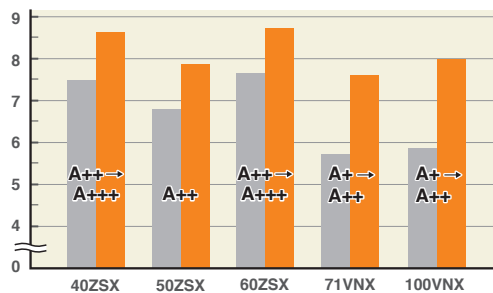

**SCOP in heating** ■ Previous(VG(R410A)) ■ New(VH(R32))

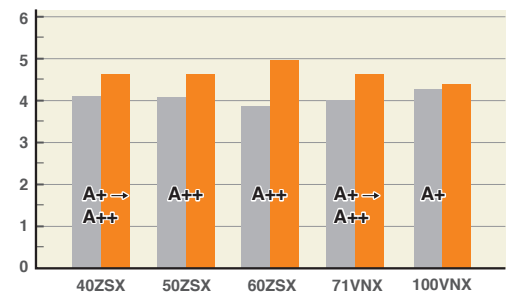

## Quieter noise & Improved aerodynamic performance of the unit

New technology achieved low noise while keeping capacity and comfort by reducing the pressure fluctuation in an indoor unit. A fan guard ensures both safety and quietness.

Turbo fan



Fan guard (standard equipment)



New

## Various panels available

You can choose white and black panel according to the atmosphere and purpose of the room.



White panel (Fine snow)



Black panel (Shadow black)

## New flexible flap control for draft prevention



### Draft Prevention Panel (Option)

Each of the 4 flaps can be controlled individually at each operation mode. They change air flow direction and prevent drafts occurring. This function also provides flexible control of air flow direction.



### Motion Sensor (Option)

Motion sensor (option) detects human activity. Energy saving control is achieved by shifting set temperature according to detected amount of activity.

Ceiling Cassette  
4way compact

# FDTC



- More comfort and Higher energy savings
- European design
- Lower noise



A' Design Award and Competition is the World's largest, most prestigious and influential design accolade, the highest achievement in design. A' Design Award Winner Logo, symbolizes exceptional design excellence in products, projects and services.

## European Design & Flat Panel



## New Various panels available

You can choose the grill design according to the atmosphere and purpose of the room.



Integrated Ceiling System Design(600×600)

## Draft Prevention Panel and Motion Sensor (option)

Draft prevention panel and motion sensor are available on FDTC, just like on FDT.

Floor standing



# FDF

- New floor standing unit compatible with R32
- Increased Energy efficiency
- R32 leak detector built-in



## Improved features

Heat exchanger design optimized for R32 operation. The leak detector device will be integrated at the bottom of the unit. Remote control RC-EX3 upgraded for leak detector functions.



Inside



# Draft Prevention

Keep maximum comfort with minimal draft: FDT & FDTC control flaps with more flexibility.



Ceiling cassette Compact FDTC-VH series



Ceiling cassette FDT-VH series

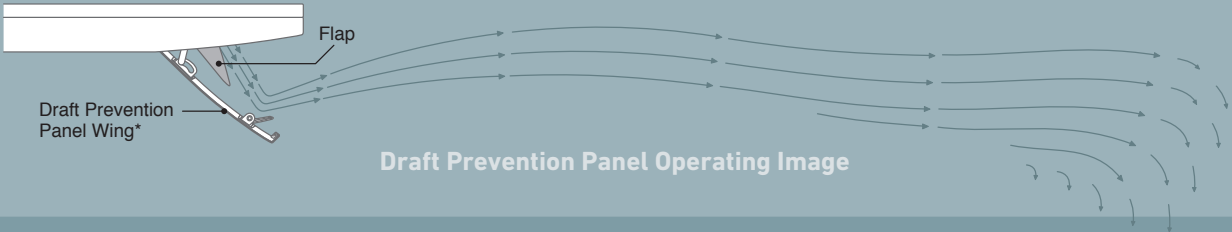

Draft Prevention Panel off

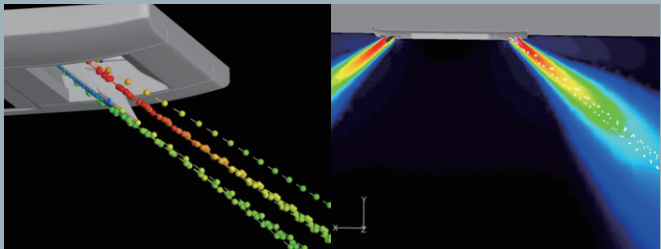

Draft Prevention Panel working \*

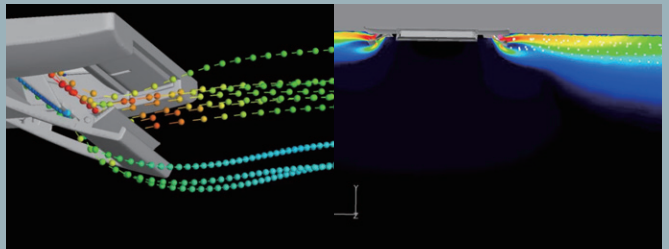

Draft Prevention Panel provides a comfortable airflow without any draft feeling. Whether cooling or heating a room, the remote control can be used to instantly suppress any warm or cool drafts. This accurately assists how air flow is directed out of the indoor unit.

\* Images is for illustration purposes.



# Motion Sensor

## Energy saving operation by detecting human movement

### 3 Step Control

- 1 Power Control** Motion sensor (option) detects human activity. Energy saving control is achieved by shifting set temperature according to detected amount of activity.
- 2 Stand by** Unit will go on stand-by mode when no activity is detected. When the motion sensor detects activity again, the unit will automatically re-start operation.
- 3 Auto Off** Unit will go off automatically when no activity is detected for 12 hours.

Optional for models



FDT



FDTC



FDU



FDUM



FDE



FDF

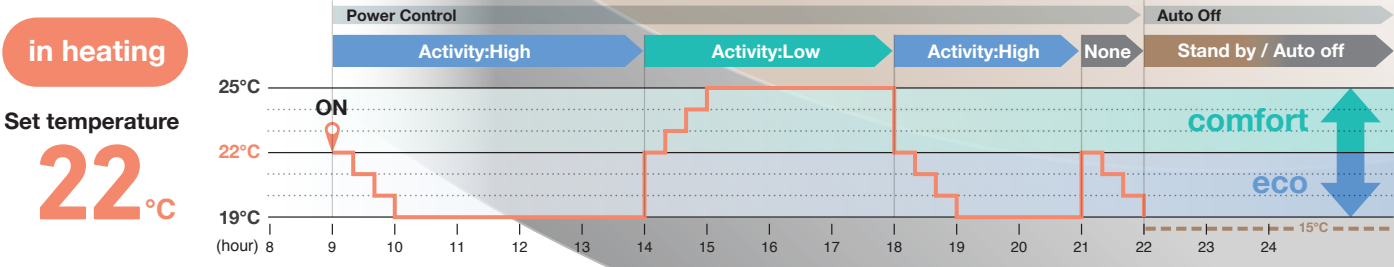
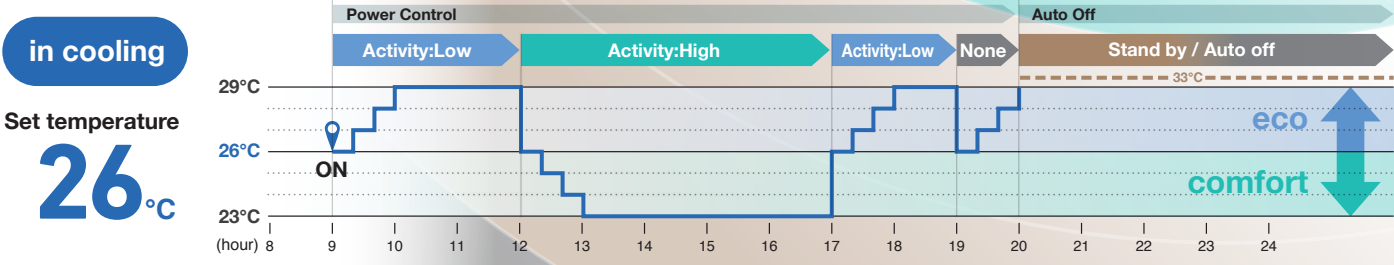
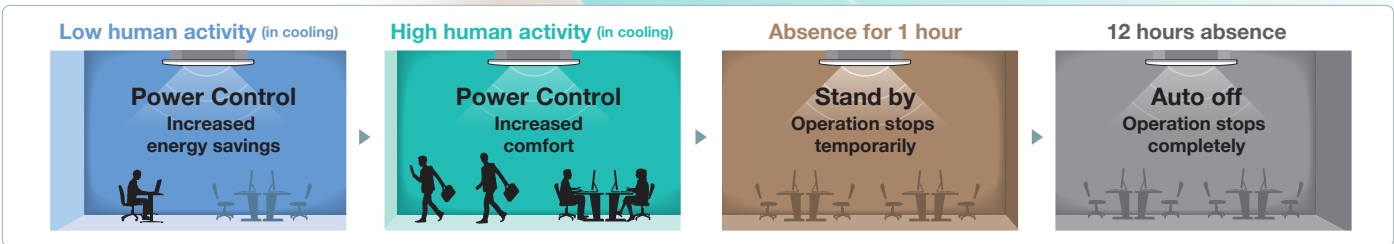

Operation mode and Control of Motion sensor		eco operation		Operation mode				
		comfort operation		Auto	Cool	Heat	Dry	Fan
Power Control *1	Human activity 	Low	Cooling +3°C Heating +3°C	+3°C	+3°C	+3°C	—	—
		High	Cooling -3°C Heating -3°C	-3°C	-3°C	-3°C	—	—
		None	Cooling +3°C Heating -3°C	+3°C	-3°C	-3°C	—	—
Auto Off *2				●	●	●	●	●

\*1 Set temperature is revised maximum ±3°C at Cooling/Heating mode by detecting heat volume movement.

\*2 Absence for 1 hour ⇒ Operation stops ("Stand-by") 12 hours absence ⇒ Operation stops completely

# Remote Control

Simple use with  
advanced settings  
**REMOTE CONTROL**

Intuitive touch controller with  
Liquid Crystal Display

## RC-EX3A



### Function Switch

The function switch allows the user to select preferred two functions that are desired from the seven available functions shown.

These functions can be used by simply pressing the button after they are set, allowing you to use your preferable functions immediately.

#### 1. Draft prevention ON/OFF



Anti draft can be turned ON/OFF with a single tap of the button.

#### 2. High Power Mode



High Power Mode achieve excessive cooling / heating capacity in 15 minutes to quickly adjust the room temperature to a comfortable level.

#### 5. Home Leave Mode



Home leave mode maintains the room temperature at a moderate level.

#### 3. Energy Saving Mode



Temperature is set to be optimized to save energy without losing comfort.

#### 6. Favourite Mode



Operation mode, set temperature, fan speed and air flow direction will automatically be adjusted to the programmed favorite setting.

#### 4. Quiet Mode



Outdoor unit starts to operate quietly by activating this mode. The time of this mode can be set in conjunction with Indoor Silent Timer.

#### 7. Filter Sign



Announces the due time for cleaning the air filter.

### Favourite Mode

Operation mode, set temperature, fan speed and air flow direction are memorized and allocated to two buttons that can be operated by one touch.

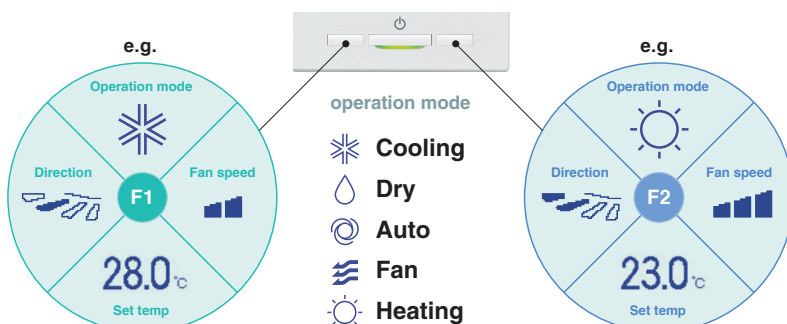

### Adjustable Brightness of the Operation Lamp

The brightness of the operation lamp behind Run/Stop switch can be adjusted by 10 stages.

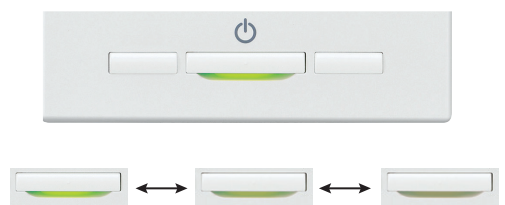

## Draft Prevention Setting

(only FDT•FDTC series)

User can enable/disable the motion of Draft prevention panel for each air outlet for each operation mode. This function can be set while operating.

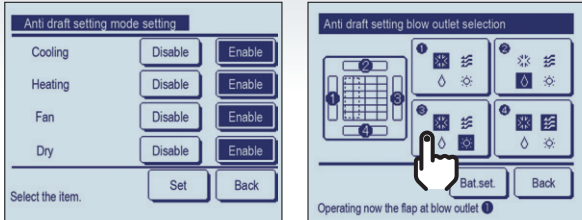

## Easy Adjustment of the Air Flow

User can visually confirm and set the direction of flaps using the visual display on the remote controller.

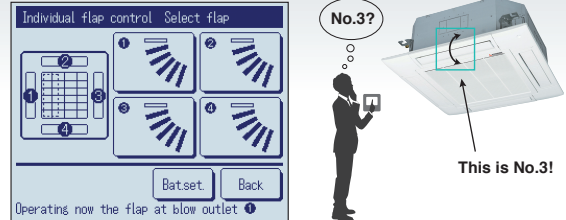

## Motion Sensor Control

Presence of humans and activity are detected by a motion sensor to perform various controls.

### 1 Select Enable / Disable Motion sensor control



Enable/Disable

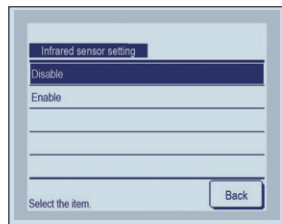

Select **Enable/Disable** for the motion sensor of the indoor unit connected to the R/C.

### 2 Select Enable / Disable per control

- Power control
- Auto-off

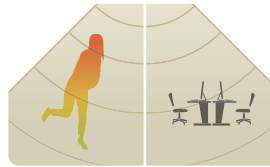

Enable/Disable

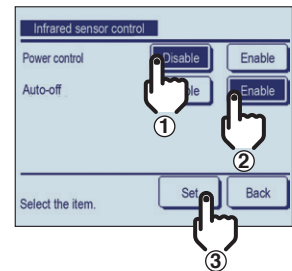

## Backup Control

Control restricted to two indoor units (two groups)



### Fault backup control

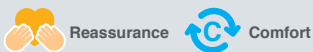

#### Keep back up all the time!

If one of the two indoor units malfunctions and stops its operation, the other starts backup operation so that users' comfort will not be compromised.

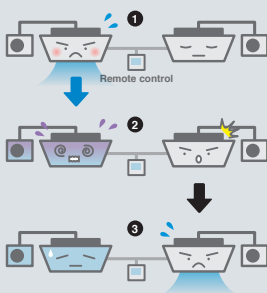

### Capacity backup control



#### Maintains users' comfort!

When the control system detects either of its two units operating with overload, the other unit cover the capacity.

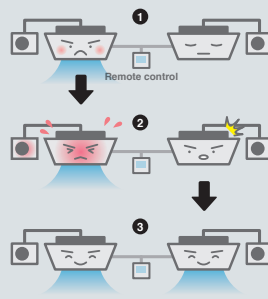

### Rotational operation control



#### Energy saving and longer life!

By operating two indoor units alternately, their chronological changes are equalized. (The alternate operation cycle can be specified in a range from 1 to 999 hours in increments of 1 hours.)

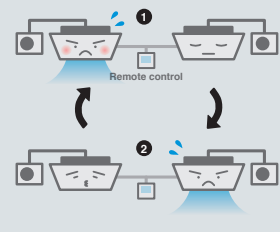

# REMOTE CONTROL

## Additional Functions of External Input / Output

The external input/output of indoor unit by remote controller can set input/output based on user's demand.

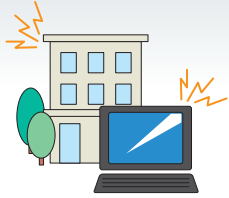

Remote surveillance system



Card key on-off

### External Input

CNT (1-6) CNTA (1-2)

Input On/Off  
Permission/Prohibition  
Cooling/Heating  
Emergency Stop

Set temp. shift  
Forced thermo-off  
IU operation stop  
Silent mode

Newly added

### External Output

CNT (New)

2 Output - Operation  
- Heating  
- Compressor ON (thermo-ON)

3 Output - Inspection

Cooling (defrosting)  
- Fan operation  
- Fan operation with Phi or Hi  
- Fan operation with Me or Lo  
- Defrosting (oil return in heating operation)  
- Ventilation  
- Heater ON  
- Free cooling  
- IU overload alarm

Newly added

## Silent Mode Control

The Outdoor unit is controlled prioritising quiet operation. Silent mode control must be set to the F1 or F2 switch. User can start/stop the silent mode control with a single tap of a button.

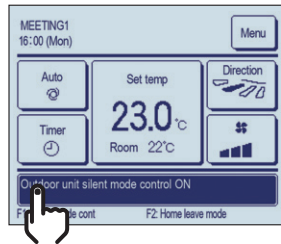
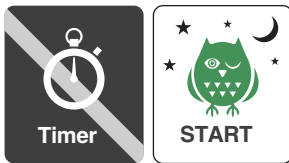

## Indoor Unit Capacity Display

Capacities of Indoor units connected to the RC-EX3A are displayed.

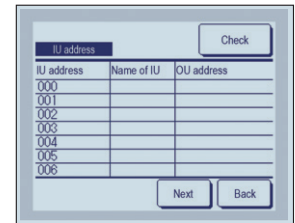
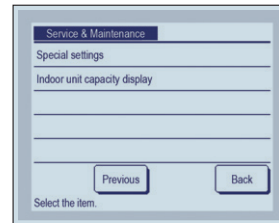

## Language Switching

User can select from the following languages and also switch them on the top display.

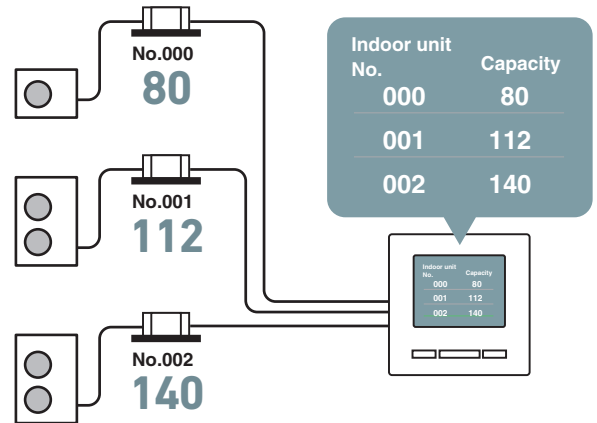
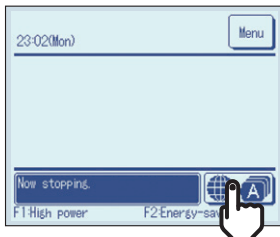

## Error display

If any error occurs on the air conditioner, the "Unit protection stop" is indicated on the message display.



"Error"

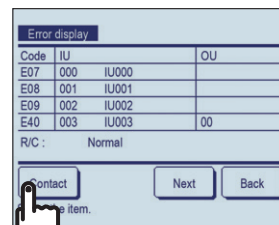
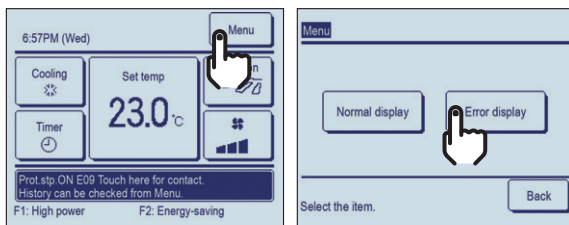

# Case Study : Commercial

Specific cases of FD series installation from Mitsubishi Heavy Industries Thermal Systems

## MHI aircon system recovers waste energy at Bristol Airport

A 375kW air conditioning installation from Mitsubishi Heavy Industries Thermal Systems has just checked in at Bristol Airport. Twenty multi-split systems from MHI's FD Micro Inverter range and 33 SAF fresh air heat exchange units service a hub of pre-boarding and arrivals areas plus a new two-storey walkway connection to the terminal building. MHI's FD Split and Multi Split Systems feature a cutting edge inverter controlled compressor that adjusts automatically to meet the precise demands of the indoor unit to save energy and reduce temperature fluctuations.

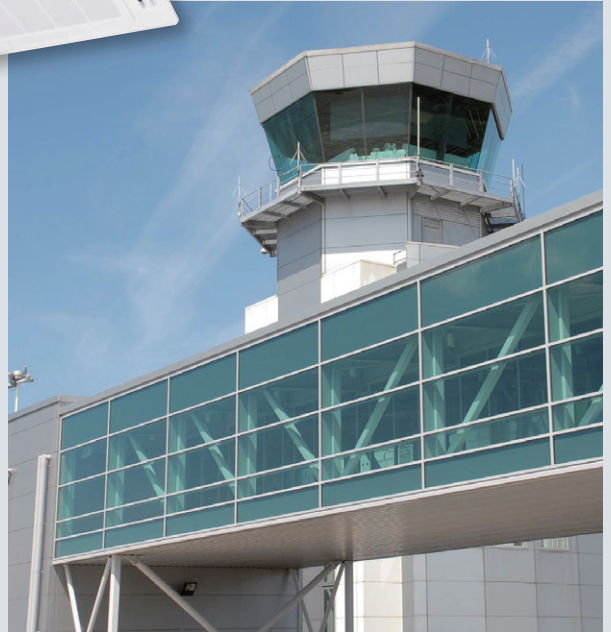









## MHI aircon system offers bowling centres energy savings of up to 38%

High efficiency climate control from Mitsubishi Heavy Industries Thermal Systems has scored a strike at The Original Bowling Company, the UK's number one ten pin bowling operator. Outdated heating and cooling plant has been replaced with Mitsubishi Heavy Industries Thermal Systems heat pump systems at four Hollywood Bowl and AMF Bowling Centres so far, with further sites to follow in an ongoing refurbishment programme. The new systems employ MHI's inverter technology offering variable capacity control for consistent temperatures and energy savings of up to 38%.



# Product line up



## SINGLE SPLITS

FD series Type		Hyper Inverter 						
		HP	1.5	2.0	2.5	3.0	4.0	
		kW	4.0	5.0	6.0	7.1	10.0	
		Btu/h	13,600	17,100	20,500	24,200	34,100	
		kcal/h	3,440	4,300	5,160	6,100	8,600	
Ceiling Cassette	<b>FDT</b> P24 4way New 	R32	1 Phase	●	●	●	●	●
			3 Phase					●
		R410A	1 Phase	●	●	●	●	●
			3 Phase					●
	<b>FDTC</b> P42 4way compact New 	R32	1 Phase	●	●	●		
			3 Phase					
R410A		1 Phase	●	●	●			
		3 Phase						
Duct Connected	<b>FDU</b> P50 High Static pressure New 	R32	1 Phase				●	●
			3 Phase					●
		R410A	1 Phase				●	●
			3 Phase					●
	<b>FDUM</b> P60 Low/Middle Static pressure 	R32	1 Phase	●	●	●	●	●
			3 Phase					●
R410A		1 Phase	●	●	●	●	●	
		3 Phase					●	
Wall Mounted	<b>SRK</b> P74 New 	R32	1 Phase				●	●
			3 Phase					●
		R410A	1 Phase					
			3 Phase					
Ceiling Suspended	<b>FDE</b> P82 	R32	1 Phase	●	●	●	●	●
			3 Phase					●
		R410A	1 Phase	●	●	●	●	●
			3 Phase					●
Floor Standing	<b>FDF</b> P96 New 	R32	1 Phase				●	●
			3 Phase					●
		R410A	1 Phase				●	●
			3 Phase					●



Combat Global Warming  
Please refer to Page 4

Capacity Range (Nominal Cooling Capacity)

		New Micro Inverter 						New Standard Inverter 			
5.0	6.0	4.0	5.0	6.0	8.0	10.0	12.0	3.0	3.5	4.0	5.0
12.5	14.0	10.0	12.5	13.6	20.0	25.0	27.0	7.1	9.0	10.0	12.1
42,700	47,800	34,100	42,700	46,400	68,200	85,300	92,100	24,200	30,700	34,100	41,300
10,750	12,040	8,600	10,750	11,690	17,200	21,500	23,200	6,100	7,740	8,600	10,404
●	●	●	●	●				●	●	●	●
●	●	●	●	●							
●	●	●	●	●				●	●	●	
●	●	●	●	●							
●	●	●	●	●				●	●	●	●
●	●	●	●	●	●	●	●				
●	●	●	●	●				●	●	●	
●	●	●	●	●	●	●					
●	●	●	●	●				●	●	●	●
●	●	●	●	●							
●	●	●	●	●				●	●	●	
●	●	●	●	●							
		●						●		●	
		●									
		●								●	
		●									
●	●	●	●	●				●	●	●	●
●	●	●	●	●							
●	●	●	●	●				●	●	●	
●	●	●	●	●							
●	●	●	●	●				●	●	●	
●	●	●	●	●							
●	●	●	●	●							
●	●	●	●	●							
●	●	●	●	●							

# Outdoor units

Our new advanced technology has high efficiency, strong heating and long piping. This contributes to the environmental protection through energy saving and permits installation of the units (4-6HP) considering a heating operation under temperature conditions down to -20°C. The Standard Inverter series offer optimised efficiency at a reasonable cost.

## Line up

HP	1.5	2	2.5	3	3.5	4	5	6	8	10	12
Hyper Inverter	●	●	●	●	-	●	●	●	-	-	-
Micro Inverter	-	-	-	-	-	●	●	●	●	●	●
Standard Inverter	-	-	-	●	●	●	●	-	-	-	-

## Hyper Inverter



SRC40ZSX-W1 (1.5HP)  
SRC50ZSX-W2 (2.0HP)  
SRC60ZSX-W1 (2.5HP)



FDC71VNX-W (3.0HP)



FDC100VNX/VSX-W (4.0HP)  
FDC125VNX/VSX-W (5.0HP)  
FDC140VNX/VSX-W (6.0HP)



SRC40ZSX-S (1.5HP)  
SRC50ZSX-S (2.0HP)  
SRC60ZSX-S (2.5HP)



FDC71VNX (3.0HP)



FDC100VNX/VSX (4.0HP)  
FDC125VNX/VSX (5.0HP)  
FDC140VNX/VSX (6.0HP)

## Micro Inverter



FDC100VNA-W/VSA-W (4.0HP)  
FDC125VNA-W/VSA-W (5.0HP)  
FDC140VNA-W/VSA-W (6.0HP)

New



FDC200VSA-W (8.0HP)  
FDC250VSA-W (10.0HP)  
FDC280VSA-W (12.0HP)



FDC100VNA/VSA (4.0HP)  
FDC125VNA/VSA (5.0HP)  
FDC140VNA/VSA (6.0HP)



FDC200VSA (8.0HP)



FDC250VSA (10.0HP)

## Standard Inverter



FDC71VNP-W (3.0HP)



FDC90VNP-W (3.5HP)  
FDC100VNP-W (4.0HP)

New



FDC125VNP-W (5.0HP)



FDC71VNP (3.0HP)



FDC90VNP1 (3.5HP)



FDC100VNP (4.0HP)



# High Efficiency

Outdoor units high efficiency levels are achieved thanks to our latest technologies, such as high efficient twin rotary compressors.

## SEER in cooling

■ Previous(VG(R410A)) ■ New(VH(R32))

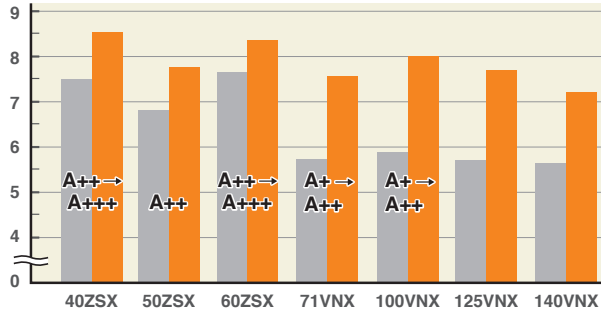

## SCOP in heating

■ Previous(VG(R410A)) ■ New(VH(R32))

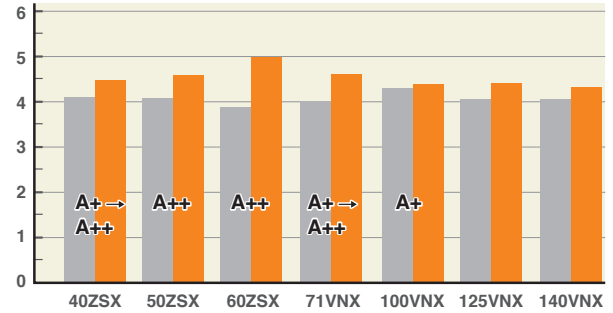

· In case of ceiling cassette 4way unit.

## Our Latest Technologies

### 1 High efficiency performance on the DC twin rotary compressors

Adoption of DC twin rotary compressor has enabled to utilize a high-speed range of up to 120 rps at the maximum to secure the required capacity.



DC twin rotary compressor

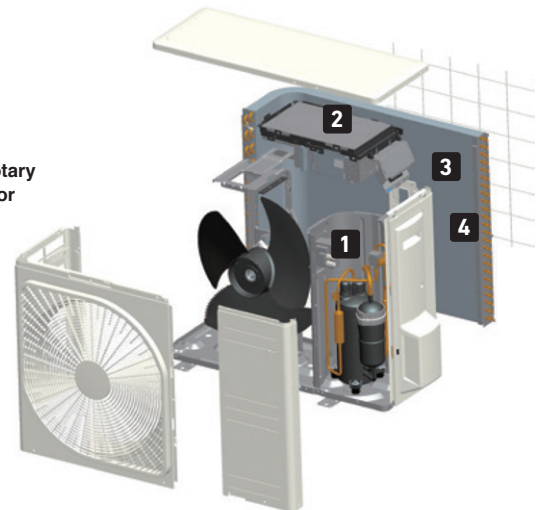

### 2 Vector inverter control

Optimum compressor control has been realized by employing the vector control\* and the starting current has been improved significantly compared with former models. Moreover, vibration has been reduced.

\* Vector control means a technique to realize an optimum control by converting the current wave to a smooth sinusoidal waveform

**Better partial load efficiency**

Distributed winding motor

Centralized winding motor

\* only R32 models

### 3 Heat exchanger

Thanks to changing fin configuration from flat sheet to M shape fin. This high dimensional structure provides optimum balance of heat transfer and airflow.

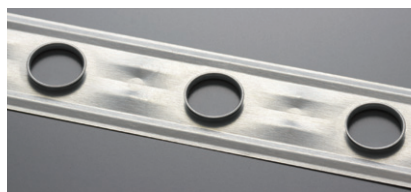

#### sectional structure

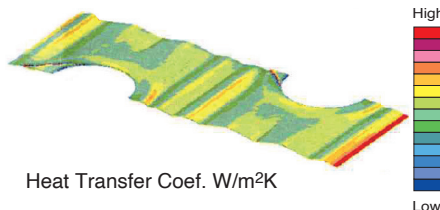

### 4 Blue fin

Due to application of blue coated fins (KS101) on the heat exchanger of the new outdoor unit, corrosion resistance has been improved compared to previous models.

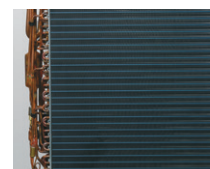

Hyper Inverter	3~6HP
Micro Inverter	4~12HP
Standard Inverter	3.5~5HP

# Outdoor units

## Leading Powerful Heating Capacity

- The maximum heating capacity can be increased by:
- optimizing the refrigerant control and use of the electric expansion valve
  - Utilization of the twin rotary compressors
  - Nominal heating capacity can be reached when outdoor temperature is -8°C
  - Also effective to be used in cold areas

**Hyper Inverter**

Temperature of supply air can reach 40°C in 4 minutes after start up under low temperature operation conditions (at both indoor and outdoor temperature of 2°C) and can reach 50°C in 8 minutes after that.

Heating capacity (in case of 5HP, 3Phase 380V)

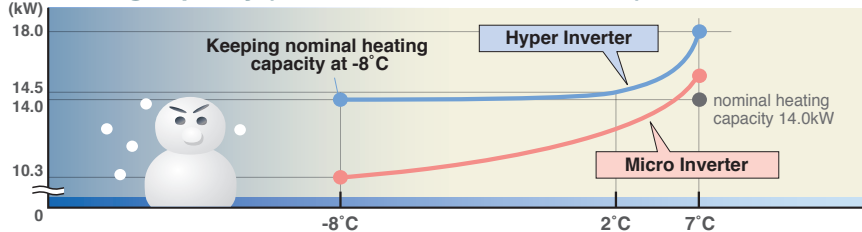

model name	nominal heating capacity (kW at outdoor temperature of 7°C)	heating capacity at outdoor temperature of -8°C
FDC100VSX(4HP, 3Phase 380V)	11.2kW	11.2kW
FDC125VSX(5HP, 3Phase 380V)	14.0kW	14.0kW
FDC140VSX(6HP, 3Phase 380V)	16.0kW	16.0kW

Please refer to our technical manual for installation conditions, operation range and heating/cooling capacities. (including 1Phase 220V)

Heating capacity

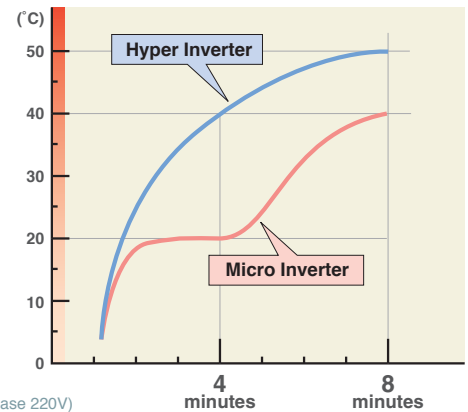

## Wide Range of Operation

Our new advanced technology has expanded the heating and cooling operation range. This permits installation of the units under a low outdoor temperature conditions down to -15°C/-20°C in heating operation and -15°C in cooling operation.

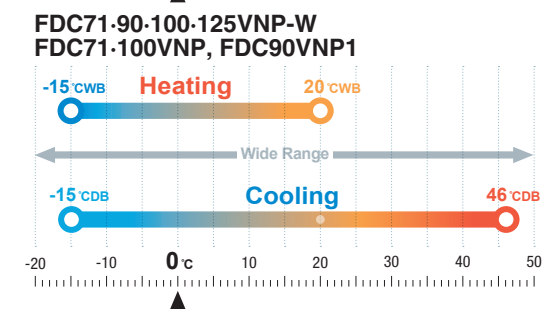
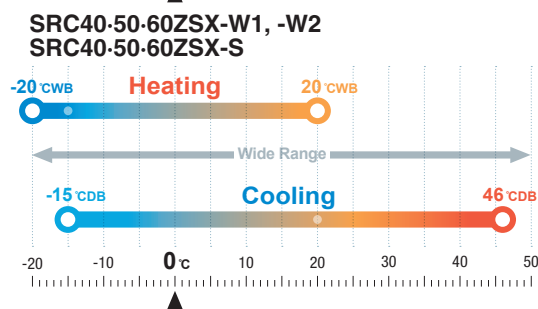
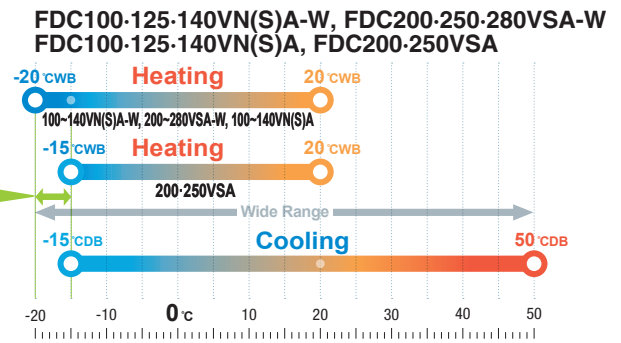
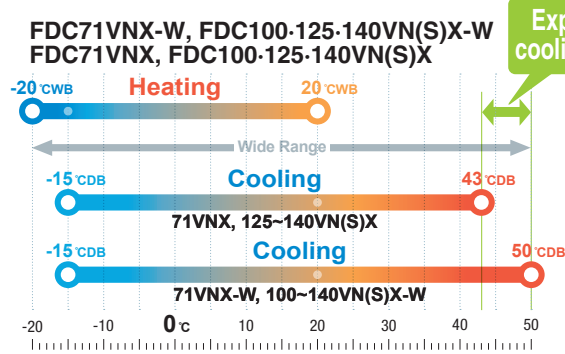

## Silent Mode Operation

**Hyper / Micro Inverter**

Improved "silent mode" is possible, in two steps. ※ Applied on 4-6HP, 8-12HP(R32)

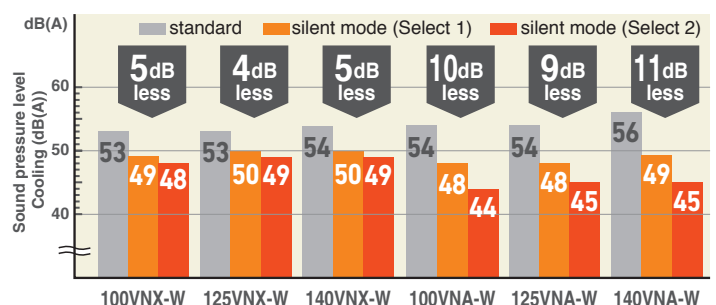
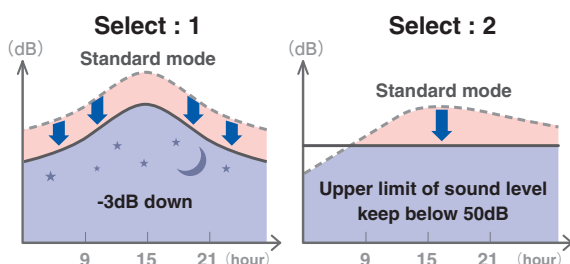

## Installation Workability

Enhanced installation workability thanks to the extended pipe length – longest level in the industry and precharged refrigerant.

### Long piping

(in case of Hyper 4~6HP)

### Wider variation of installation!

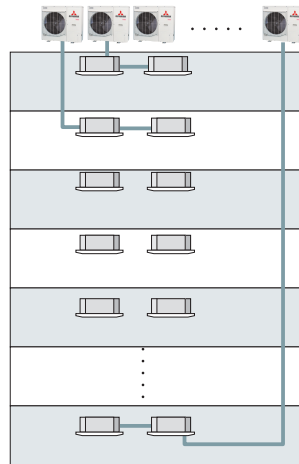
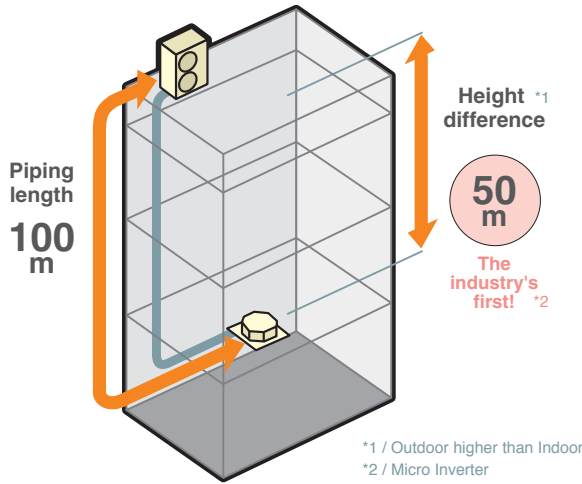

Hyper Inverter		
HP	Piping length	Height difference
1.5 ~ 2.5	30m	20m
3	50m	30m
4~6(R32)	100m	50m
4-6(R410A)	100m	30m

### Micro Inverter

HP	Piping length	Height difference
4 ~ 6	50m	50m *3
8~10(R32)	70m	50m *4
8-10(R410A)	70m	30m
12	60m	50m *4

\*3 When the outdoor unit is installed at a position higher than the indoor unit by 30m or more, set SW5-2 on the control PCB to ON.

\*4 In case of following conditions: Max.50m (Outdoor unit is higher & Outdoor temperature ≤ 43°C), Max.30m (Outdoor unit is higher & Outdoor temperature > 43°C)

### Standard Inverter

HP	Piping length	Height difference
3 ~ 5	30m	20m

### Refrigerant precharged piping length extending to 30m

Refrigerant precharged piping length extends up to 30m. This eliminates the need to add refrigerant on site, which sets it free from trouble of excessive or insufficient charging of refrigerant, and allows carrying out the installation smoothly. • Hyper inverter 1.5~2.5HP and Standard Inverter are up to 15m.

## Serviceability

Micro Inverter (8(R32)-10-12HP)

### Improved freedom of piping layout

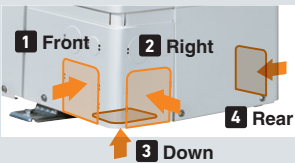

Hole size becomes 120% bigger.

### A transparent rain cover

Attached as a standard for easy maintenance.

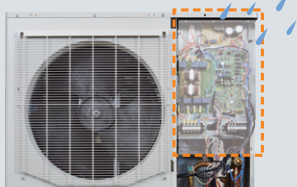

### Wire insertion holes for fall prevention



### 2 Layer Construction

Thanks to control box structure with 2 layer construction using hinge connection, service and maintenance has been made much easier for inverter components.



### Fixing screws to service panel

Decreasing number of screws from 5 to 2, installation & service speed is improved.

## Monitoring Function

All outdoor units

To your PC monitoring and service tasks made simple with our service software ("Mente PC").

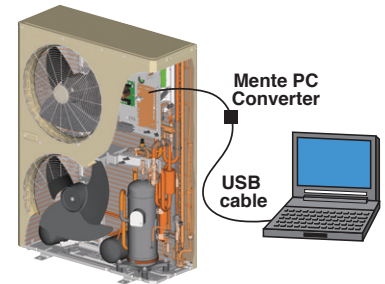

### Base heater kit (Option)

This kit is recommended to be used in an area where the lowest temperature drops below 0°C.



CW-H-E1

## Easy Transportation & Installation

Compact design of outdoor units.

Standard Inverter

FDC100VNP-W

- Compact model
- Reduction of weight



Fits into elevators



Eazy installation



applied for



	R32	R410A
Hyper Inverter	FDC71VNX-W	FDC71VNX
	FDC100·125·140VNX-W	FDC100·125·140VNX
	FDC100·125·140VSX-W	FDC100·125·140VSX
Micro Inverter	FDC100·125·140VNA-W	FDC100·125·140VNA
	FDC100·125·140VSA-W	FDC100·125·140VSA
	FDC200·250·280VSA-W	FDC200·250VSA
Standard Inverter	—	FDC100VNP

# Outdoor units

## ■ MULTI SYSTEM

# Twin / Triple / Double Twin Multi System

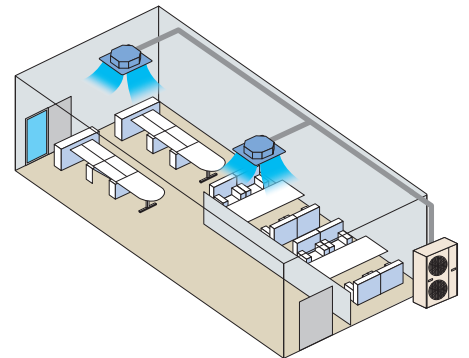

Up to four indoor units can be connected to a single outdoor unit and operated simultaneously with a single remote control. By referring to the following table for applicable indoor units, select the same models and capacities.

### Combination of indoor units

Outdoor Unit		Hyper Inverter				Micro Inverter						
FDC		71VNX-W	100VNX-W 100VSX-W	125VNX-W 125VSX-W	140VNX-W 140VSX-W	100VNA-W 100VSA-W	125VNA-W 125VSA-W	140VNA-W 140VSA-W	—	200VSA-W	250VSA-W	280VSA-W
		71VNX	100VNX 100VSX	125VNX 125VSX	140VNX 140VSX	100VNA 100VSA	125VNA 125VSA	140VNA 140VSA	200VSA	—	250VSA	—
Twin		40 + 40	50 + 50	60 + 60	71 + 71	50 + 50	60 + 60	71 + 71	100 + 100	100 + 100	125 + 125	140 + 140
Triple					50 + 50 + 50			50 + 50 + 50	71 + 71 + 71	71 + 71 + 71		
Double Twin								50+50+50+50	50+50+50+50	60+60+60+60	71+71+71+71	

# V Multi System

Ideal for the installation in large areas and L-shaped rooms, the V Multi System has an extensive degree of flexibility in the selection of indoor units. Specifically, the selection of indoor units with different capacities in different types can be made.

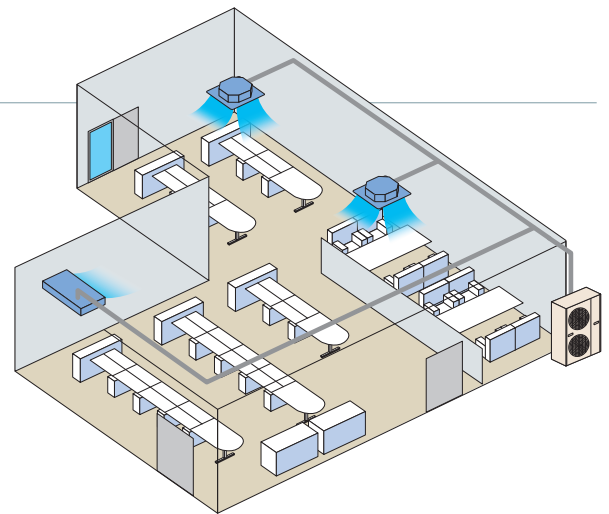

### Combination of indoor units

Outdoor Unit		Hyper Inverter				Micro Inverter						
FDC		71VNX-W	100VNX-W 100VSX-W	125VNX-W 125VSX-W	140VNX-W 140VSX-W	100VNA-W 100VSA-W	125VNA-W 125VSA-W	140VNA-W 140VSA-W	—	200VSA-W	250VSA-W	280VSA-W
		71VNX	100VNX 100VSX	125VNX 125VSX	140VNX 140VSX	100VNA 100VSA	125VNA 125VSA	140VNA 140VSA	200VSA	—	250VSA	—
Twin		40 + 40	50 + 50	60 + 60 50 + 71	71 + 71	50 + 50	60 + 60 50 + 71	71 + 71	100 + 100 71 + 125	100 + 100 71 + 125	125 + 125	140 + 140
Triple					50 + 50 + 50			50 + 50 + 50	71 + 71 + 71	71 + 71 + 71	60+60+125 71+71+100	71+71+140
Double Twin								50+50+50+50	50+50+50+50	60+60+60+60	71+71+71+71	

### Applicable indoor units

Model	Capacity						
	40	50	60	71	100	125	140
Twin / Triple Double Twin Multi System	FDT	●	●	●	●	●	●
	FDTC	●	●	●			
	FDUM	●	●	●	●	●	●
	SRK		●*1	●*1	●*2	●	

Model	Capacity						
	40	50	60	71	100	125	140
Twin / Triple Double Twin Multi System	FDE	●	●	●	●	●	●
	fdf				●	●	●
V Multi System	FDT	●	●	●	●	●	●
	FDE	●	●	●	●	●	●

\* 1 Hyper Inverter model & Micro Inverter -W model only.  
\* 2 Micro Inverter -W model combination only.

## Choice of piping specification

Diagrams below show the application as samples. For further information, refer to TECHNICAL MANUAL.

### Twin type

Models FDC71, FDC100~140, FDC200, FDC250, FDC280  
[Branch pipe set : DIS-WA1G, DIS-WB1G]

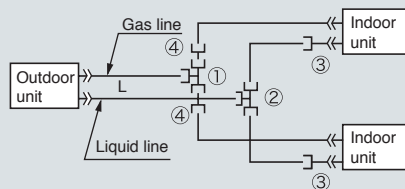

### Triple type

Model FDC140, FDC200  
[Branch pipe set : DIS-TA1G, DIS-TB1G]

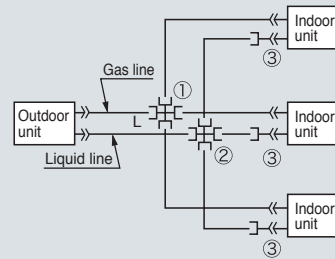

The indoor\_outdoor piping length differences among indoor units are less than 3m.

### Chart of shapes of branch piping parts

Branching pipe set type	Outdoor unit	Indoor unit combinations	Symbol		
			Branching pipe set for a gas pipe	Branching pipe set for a liquid pipe	Different diameter pipe joint
DIS-WA1G (Two-way branching set)	FDC71	40+40	 1 piece	 1 piece	③ Joint A ID9.52 2 pieces Flare Joint (for indoor unit side connection)
	FDC100	50+50			
		40+60			
	FDC125	60+60			
50+71					
FDC140	71+71	 2 pieces			
	50+100				
DIS-WB1G (Two-way branching set)	FDC200	100+100	 1 piece	 1 piece	④ Joint C OD12.7 1 piece ID9.52
		71+125			
	FDC250 FDC280	125+125 140+140			
DIS-TA1G (Three-way branching set)	FDC140	50+50+50	 1 piece	 1 piece	③ Joint A ID9.52 3 pieces Flare Joint (for indoor unit side connection)

Symbol ① to ④ in the drawing shows the symbols of branch piping parts in the chart respectively.

Branch piping should always be arranged to have level or perpendicular position.

### Notes

- When 40-60 models of indoor units are applied to this combination, the reducer supplied with the branch piping set should be used in order to reduce the liquid piping size from ø9.52mm to ø6.35mm at indoor unit side (flare connection). Accordingly be sure to select the liquid piping size ø9.52mm from branch to indoor unit.
- The reducer ④ is for FDC71 and 100 models only.

ID stands for inner diameter and OD, outer diameter.

The branch piping (both gas and liquid lines) should always be arranged to have a level or perpendicular position.

#### 2-Way Branch

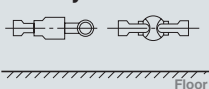

Mount — sections level with the floor.

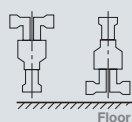

Mount — sections perpendicular to the floor.

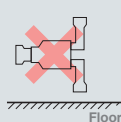



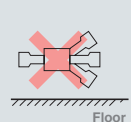
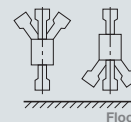
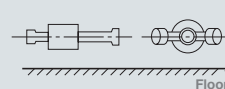













#### 3-Way Branch



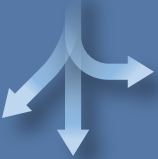













# Indoor units

## BENEFITS SUMMARY

		FDT	FDTc	FDU	FDUM	SRK	FDE	FDF	
									
<b>Energy-Saving</b> 	 <b>Inverter Technology</b> Inverter control technology delivers high efficiency and a smooth operation from high speed to low speed. A smooth sine voltage wave is attained.	●	●	●	●	●	●	●	
	 <b>Energy-Saving Operation *</b> Since the capacity is controlled automatically based on the outdoor temperature, energy can be saved without losing comfort.	●	●	●	●	●	●	●	●
	 <b>Motion Sensor *</b> This sensor detects human activity and shifts the temperature setting according to the amount of activity in the room.	● Option	● Option	● Option	● Option		● Option	● Option	
	 <b>Home Leave Operation</b> This function ensures that when the room is unoccupied for long periods of time, the unit will maintain a moderate indoor temperature, avoiding extremely hot or cool temperatures.	●	●	●	●	●	●	●	
	 <b>Set Temperature Auto Return *</b> This function allows the user to program a preferred set temperature that the unit will return to each time it is operated.	●	●	●	●	●	●	●	
<b>Comfort</b> 	 <b>Automatic Operation</b> This function automatically selects the required heating or cooling function based on the current room conditions.	●	●	●	●	●	●	●	
	 <b>Silent Operation</b> This function allows the user to program periods where the unit will operate with reduced noise levels, perfect for night time and an uninterrupted sleep.	●	●	●	●	●	●	●	
	 <b>Hi Power Operation</b> Use the high power function to quickly reach your optimum temperature level when you first turn on the unit. This function will operate for a maximum of 15 minutes before returning to normal operation.	●	●	●	●	●	●	●	
<b>Air Flow</b> 	 <b>Flap Control System</b> This function allows the user to set the upper and lower limit positions of the flap at each air outlet individually, providing you with complete control over interior air flow.	●	●			●	●		
	 <b>Vertical Auto Swing</b> The vertical louvers on your unit will move up and down continuously during operation. This function allows you to set the up/down swing position of the louver to the preferred operation angle.	●	●			●	●	●	
	 <b>Draft Prevention Setting *</b> Draft Prevention setting provides a comfortable air flow without any draft feeling. Whether cooling or heating a room, the remote control can be used to instantly suppress any warm or cool drafts. This accurately assists how air flow is directed out of the indoor unit.	● Option	● Option						
	 <b>Automatic Fan Speed</b> The unit's on-board microcomputer continuously monitors the room's air temperature and adjusts the air flow automatically.	●	●	●	●	●	●	●	

When using RC-EX3A (Remote control), functions with symbol  are available. However, for RC-E5 (Remote control), functions with \* are not available.

FDT	FDTC	FDU	FDUM	SRK	FDE	PDF	FDT	FDTC	FDU	FDUM	SRK	FDE	PDF
													
P24	P42	P50	P60	P74	P82	P96							

		FDT	FDTC	FDU	FDUM	SRK	FDE	PDF
<b>Timer</b> 	 <b>Sleep Timer</b> This function allows the user to set a pre-determined amount of time between 30 and 240 minutes that your unit will operate for before switching off.	●	●	●	●	●	●	●
	 <b>Peak-Cut Timer *</b> This function lets the user to preset the capacity limit during certain periods of the day, minimising energy consumption during peak billing times, thus reducing operation costs.	●	●	●	●	●	●	●
	 <b>Weekly Timer</b> Set the unit to turn on and off automatically on a weekly basis to suit your usual room usage on each day.	●	●	●	●	●	●	●
<b>Convenience</b> 	 <b>Function Switch *</b> From the seven available functions on the unit, this function allows the user to set two functions to operate automatically.	●	●	●	●	●	●	●
	 <b>Favourite Setting *</b> Operation mode, set temperature, fan speed and air flow direction automatically adjust to the programmed favourite setting.	●	●	●	●	●	●	●
	 <b>Select the Language *</b> Set the language to be displayed on the remote control.	●	●	●	●	●	●	●
	 <b>Air Filter</b> The air filter in the unit traps and removes airborne dust particles and other allergens to provide you clean air.	●	●	Procure locally	● Option	●	●	●
	 <b>Filter Sign</b> This warning alerts when the filter needs to be cleaned.	●	●	●	●	●	●	●
	 <b>Outside Air Intake</b> This function provides clean fresh air into the room through the external air intake, avoiding the constant recycling of internal air.	●	●	●	●			
	 <b>Self Diagnostics</b> The internal microcomputer automatically runs a diagnostic of the system in the event of a malfunction. This enables authorised dealers to isolate and repair any issues.	●	●	●	●	●	●	●
<b>Others</b>	 <b>Built in Drain Pump</b> The built-in drain pump, allows greater flexibility with installation, offering a great solution for applications with limited space.	●	●	● *1	●			
	 <b>Improved Serviceability</b> The fan unit (comprised of impeller and motor) is easily accessible from either the side or bottom of the unit and can be slid out for easy maintenance.			●	●			

\*1 : Except 200 • 250 • 280

# FDT

## Indoor Unit Ceiling Cassette -4way-



FDT 40/50/60/71/100/125/140

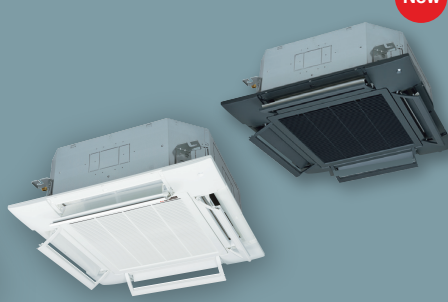

Draft Prevention Panel (Option)



- Energy Saving
- Home Leave
- Hi Power
- Silent Operation
- Flap Control
- Favourite Setting



### Remote control (option)

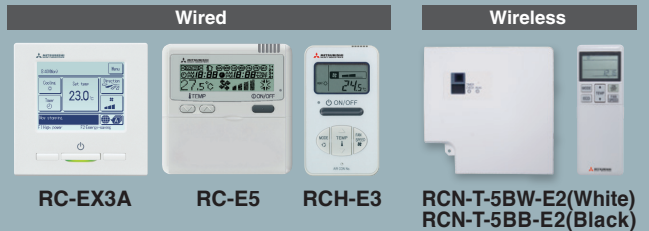

\*Not all functions available with all remote control options.

## Draft Prevention Panel (Option)

This prevents cold/hot draft being blown directly on the user. It is possible to set Draft Prevention Panel for each air outlet.



User can position panels by using the remote controller only (RC-EX3A, Wireless kit) when Draft Prevention Panel is available.

## Motion Sensor (Option)

Motion sensor is equipped in the corner of the panel and detects the presence/absence and activity of humans in a room to improve the comfort and energy saving performance of the unit.

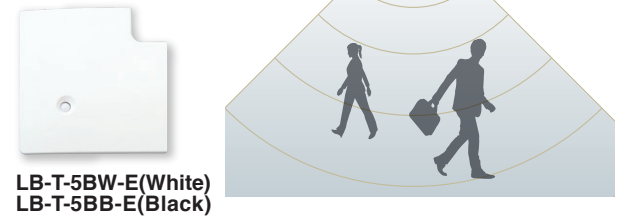

## Individual Flap Control System

According to room conditions, four directions of air flow can be controlled individually by utilizing the flap control system. Individual flap control is available even after installation.

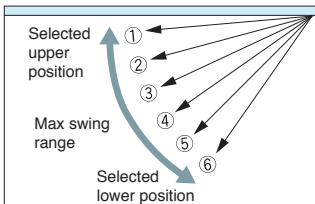
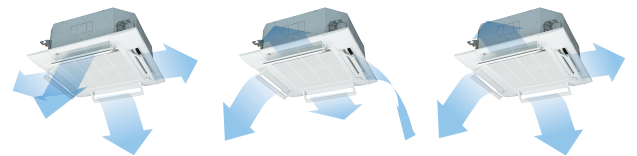

Flap can swing within an upper and lower flap range position within can be selected with a wired remote control.

\* The wireless remote control is not applicable to the Individual flap control system.

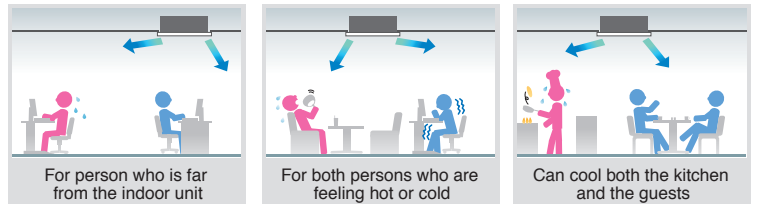



## Reduced Noise

New technology has achieved low noise (in cooling) while keeping capacity and comfort.

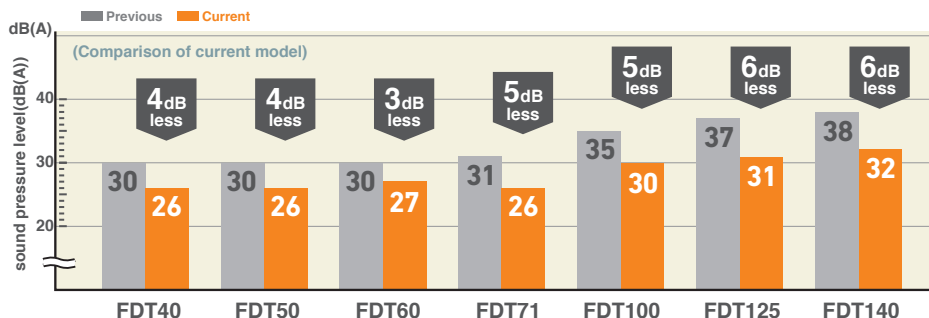

## Panel Select Pattern (Option)

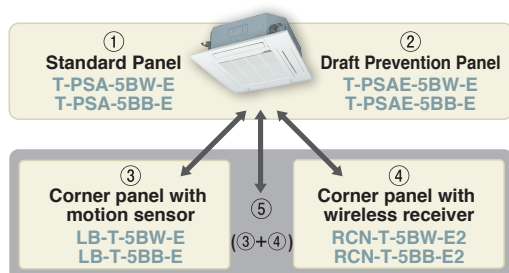

8 patterns of panel are available.

- ① Standard Panel only
- ①+③ Standard Panel with corner panel with motion sensor
- ①+④ Standard Panel with corner panel with wireless receiver
- ①+⑤ Standard Panel with corner panel with motion sensor & corner panel with wireless receiver
- ② Draft Prevention Panel only
- ②+③ Draft Prevention Panel with corner panel with motion sensor
- ②+④ Draft Prevention Panel with corner panel with wireless receiver
- ②+⑤ Draft Prevention Panel with corner panel with motion sensor & corner panel with wireless receiver

Installation position of Wireless kit and Motion sensor kit

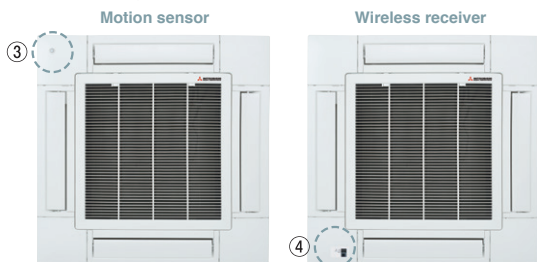

\*Wireless receiver and Motion sensor can be installed to the position as shown

## Suitable for High ceilings

The Powerful blowout carries comfortable air flow to the floor even in high ceiling applications. It is ideal for high ceiling offices, stores, etc., with a wide, uniform air flow throughout the room.

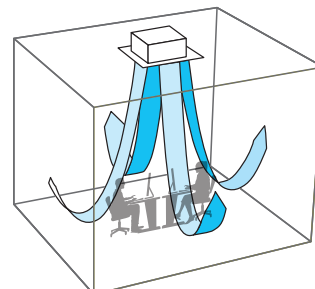

## 850mm Drain Pump

Drain can be discharged upward by 850mm from the ceiling surface close to the indoor unit.

It allows a piping layout with a high degree of freedom depending on the installation location.

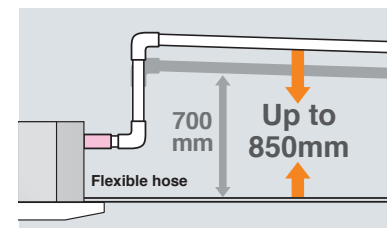

## OUTDOOR UNIT

		Hyper Inverter		
SRC · FDC		40~60ZSX-W1,-W2	71VNX-W	100~140VN(S)X-W
		40~60ZSX-S	71VNX	100~140VN(S)X
model				
Chargeless		15m	30m	
Height x Width x Depth (mm)		640 x 800(+71) x 290	750 x 880(+88) x 340	1,300 x 970 x 370

		Micro Inverter			Standard Inverter		
FDC		100~140VN(S)A-W	-	200·250·280VSA-W	71VNP-W	90~100VNP-W	125VNP-W
		100~140VN(S)A	200VSA	250VSA	71VNP	90VNP1	100VNP
model							
Chargeless		30m			15m		
Height x Width x Depth (mm)		845 x 970 x 370	1,300 x 970 x 370	1,505 x 970 x 370	640 x 800(+71) x 290	750 x 880(+88) x 340	845 x 970 x 370

Easy and quick installation and maintenance

# Serviceability & Workability

**Quick positioning !**

## Indoor unit is easily positioned and installed

**1 Adjustable easier positioning of unit by new slits.** FDT

New shape of slit is suitable to install the unit with more flexibility, compatible with many kinds of suspending bolt pitch on site. Any rectangular or squared pitch of suspending bolts are available with this slit.

Compatible with both square or rectangular bolt pitch

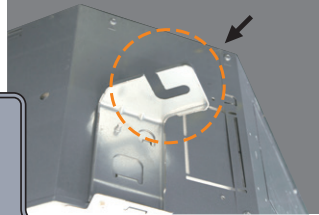
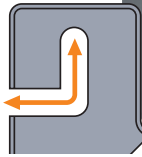

**2 New slit in panel allows easier installation on site.** FDT  
FDTC

Flexible positioning is available, which helps adjusting the direction of panel accordingly to lines or pattern on the ceiling.

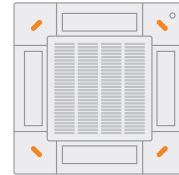
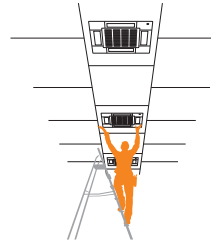

**4 long slits are available.**

## Quick installation and maintenance

**1 Easy access to component part for easy maintenance.** FDT

1. The control box and bell mouth can be removed together.

2. Easy access to impeller and fan motor.

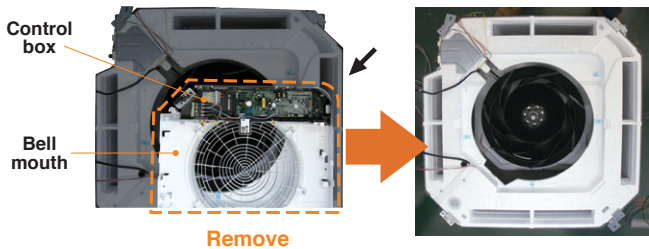

**Remove**

**2 New shape of path of wiring.** FDT

New shape of path gives easy wiring work for installation.

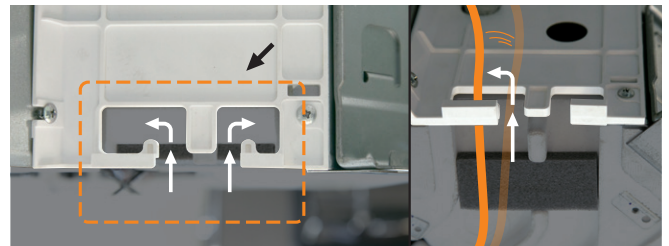

**Easy wiring work**

**3 No need to remove screws to open the controller cover.** FDT

It is possible to loose and slide open the cover without removing the screws. This prevents the cover from falling and causing damage on site.

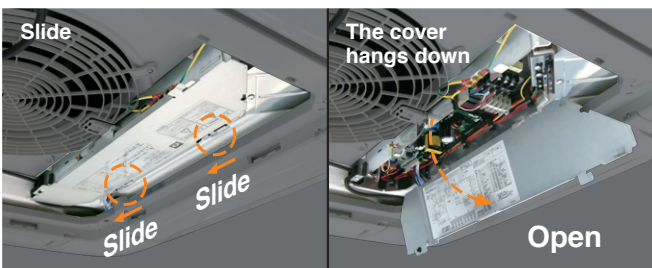

**No need to remove screws**



**4 Safer installation by stopper of washer.** FDT  
FDTC

When unit is installed with hook between washers, this stopper helps to install the unit safely, without adjusting washer.

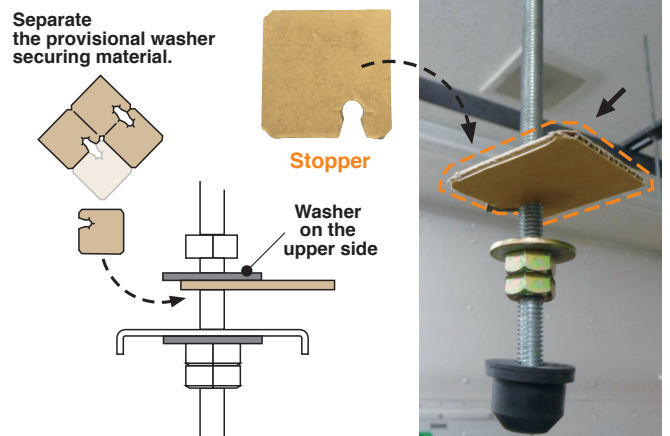



Builder



Maintenance



FDT



FDTC

For smooth and easy working

## Good help for installation and maintenance

### 1 Easy and flexible hook to remove the filter

FDT  
FDTC

Hook of soft material helps to remove the filter without dust spreading.

Press the filter tab to the outside and remove the filter.

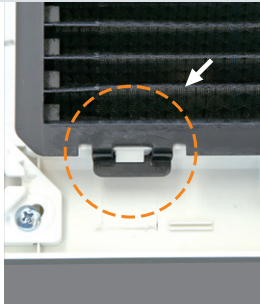

Soft material

### 2 Securely fix the corner lid by strap

FDT

The direction of the strap hook part has been changed from longitudinal to lateral. Furthermore, a barb has been added to the hook pin to prevent the strap from coming off.

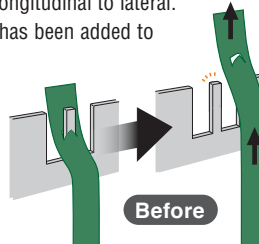

After

Easy to hook but not easy to loose

### 3 Drain-up-lift increases up to 850 mm

FDT  
FDTC

The drain can be lifted up to 850 mm from the ceiling surface.

	Previous	New
FDT	700	850
FDTC	600	850

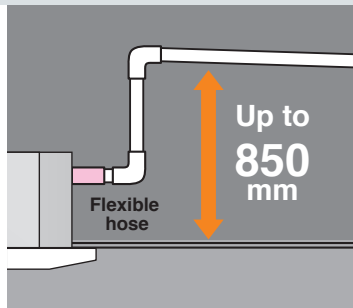

Up to 850 mm

Flexible hose

### 4 New port to check drain water flow

FDT

A water supply port has been provided in the piping lid for easier testing of the drain water flow. (The port is usually sealed with a rubber cap.)

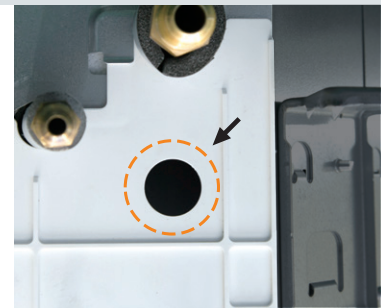

### 5 Re-use of packages during construction work

FDT  
FDTC

Package material (carton) helps to protect the unit from unexpected welding spatter or dust on the new unit.

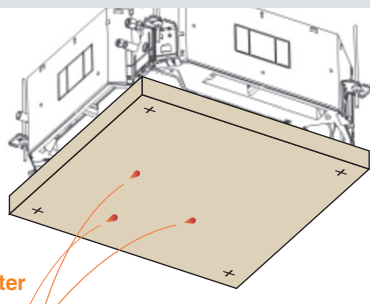

Spatter

### 6 More flexible outlet for ducting

FDT  
FDTC

Both  $\phi 125$  and  $\phi 200$  (oval shaped) are available.

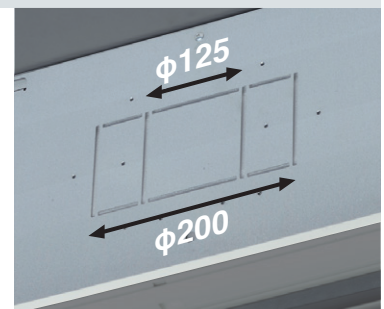
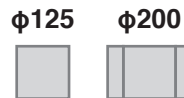

### 7 Easy check of drain pan

FDT  
FDTC

Easy inspection of the condition of the drain pan is possible by removing only the corner lid.



Remove corner lid. Remove drain cap cover and check the condition. It is necessary to clean-up, firstly remove the rubber stopper to drain water out and secondly remove the drain cap.

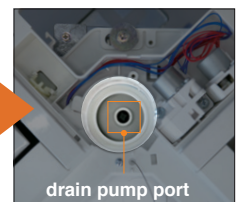
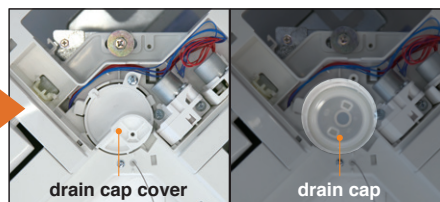
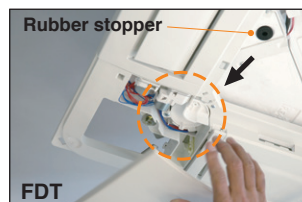

# DIMENSIONS (Unit:mm) - FDT -

## Models FDT40VH, 50VH, 60VH, 71VH

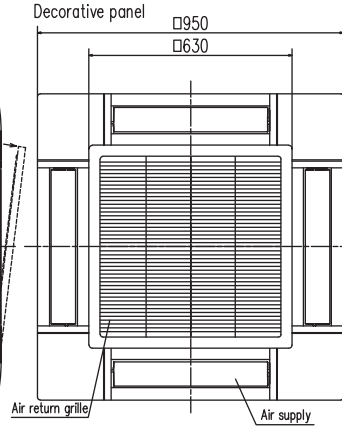
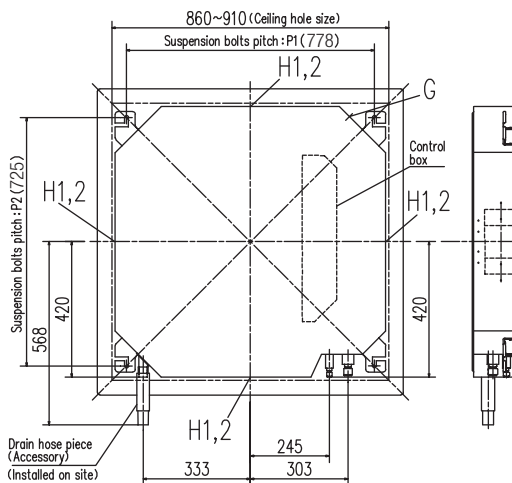

Symbol	Model	Content
	40,50,60	71
A	Gas piping	φ127 (1/2") (Flare) / φ158.8 (5/8") (Flare)
B	Liquid piping	φ6.35 (1/4") (Flare) / φ9.52 (3/8") (Flare)
C	Drain piping	VP25 (O.D.32)
D	Hole for wiring	
F	Suspension bolts	(M10 or M8)
G	Outside air opening for ducting	(Knock out)
H1	Air outlet opening for ducting	φ125 (Knock out)
H2		φ200 (Knock out)

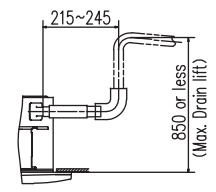
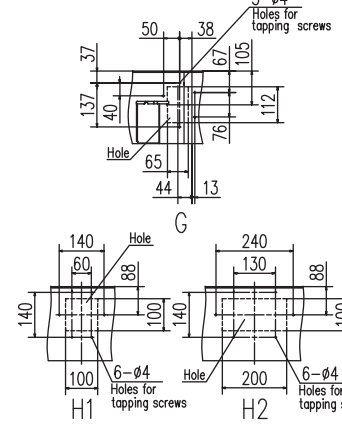
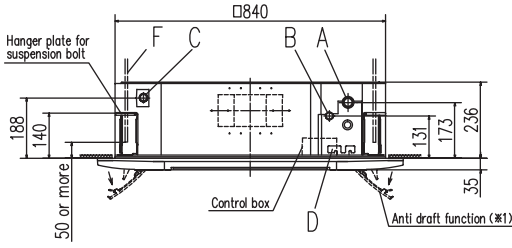
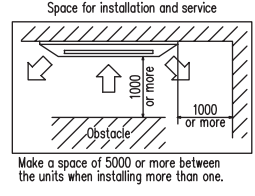

Notes (1) The model name label is attached to the control box lid.  
 (2) Suspension bolt pitch P1,P2 is adjustable by a pattern of the right table.  
 (3) Section 1 (#1) is provided on the panel T-PSAE-5BW-E, T-PSAE-5BB-E only.

Symbol Pattern	P1	P2
1	770	725~770
2	770~800	725

## Models FDT100VH, 125VH, 140VH

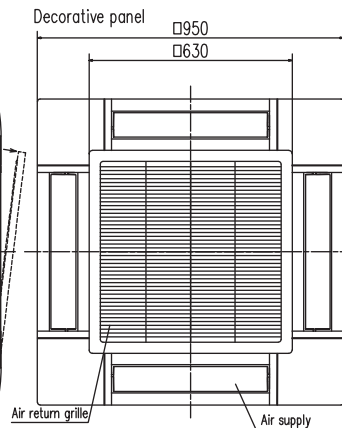
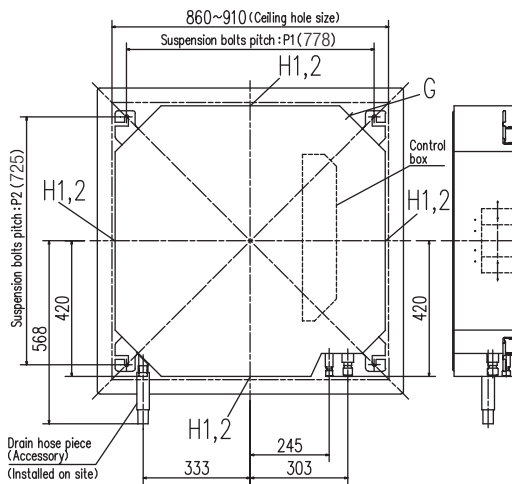

Symbol	Content
A	Gas piping φ15.88 (5/8") (Flare)
B	Liquid piping φ9.52 (3/8") (Flare)
C	Drain piping VP25 (O.D.32)
D	Hole for wiring
F	Suspension bolts (M10 or M8)
G	Outside air opening for ducting (Knock out)
H1	Air outlet opening for ducting φ125 (Knock out)
H2	φ200 (Knock out)

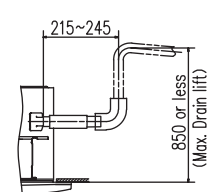
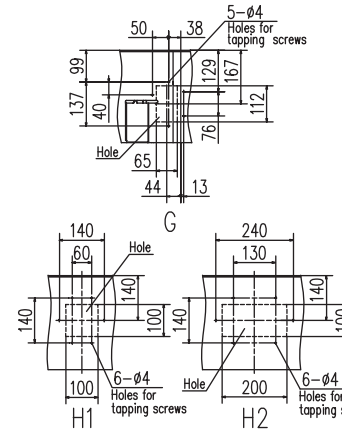
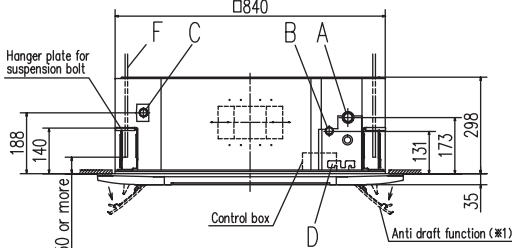
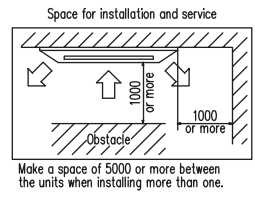

Notes (1) The model name label is attached to the control box lid.  
 (2) Suspension bolt pitch P1,P2 is adjustable by a pattern of the right table.  
 (3) Section 1 (#1) is provided on the panel T-PSAE-5BW-E, T-PSAE-5BB-E only.

Symbol Pattern	P1	P2
1	770	725~770
2	770~800	725

R32		Hyper Inverter				
Set model name		FDT40ZSXW1VH	FDT50ZSXW2VH	FDT60ZSXW1VH	FDT71VNXWVH	
Indoor unit		FDT40VH	FDT50VH	FDT60VH	FDT71VH	
Outdoor unit		SRC40ZSX-W1	SRC50ZSX-W2	SRC60ZSX-W1	FDC71VNX-W	
Power source		1 Phase 220-240V, 50Hz / 220V, 60Hz				
Nominal cooling capacity (Min~Max)		kW 4.0 (1.1 ~ 4.7)	5.0 (1.1 ~ 5.6)	5.6 (1.1 ~ 6.3)	7.1 (3.2 ~ 8.0)	
Nominal heating capacity (Min~Max)		kW 4.5 (0.6 ~ 5.4)	5.4 (0.6 ~ 6.3)	6.7 (0.6 ~ 6.7)	8.0 (3.6 ~ 9.0)	
Power consumption	Cooling/Heating	kW 0.890 / 1.03	1.29 / 1.31	1.33 / 1.56	1.69 / 1.75	
EER/COP	Cooling/Heating	4.49 / 4.37	3.88 / 4.12	4.21 / 4.29	4.20 / 4.58	
Inrush current	A	5	5	5	5	
Max. current		15	15	15	19.1	
Sound power level*1	Indoor	Cooling/Heating	50 / 50	55 / 56	58 / 59	59 / 60
	Outdoor	Cooling/Heating	63 / 62	63 / 62	65 / 65	66 / 66
Sound pressure level*1	Indoor	Cooling (P-Hi/Hi/Me/Lo)	36 / 33 / 30 / 26	41 / 33 / 30 / 26	44 / 34 / 30 / 27	46 / 34 / 31 / 26
		Heating (P-Hi/Hi/Me/Lo)	36 / 33 / 28 / 20	42 / 33 / 28 / 20	44 / 34 / 30 / 23	46 / 34 / 31 / 26
Air flow	Indoor	Cooling (P-Hi/Hi/Me/Lo)	19 / 16 / 13 / 10	22 / 16 / 13 / 10	26 / 17 / 14 / 11	28 / 18 / 15 / 12
		Heating (P-Hi/Hi/Me/Lo)	19 / 16 / 13 / 10	22 / 16 / 13 / 10	26 / 17 / 14 / 11	28 / 18 / 15 / 12
	Outdoor	Cooling/Heating	33 / 33	39 / 33	41.5 / 39	60 / 50
Exterior dimensions	Indoor	HeightxWidthxDepth	Unit: 236 x 840 x 840 Panel: 35 x 950 x 950			
	Outdoor		640 x 800(+71) x 290		750 x 880(+88) x 340	
Net weight	Indoor	kg	24(Unit:19 Standard Panel:5)		26(Unit:21 Standard Panel:5)	
	Outdoor		45		60	
Ref.piping size	Liquid/Gas	ømm	6.35(1/4") / 12.7(1/2")		9.52(3/8") / 15.88(5/8")	
Refrigerant line (one way) length		m	Max.30		Max.50	
Vertical height differences	Outdoor is higher/lower		Max.20 / Max.20		Max.30 / Max.15	
Outdoor operating temperature range	Cooling	°CDB	-15~46*2		-15~50*2	
	Heating	°CWB	-20~20			
Panel	T-PSA-5BW-E, T-PSAE-5BW-E(White) / T-PSA-5BB-E, T-PSAE-5BB-E(Black)					
Air filter, Q'ty	Pocket plastic net x 1(Washable)					
Remote control (option)	wired:RC-EX3A, RC-E5, RCH-E3 wireless:RCN-T-5BW-E2, RCN-T-5BB-E2					

R32		Hyper Inverter			
Set model name		FDT100VNXWVH	FDT125VNXWVH	FDT140VNXWVH	
Indoor unit		FDT100VH	FDT125VH	FDT140VH	
Outdoor unit		FDC100VNX-W	FDC125VNX-W	FDC140VNX-W	
Power source		1 Phase 220-240V, 50Hz / 220V, 60Hz			
Nominal cooling capacity (Min~Max)		kW 10.0 (3.5 ~ 11.2)	12.5 (3.5 ~ 14.0)	14.0 (3.5 ~ 16.0)	
Nominal heating capacity (Min~Max)		kW 11.2 (2.7 ~ 12.5)	14.0 (2.7 ~ 17.0)	16.0 (2.7 ~ 18.0)	
Power consumption	Cooling/Heating	kW 2.28 / 2.48	3.21 / 3.43	3.87 / 4.20	
EER/COP	Cooling/Heating	4.38 / 4.52	3.89 / 4.08	3.62 / 3.81	
Inrush current	A	5	5	5	
Max. current		25	27	27	
Sound power level*1	Indoor	Cooling/Heating	62 / 62	63 / 64	63 / 64
	Outdoor	Cooling/Heating	67 / 67	68 / 70	69 / 71
Sound pressure level*1	Indoor	Cooling (P-Hi/Hi/Me/Lo)	47 / 39 / 36 / 30	48 / 41 / 39 / 31	48 / 42 / 39 / 32
		Heating (P-Hi/Hi/Me/Lo)	47 / 39 / 36 / 29	48 / 41 / 38 / 31	48 / 41 / 38 / 31
Air flow	Indoor	Cooling/Heating	53 / 51	53 / 54	54 / 54
		Cooling (P-Hi/Hi/Me/Lo)	37 / 26 / 23 / 17	38 / 28 / 25 / 18	38 / 29 / 26 / 19
	Outdoor	Cooling/Heating	37 / 26 / 23 / 17	38 / 28 / 25 / 18	38 / 29 / 26 / 19
	Outdoor	Cooling/Heating	100 / 100	100 / 100	100 / 100
Exterior dimensions	Indoor	HeightxWidthxDepth	Unit: 298 x 840 x 840 Panel: 35 x 950 x 950		
	Outdoor		1,300 x 970 x 370		
Net weight	Indoor	kg	30(Unit:25 Standard Panel:5)		
	Outdoor		97		
Ref.piping size	Liquid/Gas	ømm	9.52(3/8") / 15.88(5/8")		
Refrigerant line (one way) length		m	Max.100		
Vertical height differences	Outdoor is higher/lower		Max.50 / Max.15		
Outdoor operating temperature range	Cooling	°CDB	-15~50*2		
	Heating	°CWB	-20~20		
Panel	T-PSA-5BW-E, T-PSAE-5BW-E(White) / T-PSA-5BB-E, T-PSAE-5BB-E(Black)				
Air filter, Q'ty	Pocket plastic net x 1(Washable)				
Remote control (option)	wired:RC-EX3A, RC-E5, RCH-E3 wireless:RCN-T-5BW-E2, RCN-T-5BB-E2				

**NOTES:**

The data are measured under the following conditions(ISO-T1, -H1).  
 Cooling:Indoor temp. of 27°CDB, 19°CWB, and outdoor temp. of 35°CDB. Heating:Indoor temp. of 20°CDB, and outdoor temp. of 7°CDB, 6°CWB.  
 \*1 : Indicates the value in an anechoic chamber. During operation these values are somewhat higher due to ambient conditions.  
 \*2 : If a cooling operation is conducted when the outdoor air temperature is -5°C or lower, the outdoor unit should be installed at a place where it is not influenced by natural wind. If wind blows, the low pressure will drop and compressor frequency will increase, this will cause the capacity to drop and may cause the unit to break down.

## SPECIFICATIONS -FDT-

R32		Hyper Inverter		
Set model name		FDT100VSXWVH	FDT125VSXWVH	FDT140VSXWVH
Indoor unit		FDT100VH	FDT125VH	FDT140VH
Outdoor unit		FDC100VSX-W	FDC125VSX-W	FDC140VSX-W
Power source		3 Phase 380-415V, 50Hz / 380V, 60Hz		
Nominal cooling capacity (Min-Max)	kW	10.0 ( 3.5 ~ 11.2 )	12.5 ( 3.5 ~ 14.0 )	14.0 ( 3.5 ~ 16.0 )
Nominal heating capacity (Min-Max)	kW	11.2 ( 2.7 ~ 16.0 )	14.0 ( 2.7 ~ 18.0 )	16.0 ( 2.7 ~ 20.0 )
Power consumption	Cooling/Heating	2.28 / 2.48	3.21 / 3.43	3.87 / 4.20
EER/COP	Cooling/Heating	4.38 / 4.52	3.89 / 4.08	3.62 / 3.81
Inrush current		5	5	5
Max. current		14	14	14
Sound power level*1	Indoor	Cooling/Heating	62 / 62	63 / 64
	Outdoor	Cooling/Heating	67 / 67	69 / 71
Sound pressure level*1	Indoor	Cooling (P-Hi/Hi/Me/Lo)	47 / 39 / 36 / 30	48 / 41 / 39 / 31
		Heating (P-Hi/Hi/Me/Lo)	47 / 39 / 36 / 29	48 / 41 / 38 / 31
Air flow	Indoor	Cooling (P-Hi/Hi/Me/Lo)	37 / 26 / 23 / 17	38 / 28 / 25 / 18
		Heating (P-Hi/Hi/Me/Lo)	37 / 26 / 23 / 17	38 / 28 / 25 / 18
	Outdoor	Cooling/Heating	100 / 100	100 / 100
Exterior dimensions	Indoor	HeightxWidthxDepth	Unit: 298 x 840 x 840 Panel: 35 x 950 x 950	
	Outdoor		1,300 x 970 x 370	
Net weight	Indoor		30(Unit:25 Standard Panel:5)	
	Outdoor		99	
Ref.piping size	Liquid/Gas	ømm	9.52(3/8") / 15.88(5/8")	
Refrigerant line (one way) length		m	Max.100	
Vertical height differences	Outdoor is higher/lower	m	Max.50 / Max.15	
Outdoor operating temperature range	Cooling	°CDB	-15~50*2	
	Heating	°CWB	-20~20	
Panel			T-PSA-5BW-E, T-PSAE-5BW-E(White) / T-PSA-5BB-E, T-PSAE-5BB-E(Black)	
Air filter, Q'ty			Pocket plastic net x 1(Washable)	
Remote control (option)			wired:RC-EX3A, RC-E5, RCH-E3 wireless:RCN-T-5BW-E2, RCN-T-5BB-E2	

The values are for simultaneous Multi operation.

R32		Hyper Inverter				
Set model name		FDT71VNXWPVH	FDT100VNXWPVH	FDT125VNXWPVH	FDT140VNXWPVH	FDT140VNXWTVH
		Twin				Triple
Indoor unit		FDT40VH x 2	FDT50VH x 2	FDT60VH x 2	FDT71VH x 2	FDT50VH x 3
Outdoor unit		FDC71VNX-W	FDC100VNX-W	FDC125VNX-W	FDC140VNX-W	FDC140VNX-W
Power source		1 Phase 220-240V, 50Hz / 220V, 60Hz				
Nominal cooling capacity (Min-Max)	kW	7.1 ( 3.2 ~ 8.0 )	10.0 ( 3.5 ~ 11.2 )	12.5 ( 3.5 ~ 14.0 )	14.0 ( 3.5 ~ 16.0 )	14.0 ( 3.5 ~ 16.0 )
Nominal heating capacity (Min-Max)	kW	8.0 ( 3.6 ~ 9.0 )	11.2 ( 2.7 ~ 12.5 )	14.0 ( 2.7 ~ 17.0 )	16.0 ( 2.7 ~ 18.0 )	16.0 ( 2.7 ~ 18.0 )
Power consumption	Cooling/Heating	1.61 / 1.83	2.30 / 2.64	2.98 / 3.03	3.44 / 3.64	3.48 / 3.74
EER/COP	Cooling/Heating	4.40 / 4.38	4.35 / 4.25	4.19 / 4.62	4.07 / 4.40	4.02 / 4.28
Inrush current		5	5	5	5	5
Max. current		19.1	25	27	27	27
Sound power level*1	Indoor*3	Cooling/Heating	50 / 50	55 / 56	58 / 59	59 / 60
	Outdoor	Cooling/Heating	66 / 66	67 / 67	68 / 70	69 / 71
Sound pressure level*1	Indoor*3	Cooling (P-Hi/Hi/Me/Lo)	36 / 33 / 30 / 26	41 / 33 / 30 / 26	44 / 34 / 30 / 27	46 / 34 / 31 / 26
		Heating (P-Hi/Hi/Me/Lo)	36 / 33 / 28 / 20	42 / 33 / 28 / 20	44 / 34 / 30 / 23	46 / 34 / 31 / 26
Air flow	Indoor*3	Cooling (P-Hi/Hi/Me/Lo)	19 / 16 / 13 / 10	22 / 16 / 13 / 10	26 / 17 / 14 / 11	28 / 18 / 15 / 12
		Heating (P-Hi/Hi/Me/Lo)	19 / 16 / 13 / 10	22 / 16 / 13 / 10	26 / 17 / 14 / 11	28 / 18 / 15 / 12
	Outdoor	Cooling/Heating	60 / 50	100 / 100	100 / 100	100 / 100
Exterior dimensions	Indoor	HeightxWidthxDepth	Unit: 236 x 840 x 840 Panel: 35 x 950 x 950			
	Outdoor		750 x 880(+88) x 340	1,300 x 970 x 370		
Net weight	Indoor		24(Unit:19 Standard Panel:5)		26(Unit:21 Standard Panel:5)	
	Outdoor		60		97	
Ref.piping size	Liquid/Gas	ømm	9.52(3/8") / 15.88(5/8")			
Refrigerant line (one way) length		m	Max. 50	Max. 100		
Vertical height differences	Outdoor is higher/lower	m	Max.30 / Max.15	Max.50 / Max.15		
Outdoor operating temperature range	Cooling	°CDB	-15~50*2			
	Heating	°CWB	-20~20			
Panel			T-PSA-5BW-E, T-PSAE-5BW-E(White) / T-PSA-5BB-E, T-PSAE-5BB-E(Black)			
Air filter, Q'ty			Pocket plastic net x 1(Washable)			
Remote control (option)			wired:RC-EX3A, RC-E5, RCH-E3 wireless:RCN-T-5BW-E2, RCN-T-5BB-E2			

### NOTES:

The data are measured under the following conditions(R32:ISO-T1,-H1 / R410A:ISO-T1).

Cooling:Indoor temp. of 27°CDB, 19°CWB, and outdoor temp. of 35°CDB. Heating:Indoor temp. of 20°CDB, and outdoor temp. of 7°CDB, 6°CWB.

\*1 : Indicates the value in an anechoic chamber. During operation these values are somewhat higher due to ambient conditions.

\*2 : If a cooling operation is conducted when the outdoor air temperature is -5°C or lower, the outdoor unit should be installed at a place where it is not influenced by natural wind. If wind blows, the low pressure will drop and compressor frequency will increase, this will cause the capacity to drop and may cause the unit to break down.

\*3 : The values are for one indoor unit operation. (Multi system only)

The values are for simultaneous Multi operation.

R32		Hyper Inverter				
Set model name		FDT100VSXWPVH	FDT125VSXWPVH	FDT140VSXWPVH	FDT140VSXWTVH	
		Twin		Triple		
Indoor unit		FDT50VH x 2	FDT60VH x 2	FDT71VH x 2	FDT50VH x 3	
Outdoor unit		FDC100VSX-W	FDC125VSX-W	FDC140VSX-W	FDC140VSX-W	
Power source		3 Phase 380-415V, 50Hz / 380V, 60Hz				
Nominal cooling capacity (Min~Max)	kW	10.0 (3.5 ~ 11.2)	12.5 (3.5 ~ 14.0)	14.0 (3.5 ~ 16.0)	14.0 (3.5 ~ 16.0)	
Nominal heating capacity (Min~Max)	kW	11.2 (2.7 ~ 16.0)	14.0 (2.7 ~ 18.0)	16.0 (2.7 ~ 20.0)	16.0 (2.7 ~ 20.0)	
Power consumption	Cooling/Heating kW	2.30 / 2.64	2.98 / 3.03	3.44 / 3.64	3.48 / 3.74	
EER/COP	Cooling/Heating	4.35 / 4.25	4.19 / 4.62	4.07 / 4.40	4.02 / 4.28	
Inrush current	A	5	5	5	5	
Max. current		14	14	14	14	
Sound power level*1	Indoor <sup>+3</sup>	Cooling/Heating	55 / 56	58 / 59	59 / 60	55 / 56
	Outdoor	Cooling/Heating	67 / 67	68 / 70	69 / 71	69 / 71
Sound pressure level*1	Indoor <sup>+3</sup>	Cooling (P-Hi/Hi/Me/Lo)	41 / 33 / 30 / 26	44 / 34 / 30 / 27	46 / 34 / 31 / 26	41 / 33 / 30 / 26
		Heating (P-Hi/Hi/Me/Lo)	42 / 33 / 28 / 20	44 / 34 / 30 / 23	46 / 34 / 31 / 26	42 / 33 / 28 / 20
Air flow	Outdoor	Cooling/Heating	53 / 51	53 / 54	54 / 54	54 / 54
		Cooling (P-Hi/Hi/Me/Lo) Heating (P-Hi/Hi/Me/Lo)	22 / 16 / 13 / 10 22 / 16 / 13 / 10	26 / 17 / 14 / 11 26 / 17 / 14 / 11	28 / 18 / 15 / 12 28 / 18 / 15 / 12	22 / 16 / 13 / 10 22 / 16 / 13 / 10
Exterior dimensions	Indoor Outdoor	HeightxWidthxDepth	mm			
		Unit: 236 x 840 x 840 Panel: 35 x 950 x 950				
		1,300 x 970 x 370				
Net weight	Indoor	kg	24(Unit:19 Standard Panel:5)	26(Unit:21 Standard Panel:5)	24(Unit:19 Standard Panel:5)	
	Outdoor		99			
Ref.piping size	Liquid/Gas	ømm	9.52(3/8") / 15.88(5/8")			
Refrigerant line (one way) length		m	Max.100			
Vertical height differences	Outdoor is higher/lower	m	Max.50 / Max.15			
Outdoor operating temperature range	Cooling	°CDB	-15~50*2			
	Heating	°CWB	-20~20			
Panel	T-PSA-5BW-E, T-PSAE-5BW-E(White) / T-PSA-5BB-E, T-PSAE-5BB-E(Black)					
Air filter, Q'ty	Pocket plastic net x 1(Washable)					
Remote control (option)	wired:RC-EX3A, RC-E5, RCH-E3 wireless:RCN-T-5BW-E2, RCN-T-5BB-E2					

R410A		Hyper Inverter				
Set model name		FDT40ZSXVH	FDT50ZSXVH	FDT60ZSXVH	FDT71VNXVH	
Indoor unit		FDT40VH	FDT50VH	FDT60VH	FDT71VH	
Outdoor unit		SRC40ZSX-S	SRC50ZSX-S	SRC60ZSX-S	FDC71VNX	
Power source		1 Phase 220-240V, 50Hz / 220V, 60Hz				
Nominal cooling capacity (Min~Max)	kW	4.0 (1.1 ~ 4.7)	5.0 (1.1 ~ 5.6)	5.6 (1.1 ~ 6.3)	7.1 (3.2 ~ 8.0)	
Nominal heating capacity (Min~Max)	kW	4.5 (0.6 ~ 5.4)	5.4 (0.6 ~ 6.3)	6.7 (0.6 ~ 7.1)	8.0 (3.6 ~ 9.0)	
Power consumption	Cooling/Heating kW	0.93 / 1.03	1.29 / 1.31	1.52 / 1.56	1.96 / 1.91	
EER/COP	Cooling/Heating	4.30 / 4.37	3.88 / 4.12	3.68 / 4.29	3.62/4.19	
Inrush current	A	5	5	5	5	
Max. current		12	15	15	17	
Sound power level*1	Indoor	Cooling/Heating	50 / 50	55 / 56	58 / 59	59 / 60
	Outdoor	Cooling/Heating	63 / 63	63 / 63	65 / 64	66 / 66
Sound pressure level*1	Indoor	Cooling (P-Hi/Hi/Me/Lo)	36 / 33 / 30 / 26	41 / 33 / 30 / 26	44 / 34 / 30 / 27	46 / 34 / 31 / 26
		Heating (P-Hi/Hi/Me/Lo)	36 / 33 / 28 / 20	42 / 33 / 28 / 20	44 / 34 / 30 / 23	46 / 34 / 31 / 26
Air flow	Outdoor	Cooling/Heating	50 / 49	50 / 49	52 / 52	51 / 48
		Cooling (P-Hi/Hi/Me/Lo) Heating (P-Hi/Hi/Me/Lo)	19 / 16 / 13 / 10 19 / 16 / 13 / 10	22 / 16 / 13 / 10 22 / 16 / 13 / 10	26 / 17 / 14 / 11 26 / 17 / 14 / 11	28 / 18 / 15 / 12 28 / 18 / 15 / 12
Exterior dimensions	Indoor Outdoor	HeightxWidthxDepth	mm			
		Unit: 236 x 840 x 840 Panel: 35 x 950 x 950				
		640 x 800(+71) x 290				
		750 x 880(+88) x 340				
Net weight	Indoor	kg	24(Unit:19 Standard Panel:5)	26(Unit:21 Standard Panel:5)		
	Outdoor		45	60		
Ref.piping size	Liquid/Gas	ømm	6.35(1/4") / 12.7(1/2")		9.52(3/8") / 15.88(5/8")	
Refrigerant line (one way) length		m	Max.30		Max. 50	
Vertical height differences	Outdoor is higher/lower	m	Max.20 / Max.20		Max.30 / Max.15	
Outdoor operating temperature range	Cooling	°CDB	-15~46*2		-15~43*2	
	Heating	°CWB	-20~20			
Panel	T-PSA-5BW-E, T-PSAE-5BW-E(White) / T-PSA-5BB-E, T-PSAE-5BB-E(Black)					
Air filter, Q'ty	Pocket plastic net x 1(Washable)					
Remote control (option)	wired:RC-EX3A, RC-E5, RCH-E3 wireless:RCN-T-5BW-E2, RCN-T-5BB-E2					

## SPECIFICATIONS -FDT-

R410A		Hyper Inverter		
Set model name		FDT100VNXVH	FDT125VNXVH	FDT140VNXVH
Indoor unit		FDT100VH	FDT125VH	FDT140VH
Outdoor unit		FDC100VNX	FDC125VNX	FDC140VNX
Power source		1 Phase 220-240V, 50Hz / 220V, 60Hz		
Nominal cooling capacity (Min-Max)	kW	10.0 ( 4.0 ~ 11.2 )	12.5 ( 5.0 ~ 14.0 )	14.0 ( 5.0 ~ 16.0 )
Nominal heating capacity (Min-Max)	kW	11.2 ( 4.0 ~ 12.5 )	14.0 ( 4.0 ~ 17.0 )	16.0 ( 4.0 ~ 18.0 )
Power consumption	Cooling/Heating	2.50 / 2.58	3.42 / 3.43	4.58 / 4.20
EER/COP	Cooling/Heating	4.00 / 4.34	3.65 / 4.08	3.06 / 3.81
Inrush current		5	5	5
Max. current		24	26	26
Sound power level*1	Indoor	Cooling/Heating	62 / 62	63 / 64
	Outdoor	Cooling/Heating	70 / 70	72 / 72
Sound pressure level*1	Indoor	Cooling (P-Hi/Hi/Me/Lo)	47 / 39 / 36 / 30	48 / 41 / 39 / 31
		Heating (P-Hi/Hi/Me/Lo)	47 / 39 / 36 / 29	48 / 41 / 38 / 31
	Outdoor	Cooling/Heating	48 / 50	48 / 50
				49 / 52
Air flow	Indoor	Cooling (P-Hi/Hi/Me/Lo)	37 / 26 / 23 / 17	38 / 28 / 25 / 18
		Heating (P-Hi/Hi/Me/Lo)	37 / 26 / 23 / 17	38 / 28 / 25 / 18
	Outdoor	Cooling/Heating	100 / 100	100 / 100
Exterior dimensions	Indoor	HeightxWidthxDepth	Unit: 298 x 840 x 840 Panel: 35 x 950 x 950	
	Outdoor		1,300 x 970 x 370	
Net weight	Indoor		30(Unit:25 Standard Panel:5)	
	Outdoor		105	
Ref.piping size	Liquid/Gas	ømm	9.52(3/8") / 15.88(5/8")	
Refrigerant line (one way) length		m	Max.100	
Vertical height differences	Outdoor is higher/lower	m	Max.30 / Max.15	
Outdoor operating temperature range	Cooling	°CDB	-15~43*2	
	Heating	°CWB	-20~20	
Panel			T-PSA-5BW-E, T-PSAE-5BW-E(White) / T-PSA-5BB-E, T-PSAE-5BB-E(Black)	
Air filter, Q'ty			Pocket plastic net x 1(Washable)	
Remote control (option)			wired:RC-EX3A, RC-E5, RCH-E3 wireless:RCN-T-5BW-E2, RCN-T-5BB-E2	

R410A		Hyper Inverter		
Set model name		FDT100VSXVH	FDT125VSXVH	FDT140VSXVH
Indoor unit		FDT100VH	FDT125VH	FDT140VH
Outdoor unit		FDC100VSX	FDC125VSX	FDC140VSX
Power source		3 Phase 380-415V, 50Hz / 380V, 60Hz		
Nominal cooling capacity (Min-Max)	kW	10.0 ( 4.0 ~ 11.2 )	12.5 ( 5.0 ~ 14.0 )	14.0 ( 5.0 ~ 16.0 )
Nominal heating capacity (Min-Max)	kW	11.2 ( 4.0 ~ 16.0 )	14.0 ( 4.0 ~ 18.0 )	16.0 ( 4.0 ~ 20.0 )
Power consumption	Cooling/Heating	2.50 / 2.58	3.42 / 3.43	4.58 / 4.20
EER/COP	Cooling/Heating	4.00 / 4.34	3.65 / 4.08	3.06 / 3.81
Inrush current		5	5	5
Max. current		15	15	15
Sound power level*1	Indoor	Cooling/Heating	62 / 62	63 / 64
	Outdoor	Cooling/Heating	70 / 70	72 / 72
Sound pressure level*1	Indoor	Cooling (P-Hi/Hi/Me/Lo)	47 / 39 / 36 / 30	48 / 41 / 39 / 31
		Heating (P-Hi/Hi/Me/Lo)	47 / 39 / 36 / 29	48 / 41 / 38 / 31
	Outdoor	Cooling/Heating	48 / 50	48 / 50
				49 / 52
Air flow	Indoor	Cooling (P-Hi/Hi/Me/Lo)	37 / 26 / 23 / 17	38 / 28 / 25 / 18
		Heating (P-Hi/Hi/Me/Lo)	37 / 26 / 23 / 17	38 / 28 / 25 / 18
	Outdoor	Cooling/Heating	100 / 100	100 / 100
Exterior dimensions	Indoor	HeightxWidthxDepth	Unit: 298 x 840 x 840 Panel: 35 x 950 x 950	
	Outdoor		1,300 x 970 x 370	
Net weight	Indoor		30(Unit:25 Standard Panel:5)	
	Outdoor		105	
Ref.piping size	Liquid/Gas	ømm	9.52(3/8") / 15.88(5/8")	
Refrigerant line (one way) length		m	Max.100	
Vertical height differences	Outdoor is higher/lower	m	Max.30 / Max.15	
Outdoor operating temperature range	Cooling	°CDB	-15~43*2	
	Heating	°CWB	-20~20	
Panel			T-PSA-5BW-E, T-PSAE-5BW-E(White) / T-PSA-5BB-E, T-PSAE-5BB-E(Black)	
Air filter, Q'ty			Pocket plastic net x 1(Washable)	
Remote control (option)			wired:RC-EX3A, RC-E5, RCH-E3 wireless:RCN-T-5BW-E2, RCN-T-5BB-E2	

### NOTES:

The data are measured under the following conditions(ISO-T1).

Cooling:Indoor temp. of 27°CDB, 19°CWB, and outdoor temp. of 35°CDB. Heating:Indoor temp. of 20°CDB, and outdoor temp. of 7°CDB, 6°CWB.

\*1 : Indicates the value in an anechoic chamber. During operation these values are somewhat higher due to ambient conditions.

\*2 : If a cooling operation is conducted when the outdoor air temperature is -5°C or lower, the outdoor unit should be installed at a place where it is not influenced by natural wind. If wind blows, the low pressure will drop and compressor frequency will increase, this will cause the capacity to drop and may cause the unit to break down.

\*3 : The values are for one indoor unit operation. (Multi system only)



The values are for simultaneous Multi operation.

R410A		Hyper Inverter				
Set model name		FDT71VNXPVH	FDT100VNXPVH	FDT125VNXPVH	FDT140VNXPVH	FDT140VNXTVH
		Twin			Triple	
Indoor unit		FDT40VH x 2	FDT50VH x 2	FDT60VH x 2	FDT71VH x 2	FDT50VH x 3
Outdoor unit		FDC71VNX	FDC100VNX	FDC125VNX	FDC140VNX	FDC140VNX
Power source		1 Phase 220-240V, 50Hz / 220V, 60Hz				
Nominal cooling capacity (Min~Max)	kW	7.1 ( 3.2 ~ 8.0 )	10.0 ( 4.0 ~ 11.2 )	12.5 ( 5.0 ~ 14.0 )	14.0 ( 5.0 ~ 16.0 )	14.0 ( 5.0 ~ 16.0 )
Nominal heating capacity (Min~Max)	kW	8.0 ( 3.6 ~ 9.0 )	11.2 ( 4.0 ~ 12.5 )	14.0 ( 4.0 ~ 17.0 )	16.0 ( 4.0 ~ 18.0 )	16.0 ( 4.0 ~ 18.0 )
Power consumption	Cooling/Heating	1.85 / 1.99	2.56 / 2.67	3.26 / 3.22	3.88 / 3.74	3.93 / 4.00
EER/COP	Cooling/Heating	3.84 / 4.02	3.91 / 4.19	3.83 / 4.35	3.61 / 4.28	3.56 / 4.00
Inrush current	A	5	5	5	5	5
Max. current		17	24	26	26	26
Sound power level*1	Indoor <sup>3</sup>	Cooling/Heating	50 / 50	55 / 56	58 / 59	59 / 60
	Outdoor	Cooling/Heating	66 / 66	70 / 70	70 / 70	72 / 72
Sound pressure level*1	Indoor <sup>3</sup>	Cooling (P-Hi/Hi/Me/Lo)	36 / 33 / 30 / 26	41 / 33 / 30 / 26	44 / 34 / 30 / 27	46 / 34 / 31 / 26
	Outdoor	Heating (P-Hi/Hi/Me/Lo)	36 / 33 / 28 / 20	42 / 33 / 28 / 20	44 / 34 / 30 / 23	46 / 34 / 31 / 26
Air flow	Indoor <sup>3</sup>	Cooling/Heating	51 / 48	48 / 50	48 / 50	49 / 52
	Outdoor	Cooling/Heating	19 / 16 / 13 / 10	22 / 16 / 13 / 10	26 / 17 / 14 / 11	28 / 18 / 15 / 12
Exterior dimensions	Indoor	HeightxWidthxDepth	Unit: 236 x 840 x 840 Panel: 35 x 950 x 950			
	Outdoor		1,300 x 970 x 370			
Net weight	Indoor	kg	24(Unit:19 Standard Panel:5)		26(Unit:21 Standard Panel:5)	24(Unit:19 Standard Panel:5)
	Outdoor		60			
Ref.piping size	Liquid/Gas	ømm	9.52(3/8") / 15.88(5/8")			
Refrigerant line (one way) length		m	Max. 50	Max. 100		
Vertical height differences	Outdoor is higher/lower	m	Max.30 / Max.15			
Outdoor operating temperature range	Cooling	°CDB	-15~43*2			
	Heating	°CWB	-20~20			
Panel	T-PSA-5BW-E, T-PSAE-5BW-E(White) / T-PSA-5BB-E, T-PSAE-5BB-E(Black)					
Air filter, Q'ty	Pocket plastic net x 1(Washable)					
Remote control (option)	wired:RC-EX3A, RC-E5, RCH-E3 wireless:RCN-T-5BW-E2, RCN-T-5BB-E2					

The values are for simultaneous Multi operation.

R410A		Hyper Inverter			
Set model name		FDT100VXSXPVH	FDT125VXSXPVH	FDT140VXSXPVH	FDT140VXSXTVH
		Twin			Triple
Indoor unit		FDT50VH x 2	FDT60VH x 2	FDT71VH x 2	FDT50VH x 3
Outdoor unit		FDC100VVSX	FDC125VVSX	FDC140VVSX	FDC140VVSX
Power source		3 Phase 380-415V, 50Hz / 380V, 60Hz			
Nominal cooling capacity (Min~Max)	kW	10.0 ( 4.0 ~ 11.2 )	12.5 ( 5.0 ~ 14.0 )	14.0 ( 5.0 ~ 16.0 )	14.0 ( 5.0 ~ 16.0 )
Nominal heating capacity (Min~Max)	kW	11.2 ( 4.0 ~ 16.0 )	14.0 ( 4.0 ~ 18.0 )	16.0 ( 4.0 ~ 20.0 )	16.0 ( 4.0 ~ 20.0 )
Power consumption	Cooling/Heating	2.56 / 2.67	3.26 / 3.22	3.88 / 3.74	3.93 / 4.00
EER/COP	Cooling/Heating	3.91 / 4.19	3.83 / 4.35	3.61 / 4.28	3.56 / 4.00
Inrush current	A	5	5	5	5
Max. current		15	15	15	15
Sound power level*1	Indoor <sup>3</sup>	Cooling/Heating	55 / 56	58 / 59	59 / 60
	Outdoor	Cooling/Heating	70 / 70	70 / 70	72 / 72
Sound pressure level*1	Indoor <sup>3</sup>	Cooling (P-Hi/Hi/Me/Lo)	41 / 33 / 30 / 26	44 / 34 / 30 / 27	46 / 34 / 31 / 26
	Outdoor	Heating (P-Hi/Hi/Me/Lo)	42 / 33 / 28 / 20	44 / 34 / 30 / 23	46 / 34 / 31 / 26
Air flow	Indoor <sup>3</sup>	Cooling/Heating	48 / 50	48 / 50	49 / 52
	Outdoor	Cooling/Heating	22 / 16 / 13 / 10	26 / 17 / 14 / 11	28 / 18 / 15 / 12
Exterior dimensions	Indoor	HeightxWidthxDepth	Unit: 236 x 840 x 840 Panel: 35 x 950 x 950		
	Outdoor		1,300 x 970 x 370		
Net weight	Indoor	kg	24(Unit:19 Standard Panel:5)		26(Unit:21 Standard Panel:5)
	Outdoor		105		
Ref.piping size	Liquid/Gas	ømm	9.52(3/8") / 15.88(5/8")		
Refrigerant line (one way) length		m	Max.100		
Vertical height differences	Outdoor is higher/lower	m	Max.30 / Max.15		
Outdoor operating temperature range	Cooling	°CDB	-15~43*2		
	Heating	°CWB	-20~20		
Panel	T-PSA-5BW-E, T-PSAE-5BW-E(White) / T-PSA-5BB-E, T-PSAE-5BB-E(Black)				
Air filter, Q'ty	Pocket plastic net x 1(Washable)				
Remote control (option)	wired:RC-EX3A, RC-E5, RCH-E3 wireless:RCN-T-5BW-E2, RCN-T-5BB-E2				

## SPECIFICATIONS -FDT-

R32		Micro Inverter		
Set model name		FDT100VNAVH	FDT125VNAVH	FDT140VNAVH
Indoor unit		FDT100VH	FDT125VH	FDT140VH
Outdoor unit		FDC100VNA-W	FDC125VNA-W	FDC140VNA-W
Power source		1 Phase 220-240V, 50Hz / 220V, 60Hz		
Nominal cooling capacity (Min-Max)		kW 10.0 (4.0 ~ 11.2)	12.5 (5.0 ~ 14.0)	13.6 (5.0 ~ 14.5)
Nominal heating capacity (Min-Max)		kW 11.2 (4.0 ~ 12.5)	14.0 (4.0 ~ 16.0)	15.5 (4.0 ~ 16.5)
Power consumption		Cooling/Heating kW 2.73 / 2.54	4.05 / 3.59	4.79 / 4.18
EER/COP		Cooling/Heating 3.66 / 4.41	3.09 / 3.90	2.84 / 3.71
Inrush current		A 5	5	5
Max. current		A 24	24	24
Sound power level*1	Indoor	Cooling/Heating 62 / 62	63 / 64	63 / 64
	Outdoor	Cooling/Heating 69 / 70	71 / 71	72 / 73
Sound pressure level*1	Indoor	Cooling (P-Hi/Hi/Me/Lo) 47 / 39 / 36 / 30	48 / 41 / 39 / 31	48 / 42 / 39 / 32
	Outdoor	Heating (P-Hi/Hi/Me/Lo) 47 / 39 / 36 / 29	48 / 41 / 38 / 31	48 / 41 / 38 / 31
Air flow	Indoor	Cooling (P-Hi/Hi/Me/Lo) m <sup>3</sup> /min 37 / 26 / 23 / 17	38 / 28 / 25 / 18	38 / 29 / 26 / 19
		Heating (P-Hi/Hi/Me/Lo) 37 / 26 / 23 / 17	38 / 28 / 25 / 18	38 / 29 / 26 / 19
	Outdoor	Cooling/Heating 75 / 73	75 / 73	75 / 73
Exterior dimensions	Indoor	Unit: 298 x 840 x 840 Panel: 35 x 950 x 950		
	Outdoor	845 x 970 x 370		
Net weight	Indoor	30(Unit:25 Standard Panel:5)		
	Outdoor	77		
Ref.piping size	Liquid/Gas	ømm 9.52(3/8") / 15.88(5/8")		
Refrigerant line (one way) length		m Max.50		
Vertical height differences		Outdoor is higher/lower	m Max.50 / Max.15	
Outdoor operating temperature range	Cooling	°CDB -15~50*2		
	Heating	°CWB -20~20		
Panel		T-PSA-5BW-E, T-PSAE-5BW-E(White) / T-PSA-5BB-E, T-PSAE-5BB-E(Black)		
Air filter, Q'ty		Pocket plastic net x 1(Washable)		
Remote control (option)		wired:RC-EX3A, RC-E5, RCH-E3 wireless:RCN-T-5BW-E2, RCN-T-5BB-E2		

R32		Micro Inverter		
Set model name		FDT100VSAVH	FDT125VSAVH	FDT140VSAVH
Indoor unit		FDT100VH	FDT125VH	FDT140VH
Outdoor unit		FDC100VSA-W	FDC125VSA-W	FDC140VSA-W
Power source		3 Phase 380-415V, 50Hz / 380V, 60Hz		
Nominal cooling capacity (Min-Max)		kW 10.0 (4.0 ~ 11.2)	12.5 (5.0 ~ 14.0)	13.6 (5.0 ~ 14.5)
Nominal heating capacity (Min-Max)		kW 11.2 (4.0 ~ 12.5)	14.0 (4.0 ~ 16.0)	15.5 (4.0 ~ 16.5)
Power consumption		Cooling/Heating kW 2.73 / 2.54	4.05 / 3.59	4.79 / 4.18
EER/COP		Cooling/Heating 3.66 / 4.41	3.09 / 3.90	2.84 / 3.71
Inrush current		A 5	5	5
Max. current		A 15	15	15
Sound power level*1	Indoor	Cooling/Heating 62 / 62	63 / 64	63 / 64
	Outdoor	Cooling/Heating 69 / 70	71 / 71	72 / 73
Sound pressure level*1	Indoor	Cooling (P-Hi/Hi/Me/Lo) 47 / 39 / 36 / 30	48 / 41 / 39 / 31	48 / 42 / 39 / 32
	Outdoor	Heating (P-Hi/Hi/Me/Lo) 47 / 39 / 36 / 29	48 / 41 / 38 / 31	48 / 41 / 38 / 31
Air flow	Indoor	Cooling (P-Hi/Hi/Me/Lo) m <sup>3</sup> /min 37 / 26 / 23 / 17	38 / 28 / 25 / 18	38 / 29 / 26 / 19
		Heating (P-Hi/Hi/Me/Lo) 37 / 26 / 23 / 17	38 / 28 / 25 / 18	38 / 29 / 26 / 19
	Outdoor	Cooling/Heating 75 / 73	75 / 73	75 / 73
Exterior dimensions	Indoor	Unit: 298 x 840 x 840 Panel: 35 x 950 x 950		
	Outdoor	845 x 970 x 370		
Net weight	Indoor	30(Unit:25 Standard Panel:5)		
	Outdoor	78		
Ref.piping size	Liquid/Gas	ømm 9.52(3/8") / 15.88(5/8")		
Refrigerant line (one way) length		m Max.50		
Vertical height differences		Outdoor is higher/lower	m Max.50 / Max.15	
Outdoor operating temperature range	Cooling	°CDB -15~50*2		
	Heating	°CWB -20~20		
Panel		T-PSA-5BW-E, T-PSAE-5BW-E(White) / T-PSA-5BB-E, T-PSAE-5BB-E(Black)		
Air filter, Q'ty		Pocket plastic net x 1(Washable)		
Remote control (option)		wired:RC-EX3A, RC-E5, RCH-E3 wireless:RCN-T-5BW-E2, RCN-T-5BB-E2		

### NOTES:

The data are measured under the following conditions(ISO-T1, -H1).

Cooling:Indoor temp. of 27°CDB, 19°CWB, and outdoor temp. of 35°CDB. Heating:Indoor temp. of 20°CDB, and outdoor temp. of 7°CDB, 6°CWB.

\*1 : Indicates the value in an anechoic chamber. During operation these values are somewhat higher due to ambient conditions.

\*2 : If a cooling operation is conducted when the outdoor air temperature is -5°C or lower, the outdoor unit should be installed at a place where it is not influenced by natural wind. If wind blows, the low pressure will drop and compressor frequency will increase, this will cause the capacity to drop and may cause the unit to break down.

\*3 : The values are for one indoor unit operation. (Multi system only)

The values are for simultaneous Multi operation.

R32		Micro Inverter				
Set model name		FDT100VNAVPVH	FDT125VNAVPVH	FDT140VNAVPVH	FDT140VNAVTVH	
		Twin		Triple		
Indoor unit		FDT50VH x 2	FDT60VH x 2	FDT71VH x 2	FDT50VH x 3	
Outdoor unit		FDC100VNA-W	FDC125VNA-W	FDC140VNA-W	FDC140VNA-W	
Power source		1 Phase 220-240V, 50Hz / 220V, 60Hz				
Nominal cooling capacity (Min~Max)	kW	10.0 (4.0 ~ 11.2)	12.5 (5.0 ~ 14.0)	13.6 (5.0 ~ 14.5)	13.6 (5.0 ~ 14.5)	
Nominal heating capacity (Min~Max)	kW	11.2 (4.0 ~ 12.5)	14.0 (4.0 ~ 16.0)	15.5 (4.0 ~ 16.5)	15.5 (4.0 ~ 16.5)	
Power consumption	Cooling/Heating	2.82 / 2.73	3.79 / 3.31	4.22 / 3.57	4.22 / 3.57	
EER/COP	Cooling/Heating	3.55 / 4.11	3.30 / 4.23	3.22 / 4.34	3.22 / 3.88	
Inrush current	A	5	5	5	5	
Max. current		24	24	24	24	
Sound power level*1	Indoor <sup>3</sup>	Cooling/Heating	55 / 56	58 / 59	59 / 60	55 / 56
	Outdoor	Cooling/Heating	69 / 70	71 / 71	72 / 73	72 / 73
Sound pressure level*1	Indoor <sup>3</sup>	Cooling (P-Hi/Hi/Me/Lo)	41 / 33 / 30 / 26	44 / 34 / 30 / 27	46 / 34 / 31 / 26	41 / 33 / 30 / 26
		Heating (P-Hi/Hi/Me/Lo)	42 / 33 / 28 / 20	44 / 34 / 30 / 23	46 / 34 / 31 / 26	42 / 33 / 28 / 20
Air flow	Outdoor	Cooling/Heating	54 / 55	54 / 56	56 / 58	56 / 58
		Cooling (P-Hi/Hi/Me/Lo)	22 / 16 / 13 / 10	26 / 17 / 14 / 11	28 / 18 / 15 / 12	22 / 16 / 13 / 10
Exterior dimensions	Indoor	HeightxWidthxDepth	mm	Unit: 236 x 840 x 840 Panel: 35 x 950 x 950		
				845 x 970 x 370		
Net weight	Indoor	kg	24(Unit:19 Standard Panel:5)		24(Unit:19 Standard Panel:5)	
			26(Unit:21 Standard Panel:5)		24(Unit:19 Standard Panel:5)	
Ref.piping size	Liquid/Gas	ømm	9.52(3/8") / 15.88(5/8")			
Refrigerant line (one way) length		m	Max.50			
Vertical height differences	Outdoor is higher/lower	m	Max.50 / Max.15			
Outdoor operating temperature range	Cooling	°CDB	-15~50*2			
	Heating	°CWB	-20~20			
Panel			T-PSA-5BW-E, T-PSAE-5BW-E(White) / T-PSA-5BB-E, T-PSAE-5BB-E(Black)			
Air filter, Q'ty			Pocket plastic net x 1(Washable)			
Remote control (option)			wired:RC-EX3A, RC-E5, RCH-E3 wireless:RCN-T-5BW-E2, RCN-T-5BB-E2			

The values are for simultaneous Multi operation.

R32		Micro Inverter				
Set model name		FDT100VSAVPVH	FDT125VSAVPVH	FDT140VSAVPVH	FDT140VSAVTVH	
		Twin		Triple		
Indoor unit		FDT50VH x 2	FDT60VH x 2	FDT71VH x 2	FDT50VH x 3	
Outdoor unit		FDC100VSA-W	FDC125VSA-W	FDC140VSA-W	FDC140VSA-W	
Power source		3 Phase 380-415V, 50Hz / 380V, 60Hz				
Nominal cooling capacity (Min~Max)	kW	10.0 (4.0 ~ 11.2)	12.5 (5.0 ~ 14.0)	13.6 (5.0 ~ 14.5)	13.6 (5.0 ~ 14.5)	
Nominal heating capacity (Min~Max)	kW	11.2 (4.0 ~ 12.5)	14.0 (4.0 ~ 16.0)	15.5 (4.0 ~ 16.5)	15.5 (4.0 ~ 16.5)	
Power consumption	Cooling/Heating	2.82 / 2.73	3.79 / 3.31	4.22 / 3.57	4.22 / 3.57	
EER/COP	Cooling/Heating	3.55 / 4.11	3.30 / 4.23	3.22 / 4.34	3.22 / 3.88	
Inrush current	A	5	5	5	5	
Max. current		15	15	15	15	
Sound power level*1	Indoor <sup>3</sup>	Cooling/Heating	55 / 56	58 / 59	59 / 60	55 / 56
	Outdoor	Cooling/Heating	69 / 70	71 / 71	72 / 73	72 / 73
Sound pressure level*1	Indoor <sup>3</sup>	Cooling (P-Hi/Hi/Me/Lo)	41 / 33 / 30 / 26	44 / 34 / 30 / 27	46 / 34 / 31 / 26	41 / 33 / 30 / 26
		Heating (P-Hi/Hi/Me/Lo)	42 / 33 / 28 / 20	44 / 34 / 30 / 23	46 / 34 / 31 / 26	42 / 33 / 28 / 20
Air flow	Outdoor	Cooling/Heating	54 / 55	54 / 56	56 / 58	56 / 58
		Cooling (P-Hi/Hi/Me/Lo)	22 / 16 / 13 / 10	26 / 17 / 14 / 11	28 / 18 / 15 / 12	22 / 16 / 13 / 10
Exterior dimensions	Indoor	HeightxWidthxDepth	mm	Unit: 236 x 840 x 840 Panel: 35 x 950 x 950		
				845 x 970 x 370		
Net weight	Indoor	kg	24(Unit:19 Standard Panel:5)		24(Unit:19 Standard Panel:5)	
			26(Unit:21 Standard Panel:5)		24(Unit:19 Standard Panel:5)	
Ref.piping size	Liquid/Gas	ømm	9.52(3/8") / 15.88(5/8")			
Refrigerant line (one way) length		m	Max.50			
Vertical height differences	Outdoor is higher/lower	m	Max.50 / Max.15			
Outdoor operating temperature range	Cooling	°CDB	-15~50*2			
	Heating	°CWB	-20~20			
Panel			T-PSA-5BW-E, T-PSAE-5BW-E(White) / T-PSA-5BB-E, T-PSAE-5BB-E(Black)			
Air filter, Q'ty			Pocket plastic net x 1(Washable)			
Remote control (option)			wired:RC-EX3A, RC-E5, RCH-E3 wireless:RCN-T-5BW-E2, RCN-T-5BB-E2			

## SPECIFICATIONS -FDT-

The values are for simultaneous Multi operation.

R32		Micro Inverter			
Set model name		FDT200VSAWPVH	FDT250VSAWPVH	FDT280VSAWPVH	
		Twin			
Indoor unit		FDT100VH x 2	FDT125VH x 2	FDT140VH x 2	
Outdoor unit		FDC200VSA-W	FDC250VSA-W	FDC280VSA-W	
Power source		3 Phase 380-415V, 50Hz / 380V, 60Hz			
Nominal cooling capacity (Min~Max)	kW	20.0 ( 6.8 ~ 22.4 )	25.0 ( 6.8 ~ 28.0 )	27.0 ( 7.5 ~ 31.5 )	
Nominal heating capacity (Min~Max)	kW	22.4 ( 6.6 ~ 25.0 )	28.0 ( 5.7 ~ 31.5 )	30.0 ( 6.3 ~ 33.5 )	
Power consumption	Cooling/Heating	5.48 / 5.27	8.20 / 7.37	9.11 / 8.95	
EER/COP	Cooling/Heating	3.65 / 4.25	3.05 / 3.80	2.96 / 3.35	
Inrush current	A	5	5	5	
Max. current		19	20	20	
Sound power level*1	Indoor*3	Cooling/Heating	62 / 62	63 / 64	63 / 64
	Outdoor	Cooling/Heating	72 / 74	73 / 75	75 / 77
Sound pressure level*1	Indoor*3	Cooling (P-Hi/Hi/Me/Lo)	47 / 39 / 36 / 30	48 / 41 / 39 / 31	48 / 42 / 39 / 32
	Outdoor	Heating (P-Hi/Hi/Me/Lo)	47 / 39 / 36 / 29	48 / 41 / 38 / 31	48 / 41 / 38 / 31
Air flow	Indoor*3	Cooling (P-Hi/Hi/Me/Lo)	58 / 59	58 / 62	61 / 63
	Outdoor	Heating (P-Hi/Hi/Me/Lo)	37 / 26 / 23 / 17	38 / 28 / 25 / 18	38 / 29 / 26 / 19
Exterior dimensions	Indoor	HeightxWidthxDepth	Unit: 298 x 840 x 840 Panel: 35 x 950 x 950		
	Outdoor		1,505 x 970 x 370		
Net weight	Indoor		30(Unit:25 Standard Panel:5)		
	Outdoor		144	145	155
Ref.piping size	Liquid/Gas	ømm	9.52(3/8") / 22.22(7/8")		
Refrigerant line (one way) length		m	Max.70		Max.60
Vertical height differences	Outdoor is higher/lower	m	Max.50*4 / Max.15		
Outdoor operating temperature range	Cooling	°CDB	-15~50*2		
	Heating	°CWB	-20~20		
Panel			T-PSA-5BW-E, T-PSAE-5BW-E(White) / T-PSA-5BB-E, T-PSAE-5BB-E(Black)		
Air filter, Q'ty			Pocket plastic net x 1(Washable)		
Remote control (option)			wired:RC-EX3A, RC-E5, RCH-E3 wireless:RCN-T-5BW-E2, RCN-T-5BB-E2		

The values are for simultaneous Multi operation.

R32		Micro Inverter			
Set model name		FDT200VSAWTVH	FDT200VSAWDVH	FDT250VSAWDVH	FDT280VSAWDVH
		Triple			
Indoor unit		FDT71VH x 3	FDT50VH x 4	FDT60VH x 4	FDT71VH x 4
Outdoor unit		FDC200VSA-W	FDC200VSA-W	FDC250VSA-W	FDC280VSA-W
Power source		3 Phase 380-415V, 50Hz / 380V, 60Hz			
Nominal cooling capacity (Min~Max)	kW	20.0 ( 7.6 ~ 22.4 )	20.0 ( 6.8 ~ 22.4 )	25.0 ( 5.2 ~ 28.0 )	27.0 ( 7.5 ~ 31.5 )
Nominal heating capacity (Min~Max)	kW	22.4 ( 6.6 ~ 25.0 )	22.4 ( 6.6 ~ 25.0 )	28.0 ( 7.2 ~ 31.5 )	30.0 ( 6.3 ~ 33.5 )
Power consumption	Cooling/Heating	5.56 / 5.27	5.78 / 5.80	7.30 / 6.80	7.77 / 8.60
EER/COP	Cooling/Heating	3.60 / 4.25	3.46 / 3.86	3.42 / 4.12	3.47 / 3.49
Inrush current	A	5	5	5	5
Max. current		19	19	20	20
Sound power level*1	Indoor*3	Cooling/Heating	59 / 60	55 / 56	58 / 59
	Outdoor	Cooling/Heating	72 / 74	72 / 74	73 / 75
Sound pressure level*1	Indoor*3	Cooling (P-Hi/Hi/Me/Lo)	46 / 34 / 31 / 26	41 / 33 / 30 / 26	44 / 34 / 30 / 27
	Outdoor	Heating (P-Hi/Hi/Me/Lo)	46 / 34 / 31 / 26	42 / 33 / 28 / 20	44 / 34 / 30 / 23
Air flow	Indoor*3	Cooling (P-Hi/Hi/Me/Lo)	58 / 59	58 / 59	58 / 62
	Outdoor	Heating (P-Hi/Hi/Me/Lo)	28 / 18 / 15 / 12	22 / 16 / 13 / 10	26 / 17 / 14 / 11
Exterior dimensions	Indoor	HeightxWidthxDepth	Unit: 236 x 840 x 840 Panel: 35 x 950 x 950		
	Outdoor		1,505 x 970 x 370		
Net weight	Indoor		26(Unit:21 Standard Panel:5)	24(Unit:19 Standard Panel:5)	26(Unit:21 Standard Panel:5)
	Outdoor		144	145	155
Ref.piping size	Liquid/Gas	ømm	9.52(3/8") / 22.22(7/8")		
Refrigerant line (one way) length		m	Max.70		Max.60
Vertical height differences	Outdoor is higher/lower	m	Max.50*4 / Max.15		
Outdoor operating temperature range	Cooling	°CDB	-15~50*2		
	Heating	°CWB	-20~20		
Panel			T-PSA-5BW-E, T-PSAE-5BW-E(White) / T-PSA-5BB-E, T-PSAE-5BB-E(Black)		
Air filter, Q'ty			Pocket plastic net x 1(Washable)		
Remote control (option)			wired:RC-EX3A, RC-E5, RCH-E3 wireless:RCN-T-5BW-E2, RCN-T-5BB-E2		

### NOTES:

The data are measured under the following conditions(R32 : ISO-T1, -H1 / , R410A:ISO-T1).

Cooling:Indoor temp. of 27°CDB, 19°CWB, and outdoor temp. of 35°CDB. Heating:Indoor temp. of 20°CDB, and outdoor temp. of 7°CDB, 6°CWB.

\*1 : Indicates the value in an anechoic chamber. During operation these values are somewhat higher due to ambient conditions.

\*2 : If a cooling operation is conducted when the outdoor air temperature is -5°C or lower, the outdoor unit should be installed at a place where it is not influenced by natural wind. If wind blows, the low pressure will drop and compressor frequency will increase, this will cause the capacity to drop and may cause the unit to break down.

\*3 : The values are for one indoor unit operation. (Multi system only)

\*4 : In case of following conditions:Max.50m(Outdoor unit is higher & Outdoor temperature ≤ 43°C), Max.30m(Outdoor unit is higher & Outdoor temperature > 43°C)

R410A		Micro Inverter		
Set model name		FDT100VNAVH	FDT125VNAVH	FDT140VNAVH
Indoor unit		FDT100VH	FDT125VH	FDT140VH
Outdoor unit		FDC100VNA	FDC125VNA	FDC140VNA
Power source		1 Phase 220-240V, 50Hz / 220V, 60Hz		
Nominal cooling capacity (Min~Max)	kW	10.0 ( 4.0 ~ 11.2 )	12.5 ( 5.0 ~ 14.0 )	13.6 ( 5.0 ~ 14.5 )
Nominal heating capacity (Min~Max)	kW	11.2 ( 4.0 ~ 12.5 )	14.0 ( 4.0 ~ 16.0 )	15.5 ( 4.0 ~ 16.5 )
Power consumption	Cooling/Heating	2.73 / 2.64	4.05 / 3.74	5.09 / 4.43
EER/COP	Cooling/Heating	3.26 / 4.26	3.09 / 3.74	2.67 / 3.50
Inrush current		5	5	5
Max. current		24	24	24
Sound power level*1	Indoor	Cooling/Heating	62 / 62	63 / 64
	Outdoor	Cooling/Heating	70 / 70	73 / 73
Sound pressure level*1	Indoor	Cooling (P-Hi/Hi/Me/Lo)	47 / 39 / 36 / 30	48 / 41 / 39 / 31
		Heating (P-Hi/Hi/Me/Lo)	47 / 39 / 36 / 29	48 / 41 / 38 / 31
	Outdoor	Cooling/Heating	54 / 56	55 / 57
				57 / 59
Air flow	Indoor	Cooling (P-Hi/Hi/Me/Lo)	37 / 26 / 23 / 17	38 / 28 / 25 / 18
		Heating (P-Hi/Hi/Me/Lo)	37 / 26 / 23 / 17	38 / 28 / 25 / 18
	Outdoor	Cooling/Heating	75 / 73	75 / 73
Exterior dimensions	Indoor	HeightxWidthxDepth	Unit: 298 x 840 x 840 Panel: 35 x 950 x 950	
	Outdoor		845 x 970 x 370	
Net weight	Indoor		30(Unit:25 Standard Panel:5)	
	Outdoor		80	
Ref.piping size	Liquid/Gas	ømm	9.52(3/8") / 15.88(5/8")	
Refrigerant line (one way) length		m	Max.50	
Vertical height differences	Outdoor is higher/lower	m	Max.50 / Max.15	
Outdoor operating temperature range	Cooling	°CDB	-15~50*2	
	Heating	°CWB	-20~20	
Panel			T-PSA-5BW-E, T-PSAE-5BW-E(White) / T-PSA-5BB-E, T-PSAE-5BB-E(Black)	
Air filter, Q'ty			Pocket plastic net x 1(Washable)	
Remote control (option)			wired:RC-EX3A, RC-E5, RCH-E3 wireless:RCN-T-5BW-E2, RCN-T-5BB-E2	

R410A		Micro Inverter		
Set model name		FDT100VSAVH	FDT125VSAVH	FDT140VSAVH
Indoor unit		FDT100VH	FDT125VH	FDT140VH
Outdoor unit		FDC100VSA	FDC125VSA	FDC140VSA
Power source		3 Phase 380-415V, 50Hz / 380V, 60Hz		
Nominal cooling capacity (Min~Max)	kW	10.0 ( 4.0 ~ 11.2 )	12.5 ( 5.0 ~ 14.0 )	13.6 ( 5.0 ~ 14.5 )
Nominal heating capacity (Min~Max)	kW	11.2 ( 4.0 ~ 12.5 )	14.0 ( 4.0 ~ 16.0 )	15.5 ( 4.0 ~ 16.5 )
Power consumption	Cooling/Heating	2.73 / 2.63	4.05 / 3.74	5.09 / 4.43
EER/COP	Cooling/Heating	3.66 / 4.26	3.09 / 3.74	2.67 / 3.50
Inrush current		5	5	5
Max. current		15	15	15
Sound power level*1	Indoor	Cooling/Heating	62 / 62	63 / 64
	Outdoor	Cooling/Heating	70 / 70	73 / 73
Sound pressure level*1	Indoor	Cooling (P-Hi/Hi/Me/Lo)	47 / 39 / 36 / 30	48 / 41 / 39 / 31
		Heating (P-Hi/Hi/Me/Lo)	47 / 39 / 36 / 29	48 / 41 / 38 / 31
	Outdoor	Cooling/Heating	54 / 56	55 / 57
				57 / 59
Air flow	Indoor	Cooling (P-Hi/Hi/Me/Lo)	37 / 26 / 23 / 17	38 / 28 / 25 / 18
		Heating (P-Hi/Hi/Me/Lo)	37 / 26 / 23 / 17	38 / 28 / 25 / 18
	Outdoor	Cooling/Heating	75 / 73	75 / 73
Exterior dimensions	Indoor	HeightxWidthxDepth	Unit: 298 x 840 x 840 Panel: 35 x 950 x 950	
	Outdoor		845 x 970 x 370	
Net weight	Indoor		30(Unit:25 Standard Panel:5)	
	Outdoor		82	
Ref.piping size	Liquid/Gas	ømm	9.52(3/8") / 15.88(5/8")	
Refrigerant line (one way) length		m	Max.50	
Vertical height differences	Outdoor is higher/lower	m	Max.50 / Max.15	
Outdoor operating temperature range	Cooling	°CDB	-15~50*2	
	Heating	°CWB	-20~20	
Panel			T-PSA-5BW-E, T-PSAE-5BW-E(White) / T-PSA-5BB-E, T-PSAE-5BB-E(Black)	
Air filter, Q'ty			Pocket plastic net x 1(Washable)	
Remote control (option)			wired:RC-EX3A, RC-E5, RCH-E3 wireless:RCN-T-5BW-E2, RCN-T-5BB-E2	

## SPECIFICATIONS -FDT-

The values are for simultaneous Multi operation.

R410A		Micro Inverter				
Set model name		FDT100VNAPVH	FDT125VNAPVH	FDT140VNAPVH	FDT140VNATVH	
		Twin		Triple		
Indoor unit		FDT50VH x 2	FDT60VH x 2	FDT71VH x 2	FDT50VH x 3	
Outdoor unit		FDC100VNA	FDC125VNA	FDC140VNA	FDC140VNA	
Power source		1 Phase 220-240V, 50Hz / 220V, 60Hz				
Nominal cooling capacity (Min~Max)	kW	10.0 ( 4.0 ~ 11.2 )	12.5 ( 5.0 ~ 14.0 )	13.6 ( 5.0 ~ 14.5 )	13.6 ( 5.0 ~ 14.5 )	
Nominal heating capacity (Min~Max)	kW	11.2 ( 4.0 ~ 12.5 )	14.0 ( 4.0 ~ 16.0 )	15.5 ( 4.0 ~ 16.5 )	15.5 ( 4.0 ~ 16.5 )	
Power consumption	Cooling/Heating	2.82 / 2.90	3.79 / 3.31	4.22 / 3.72	4.22 / 3.29	
EER/COP	Cooling/Heating	3.55 / 3.86	3.30 / 4.23	3.22 / 4.17	3.22 / 4.71	
Inrush current		5	5	5	5	
Max. current		24	24	24	24	
Sound power level*1	Indoor <sup>3</sup>	Cooling/Heating	55 / 56	58 / 59	59 / 60	55 / 56
	Outdoor	Cooling/Heating	70 / 70	71 / 71	73 / 73	73 / 73
Sound pressure level*1	Indoor <sup>3</sup>	Cooling (P-Hi/Hi/Me/Lo)	41 / 33 / 30 / 26	44 / 34 / 30 / 27	46 / 34 / 31 / 26	41 / 33 / 30 / 26
	Outdoor	Heating (P-Hi/Hi/Me/Lo)	42 / 33 / 28 / 20	44 / 34 / 30 / 23	46 / 34 / 31 / 26	42 / 33 / 28 / 20
Air flow	Indoor <sup>3</sup>	Cooling/Heating	54 / 56	55 / 57	57 / 59	57 / 59
	Outdoor	Cooling (P-Hi/Hi/Me/Lo)	22 / 16 / 13 / 10	26 / 17 / 14 / 11	28 / 18 / 15 / 12	22 / 16 / 13 / 10
		Heating (P-Hi/Hi/Me/Lo)	22 / 16 / 13 / 10	26 / 17 / 14 / 11	28 / 18 / 15 / 12	22 / 16 / 13 / 10
Exterior dimensions	Indoor	HeightxWidthxDepth	Unit: 236 x 840 x 840 Panel: 35 x 950 x 950			
	Outdoor		845 x 970 x 370			
Net weight	Indoor		24(Unit:19 Standard Panel:5)	26(Unit:21 Standard Panel:5)	24(Unit:19 Standard Panel:5)	
	Outdoor		80			
Ref.piping size	Liquid/Gas		9.52(3/8") / 15.88(5/8")			
Refrigerant line (one way) length			Max.50			
Vertical height differences	Outdoor is higher/lower		Max.50 / Max.15			
Outdoor operating temperature range	Cooling	°CDB	-15~50*2			
	Heating	°CWB	-20~20			
Panel			T-PSA-5BW-E, T-PSAE-5BW-E(White) / T-PSA-5BB-E, T-PSAE-5BB-E(Black)			
Air filter, Q'ty			Pocket plastic net x 1(Washable)			
Remote control (option)			wired:RC-EX3A, RC-E5, RCH-E3 wireless:RCN-T-5BW-E2, RCN-T-5BB-E2			

The values are for simultaneous Multi operation.

R410A		Micro Inverter				
Set model name		FDT100VSAPVH	FDT125VSAPVH	FDT140VSAPVH	FDT140VSATVH	
		Twin		Triple		
Indoor unit		FDT50VH x 2	FDT60VH x 2	FDT71VH x 2	FDT50VH x 3	
Outdoor unit		FDC100VSA	FDC125VSA	FDC140VSA	FDC140VSA	
Power source		3 Phase 380-415V, 50Hz / 380V, 60Hz				
Nominal cooling capacity (Min~Max)	kW	10.0 ( 4.0 ~ 11.2 )	12.5 ( 5.0 ~ 14.0 )	13.6 ( 5.0 ~ 14.5 )	13.6 ( 5.0 ~ 14.5 )	
Nominal heating capacity (Min~Max)	kW	11.2 ( 4.0 ~ 12.5 )	14.0 ( 4.0 ~ 16.0 )	15.5 ( 4.0 ~ 16.5 )	15.5 ( 4.0 ~ 16.5 )	
Power consumption	Cooling/Heating	2.82 / 2.90	3.79 / 3.31	4.22 / 3.72	4.22 / 3.29	
EER/COP	Cooling/Heating	3.55 / 3.86	3.30 / 4.23	3.22 / 4.17	3.22 / 4.71	
Inrush current		5	5	5	5	
Max. current		15	15	15	15	
Sound power level*1	Indoor <sup>3</sup>	Cooling/Heating	55 / 56	58 / 59	59 / 60	55 / 56
	Outdoor	Cooling/Heating	70 / 70	71 / 71	73 / 73	73 / 73
Sound pressure level*1	Indoor <sup>3</sup>	Cooling (P-Hi/Hi/Me/Lo)	41 / 33 / 30 / 26	44 / 34 / 30 / 27	46 / 34 / 31 / 26	41 / 33 / 30 / 26
	Outdoor	Heating (P-Hi/Hi/Me/Lo)	42 / 33 / 28 / 20	44 / 34 / 30 / 23	46 / 34 / 31 / 26	42 / 33 / 28 / 20
Air flow	Indoor <sup>3</sup>	Cooling/Heating	54 / 56	55 / 57	57 / 59	57 / 59
	Outdoor	Cooling (P-Hi/Hi/Me/Lo)	22 / 16 / 13 / 10	26 / 17 / 14 / 11	28 / 18 / 15 / 12	22 / 16 / 13 / 10
		Heating (P-Hi/Hi/Me/Lo)	22 / 16 / 13 / 10	26 / 17 / 14 / 11	28 / 18 / 15 / 12	22 / 16 / 13 / 10
Exterior dimensions	Indoor	HeightxWidthxDepth	Unit: 236 x 840 x 840 Panel: 35 x 950 x 950			
	Outdoor		845 x 970 x 370			
Net weight	Indoor		24(Unit:19 Standard Panel:5)	26(Unit:21 Standard Panel:5)	24(Unit:19 Standard Panel:5)	
	Outdoor		82			
Ref.piping size	Liquid/Gas		9.52(3/8") / 15.88(5/8")			
Refrigerant line (one way) length			Max.50			
Vertical height differences	Outdoor is higher/lower		Max.50 / Max.15			
Outdoor operating temperature range	Cooling	°CDB	-15~50*2			
	Heating	°CWB	-20~20			
Panel			T-PSA-5BW-E, T-PSAE-5BW-E(White) / T-PSA-5BB-E, T-PSAE-5BB-E(Black)			
Air filter, Q'ty			Pocket plastic net x 1(Washable)			
Remote control (option)			wired:RC-EX3A, RC-E5, RCH-E3 wireless:RCN-T-5BW-E2, RCN-T-5BB-E2			

### NOTES:

The data are measured under the following conditions(R410A : ISO-T1 ).

Cooling:Indoor temp. of 27°CDB, 19°CWB, and outdoor temp. of 35°CDB. Heating:Indoor temp. of 20°CDB, and outdoor temp. of 7°CDB, 6°CWB.

\*1 : Indicates the value in an anechoic chamber. During operation these values are somewhat higher due to ambient conditions.

\*2 : If a cooling operation is conducted when the outdoor air temperature is -5°C or lower, the outdoor unit should be installed at a place where it is not influenced by natural wind. If wind blows, the low pressure will drop and compressor frequency will increase, this will cause the capacity to drop and may cause the unit to break down.

\*3 : The values are for one indoor unit operation. (Multi system only)

The values are for simultaneous Multi operation.

R410A			Micro Inverter		
Set model name			FDT200VSAPVH		FDT250VSAPVH
			Twin		
Indoor unit			FDT100VH x 2		FDT125VH x 2
Outdoor unit			FDC200VSA		FDC250VSA
Power source			3 Phase 380-415V, 50Hz / 380V, 60Hz		
Nominal cooling capacity (Min~Max)	kW		19.0 ( 5.2 ~ 22.4 )		24.0 ( 6.9 ~ 28.0 )
Nominal heating capacity (Min~Max)	kW		22.4 ( 3.3 ~ 25.0 )		27.0 ( 5.5 ~ 31.5 )
Power consumption	Cooling/Heating	kW	6.25 / 6.02		8.36 / 7.15
EER/COP	Cooling/Heating		3.04 / 3.72		2.87 / 3.78
Inrush current		A	5		5
Max. current			20		21
Sound power level*1	Indoor <sup>3</sup>	Cooling/Heating	62 / 62		63 / 64
	Outdoor	Cooling/Heating	72 / 74		73 / 75
Sound pressure level*1	Indoor <sup>3</sup>	Cooling (P-Hi/Hi/Me/Lo)	47 / 39 / 36 / 30		48 / 41 / 39 / 31
		Heating (P-Hi/Hi/Me/Lo)	47 / 39 / 36 / 29		48 / 41 / 38 / 31
Air flow	Indoor <sup>3</sup>	Cooling/Heating	58 / 59		59 / 62
	Outdoor	Cooling/Heating	37 / 26 / 23 / 17		38 / 28 / 25 / 18
Exterior dimensions	Indoor	HeightxWidthxDepth	mm		Unit: 298 x 840 x 840 Panel: 35 x 950 x 950
	Outdoor		1,300 x 970 x 370		1,505 x 970 x 370
Net weight	Indoor		kg		30(Unit:25 Standard Panel:5)
	Outdoor		115		143
Ref.piping size	Liquid/Gas	ømm	9.52(3/8") / 22.22(7/8")		12.7(1/2") / 22.22(7/8")
Refrigerant line (one way) length		m	Max.70		
Vertical height differences	Outdoor is higher/lower	m	Max.30 / Max.15		
Outdoor operating temperature range	Cooling	°CDB	-15~50*2		
	Heating	°CWB	-15~20		
Panel			T-PSA-5BW-E, T-PSAE-5BW-E(White) / T-PSA-5BB-E, T-PSAE-5BB-E(Black)		
Air filter, Q'ty			Pocket plastic net x 1(Washable)		
Remote control (option)			wired:RC-EX3A, RC-E5, RCH-E3 wireless:RCN-T-5BW-E2, RCN-T-5BB-E2		

The values are for simultaneous Multi operation.

R410A			Micro Inverter		
Set model name			FDT200VSATVH		FDT250VSADVH
			Triple		
Indoor unit			FDT71VH x 3		FDT50VH x 4
Outdoor unit			FDC200VSA		FDC250VSA
Power source			3 Phase 380-415V, 50Hz / 380V, 60Hz		
Nominal cooling capacity (Min~Max)	kW		19.0 ( 5.2 ~ 22.4 )		24.0 ( 6.9 ~ 28.0 )
Nominal heating capacity (Min~Max)	kW		22.4 ( 3.3 ~ 25.0 )		27.0 ( 5.5 ~ 31.5 )
Power consumption	Cooling/Heating	kW	6.01 / 5.76		7.43 / 6.83
EER/COP	Cooling/Heating		3.16 / 3.89		3.23 / 3.95
Inrush current		A	5		5
Max. current			20		21
Sound power level*1	Indoor <sup>3</sup>	Cooling/Heating	59 / 60		58 / 59
	Outdoor	Cooling/Heating	72 / 74		73 / 75
Sound pressure level*1	Indoor <sup>3</sup>	Cooling (P-Hi/Hi/Me/Lo)	46 / 34 / 31 / 26		44 / 34 / 30 / 27
		Heating (P-Hi/Hi/Me/Lo)	46 / 34 / 31 / 26		44 / 34 / 30 / 23
Air flow	Indoor <sup>3</sup>	Cooling/Heating	58 / 59		59 / 62
	Outdoor	Cooling/Heating	28 / 18 / 15 / 12		26 / 17 / 14 / 11
Exterior dimensions	Indoor	HeightxWidthxDepth	mm		Unit: 236 x 840 x 840 Panel: 35 x 950 x 950
	Outdoor		1,300 x 970 x 370		1,505 x 970 x 370
Net weight	Indoor		kg		26(Unit:21 Standard Panel:5)
	Outdoor		115		143
Ref.piping size	Liquid/Gas	ømm	9.52(3/8") / 22.22(7/8")		12.7(1/2") / 22.22(7/8")
Refrigerant line (one way) length		m	Max.70		
Vertical height differences	Outdoor is higher/lower	m	Max.30 / Max.15		
Outdoor operating temperature range	Cooling	°CDB	-15~50*2		
	Heating	°CWB	-15~20		
Panel			T-PSA-5BW-E, T-PSAE-5BW-E(White) / T-PSA-5BB-E, T-PSAE-5BB-E(Black)		
Air filter, Q'ty			Pocket plastic net x 1(Washable)		
Remote control (option)			wired:RC-EX3A, RC-E5, RCH-E3 wireless:RCN-T-5BW-E2, RCN-T-5BB-E2		

## SPECIFICATIONS -FDT-

R32			Standard Inverter			
Set model name			FDT71VNPVH	FDT90VNPVH	FDT100VNPVH	FDT125VNPVH
Indoor unit			FDT71VH	FDT100VH	FDT100VH	FDT125VH
Outdoor unit			FDC71VNP-W	FDC90VNP-W	FDC100VNP-W	FDC125VNP-W
Power source			1 Phase 220-240V, 50Hz / 220V, 60Hz			
Nominal cooling capacity (Min~Max)			kW 7.1 ( 1.5 ~ 7.3 )	9.0 ( 2.1 ~ 9.5 )	10.0 ( 2.1 ~ 10.2 )	12.1 ( 5.0 ~ 12.1 )
Nominal heating capacity (Min~Max)			kW 7.1 ( 1.1 ~ 7.3 )	9.0 ( 1.7 ~ 9.5 )	10.0 ( 1.7 ~ 10.4 )	12.1 ( 4.0 ~ 13.3 )
Power consumption			Cooling/Heating kW 2.31 / 1.73	2.48 / 1.90	2.84 / 2.33	3.69 / 3.20
EER/COP			Cooling/Heating 3.07 / 4.10	3.63 / 4.74	3.52 / 4.29	3.28 / 3.78
Inrush current			A 5	5	5	5
Max. current			15.8	19	19	18
Sound power level*1	Indoor	Cooling/Heating	59 / 60	62 / 62	62 / 62	63 / 64
	Outdoor	Cooling/Heating	67 / 67	67 / 66	68 / 67	73 / 72
Sound pressure level*1	Indoor	Cooling (P-Hi/Hi/Me/Lo)	dB(A) 46 / 34 / 31 / 26	47 / 39 / 36 / 30	47 / 39 / 36 / 30	48 / 41 / 39 / 31
		Heating (P-Hi/Hi/Me/Lo)		47 / 39 / 36 / 29	47 / 39 / 36 / 29	48 / 41 / 38 / 31
	Outdoor	Cooling/Heating	54 / 54	55 / 53	56 / 54	57 / 57
		Cooling (P-Hi/Hi/Me/Lo)	m³/min 28 / 18 / 15 / 12	37 / 26 / 23 / 17	36 / 26 / 23 / 17	38 / 28 / 25 / 18
Air flow	Indoor	Heating (P-Hi/Hi/Me/Lo)	28 / 18 / 15 / 12	37 / 26 / 23 / 17	36 / 26 / 23 / 17	38 / 28 / 25 / 18
		Cooling/Heating	42 / 42	59 / 55	63 / 55	75 / 79
Exterior dimensions	Indoor	HeightxWidthxDepth	mm	Unit: 236 x 840 x 840 Panel: 35 x 950 x 950		
	Outdoor			640 x 800(+71) x 290	750 x 880(+88) x 340	845 x 970 x 370
Net weight	Indoor		kg	26(Unit:21 Standard Panel:5)		
	Outdoor			45	57	73
Ref.piping size	Liquid/Gas	ømm	6.35(1/4") / 12.7(1/2")			
Refrigerant line (one way) length			m	Max.30		
Vertical height differences			Outdoor is higher/lower	m Max.20 / Max.20		
Outdoor operating temperature range	Cooling	°CDB	-15~46*2			
	Heating	°CWB	-15~20			
Panel			T-PSA-5BW-E, T-PSAE-5BW-E(White) / T-PSA-5BB-E, T-PSAE-5BB-E(Black)			
Air filter, Q'ty			Pocket Plastic net x1(Washable)			
Remote control (option)			wired:RC-EX3A, RC-E5, RCH-E3 wireless:RCN-T-5BW-E2, RCN-T-5BB-E2			

R410A			Standard Inverter			
Set model name			FDT71VNPVH	FDT90VNP1VH	FDT100VNP1VH	
Indoor unit			FDT71VH	FDT100VH	FDT100VH	
Outdoor unit			FDC71VNP	FDC90VNP1	FDC100VNP	
Power source			1 Phase 220-240V, 50Hz / 220V, 60Hz			
Nominal cooling capacity (Min~Max)			kW 7.1 ( 1.4 ~ 7.1 )	9.0 ( 1.9 ~ 9.0 )	10.0 ( 2.8 ~ 11.2 )	
Nominal heating capacity (Min~Max)			kW 7.1 ( 1.0 ~ 7.1 )	9.0 ( 1.5 ~ 9.0 )	11.2 ( 2.5 ~ 12.5 )	
Power consumption			Cooling/Heating kW 2.31 / 1.73	2.67 / 2.19	2.76 / 2.84	
EER/COP			Cooling/Heating 3.07 / 4.10	3.37 / 4.11	3.62 / 3.94	
Inrush current			A 5	5	5	
Max. current			14.5	18	21	
Sound power level*1	Indoor	Cooling/Heating	59 / 60	62 / 62	62 / 62	
	Outdoor	Cooling/Heating	67 / 67	69 / 69	70 / 70	
Sound pressure level*1	Indoor	Cooling (P-Hi/Hi/Me/Lo)	dB(A) 46 / 34 / 31 / 26	47 / 39 / 36 / 30	47 / 39 / 36 / 30	
		Heating (P-Hi/Hi/Me/Lo)		47 / 39 / 36 / 29	47 / 39 / 36 / 29	
	Outdoor	Cooling/Heating	54 / 54	57 / 55	57 / 61	
		Cooling (P-Hi/Hi/Me/Lo)	m³/min 28 / 18 / 15 / 12	37 / 26 / 23 / 17	37 / 26 / 23 / 17	
Air flow	Indoor	Heating (P-Hi/Hi/Me/Lo)	28 / 18 / 15 / 12	37 / 26 / 23 / 17	37 / 26 / 23 / 17	
		Cooling/Heating	36 / 36	63 / 49.5	75 / 79	
Exterior dimensions	Indoor	HeightxWidthxDepth	mm	Unit: 236 x 840 x 840 Panel: 35 x 950 x 950		
	Outdoor			640 x 800(+71) x 290	750 x 880(+88) x 340	845 x 970 x 370
Net weight	Indoor		kg	26(Unit:21 Standard Panel:5)		
	Outdoor			45	57	70
Ref.piping size	Liquid/Gas	ømm	6.35(1/4") / 12.7(1/2")			
Refrigerant line (one way) length			m	Max.30		
Vertical height differences			Outdoor is higher/lower	m Max.20 / Max.20		
Outdoor operating temperature range	Cooling	°CDB	-15~46*2			
	Heating	°CWB	-15~20			
Panel			T-PSA-5BW-E, T-PSAE-5BW-E(White) / T-PSA-5BB-E, T-PSAE-5BB-E(Black)			
Air filter, Q'ty			Pocket Plastic net x1(Washable)			
Remote control (option)			wired:RC-EX3A, RC-E5, RCH-E3 wireless:RCN-T-5BW-E2, RCN-T-5BB-E2			

### NOTES:

The data are measured under the following conditions(R32 : ISO-T1, -H1 / R410A : ISO-T1).

Cooling:Indoor temp. of 27°CDB, 19°CWB, and outdoor temp. of 35°CDB. Heating:Indoor temp. of 20°CDB, and outdoor temp. of 7°CDB, 6°CWB.

\*1 : Indicates the value in an anechoic chamber. During operation these values are somewhat higher due to ambient conditions.

\*2 : If a cooling operation is conducted when the outdoor air temperature is -5°C or lower, the outdoor unit should be installed at a place where it is not influenced by natural wind. If wind blows, the low pressure will drop and compressor frequency will increase, this will cause the capacity to drop and may cause the unit to break down.





# FDTC

## Indoor Unit Ceiling Cassette -4way Compact



FDTC 40/50/60



Draft Prevention Panel (Option)

New



- Energy Saving
- Home Leave
- Hi Power
- Silent Operation
- Flap Control
- Favourite Setting



### Remote control (option)

Wired			Wireless	
RC-EX3A	RC-E5	RCH-E3	RCN-TC-5AW-E3	

\*Not all functions available with all remote control options.

## European Design & Flat Panel

### Unique Grille Design

A grille designed with a unique structure and a clean white panel that blends with the room.

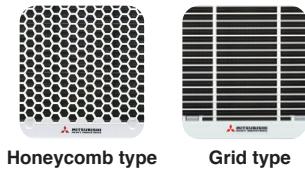

Honeycomb type      Grid type

### Integrated ceiling system design (600x600)

The weight is 14kg  
Height of thin panel and main body is 248mm allowing adequate spacing for installation.



**Thin Panel**  
**Unique Grille Design**  
**Big Louver**

**Taking OA (Outside Air) into inside**  
Fresh air can be taken in without optional parts.  
When the fresh air is insufficient, optional parts can be used.

**OA Spacer TC-OAS-E2(option)**  
**Joint Duct TC-OAD-E(option)**

Indoor Unit FDTC  
OA Spacer  
300mm  
Ceiling Surface      Panel      Joint Duct

## Draft Prevention Panel (Option)

This prevents cold/hot draft being blown directly on the user. It is possible to set Draft Prevention Panel for each air outlet.

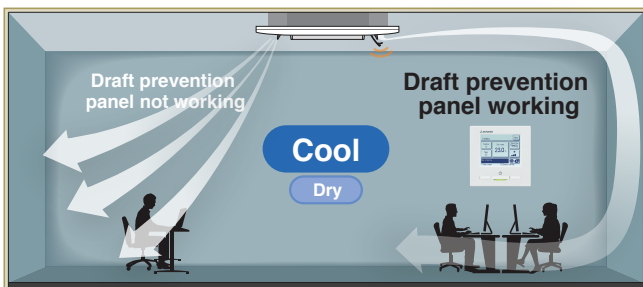

User can position panels by using the remote controller only (RC-EX3A, Wireless kit) when Draft Prevention Panel is available.

## Motion Sensor (Option)

Motion sensor is equipped in the corner of the panel and detects the presence/absence and activity of humans in a room to improve the comfort and energy saving performance of the unit.



LB-TC-5W-E

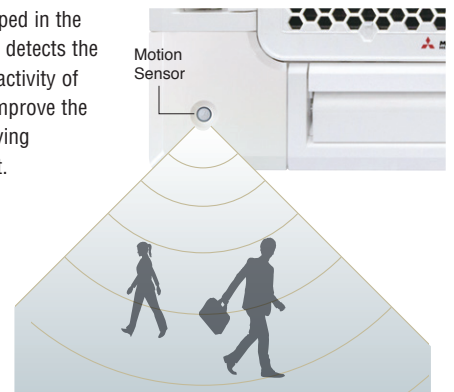

## Individual Flap Control System

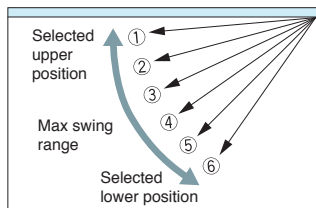

According to room temperature conditions, four directions of air flow can be controlled individually by following Flap control system. Individual flap control is available even after installation.

The flap can swing within the range of upper and lower flap position selected with wired remote control.

\* The wireless remote control is not applicable to the Individual flap control system.

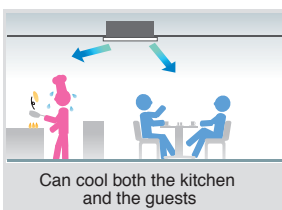
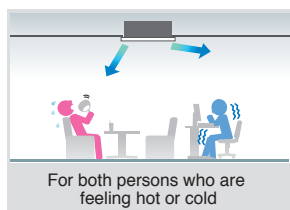
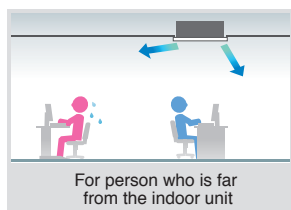

## Quieter Operation

Adopting new turbo fan and improving new heat exchanger enables noise reduction.

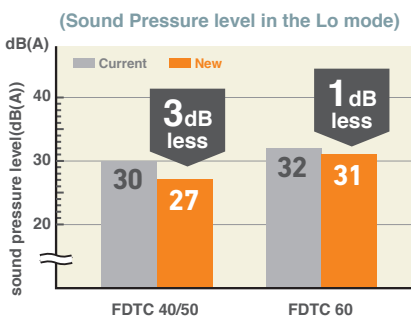

## 850mm Drain Pump

Drain can be discharged upward by 850mm from the ceiling surface close to the indoor unit. It allows a piping layout with a high degree of freedom depending on the installation location.

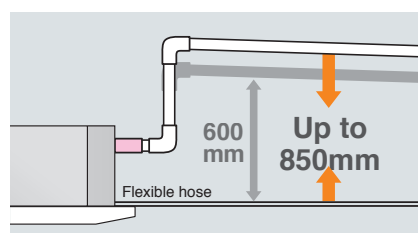

## Suitable for High ceilings

The Powerful blowout carries comfortable air flow to the floor even in high ceiling applications. It is ideal for high ceiling offices, stores, etc., with a wide, uniform air flow throughout the room.

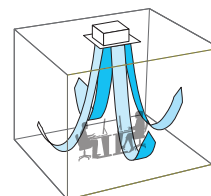

## Panel Select Pattern (Option)

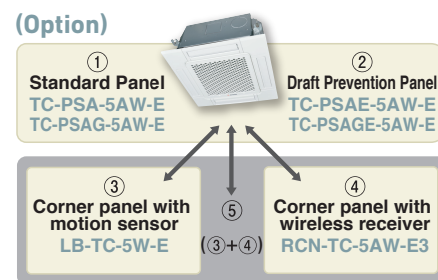

8 patterns of panel are available.

①	Standard Panel only
①+③	Standard Panel with corner panel with motion sensor
①+④	Standard Panel with corner panel with wireless receiver
①+⑤	Standard Panel with corner panel with motion sensor & corner panel with wireless receiver
②	Draft Prevention Panel only
②+③	Draft Prevention Panel with corner panel with motion sensor
②+④	Draft Prevention Panel with corner panel with wireless receiver
②+⑤	Draft Prevention Panel with corner panel with motion sensor & corner panel with wireless receiver

## OUTDOOR UNIT

		Hyper Inverter		
SRC · FDC		40~60ZSX-W1,-W2	71VNX-W	100~140VN(S)X-W
		40~60ZSX-S	71VNX	100~140VN(S)X
model				
Chargeless		15m	30m	
Height x Width x Depth (mm)		640 x 800(+71) x 290	750 x 880(+88) x 340	1,300 x 970 x 370

		Micro Inverter		
FDC		100~140VN(S)A-W	-	200·250VSA-W
		100~140VN(S)A	200VSA	250VSA
model				
Chargeless		30m		
Height x Width x Depth (mm)		845 x 970 x 370	1,300 x 970 x 370	1,505 x 970 x 370

**■ DIMENSIONS (Unit:mm) - FDTC -**

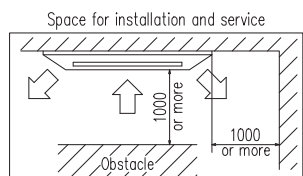
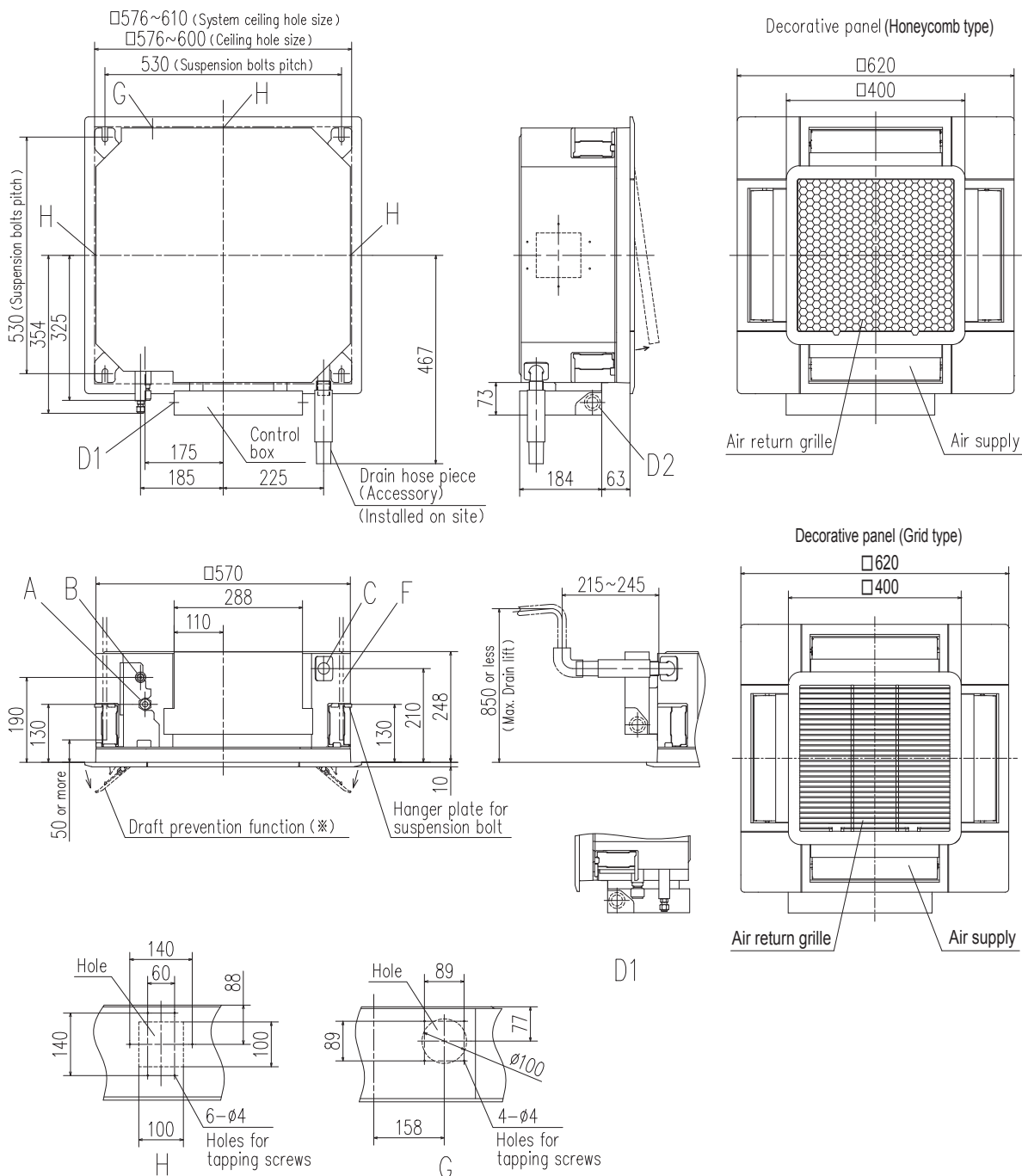

Make a space of 4000 or more between the units when installing more than one.

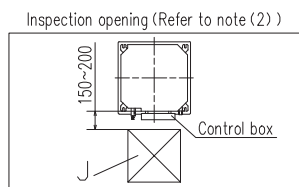

- Notes (1) The model name label is attached to the control box lid.  
 (2) This unit is designed for 2x2 grid ceiling.  
 If it is installed on a ceiling other than 2x2 grid ceiling, provide an inspection opening on the control box side.  
 (3) Draft prevention function (※) is provided on the panel TC-PSAE-5AW-E, TC-PSAGE-5AW-E only.

Symbol	Content	
A	Gas piping	φ12.7 (1/2") (Flare)
B	Liquid piping	φ6.35 (1/4") (Flare)
C	Drain piping	VP25 (O.D.32)
D1	Power supply connection	
D2	Remote control code and signal wiring connection	
F	Suspension bolts	(M10 or M8)
G	Outside air opening for ducting	(Knock out)
H	Air outlet opening for ducting	φ125 (Knock out)
J	Inspection opening	450X450

R32			Hyper Inverter		
Set model name			FDTC40ZSXW1VH	FDTC50ZSXW2VH	FDTC60ZSXW1VH
Indoor unit			FDTC40VH	FDTC50VH	FDTC60VH
Outdoor unit			SRC40ZSX-W1	SRC50ZSX-W2	SRC60ZSX-W1
Power source			1 Phase 220-240V, 50Hz / 220V, 60Hz		
Nominal cooling capacity (Min~Max)			4.0 ( 1.1 ~ 4.7 )	5.0 ( 1.1 ~ 5.6 )	5.6 ( 1.1 ~ 6.3 )
Nominal heating capacity (Min~Max)			4.5 ( 0.6 ~ 5.4 )	5.4 ( 0.6 ~ 6.3 )	6.7 ( 0.6 ~ 6.7 )
Power consumption			0.98 / 1.13	1.40 / 1.53	1.73 / 2.14
EER/COP			4.08 / 3.98	3.58 / 3.53	3.23 / 3.13
Inrush current			5	5	5
Max. current			15	15	15
Sound power level*1	Indoor	Cooling/Heating	59 / 59	59 / 59	60 / 60
	Outdoor	Cooling/Heating	63 / 62	63 / 62	65 / 65
Sound pressure level*1	Indoor	Cooling (P-Hi/Hi/Me/Lo)	44 / 40 / 35 / 27	44 / 40 / 35 / 27	46 / 42 / 38 / 31
		Heating (P-Hi/Hi/Me/Lo)	44 / 40 / 35 / 27	44 / 40 / 35 / 27	46 / 42 / 38 / 31
	Outdoor	Cooling/Heating	52 / 50	52 / 50	53 / 54
		Cooling (P-Hi/Hi/Me/Lo)	13 / 11 / 9 / 7	13 / 11 / 9 / 7	14 / 12 / 10 / 8
Air flow	Indoor	Heating (P-Hi/Hi/Me/Lo)	13 / 11 / 9 / 7	13 / 11 / 9 / 7	14 / 12 / 10 / 8
		Cooling/Heating	33 / 33	39 / 33	41.5 / 39
	Outdoor	Cooling/Heating	33 / 33	39 / 33	41.5 / 39
Exterior dimensions	Indoor	HeightxWidthxDepth	Unit: 248 x 570 x 570 Panel: 10 x 620 x 620		
	Outdoor	HeightxWidthxDepth	640 x 800(+71) x 290		
Net weight	Indoor		16.5(Unit:14 Standard Panel:2.5)		
	Outdoor		45		
Ref.piping size	Liquid/Gas	ømm	6.35(1/4") / 12.7(1/2")		
Refrigerant line (one way) length			Max.30		
Vertical height differences			Outdoor is higher/lower		
Outdoor operating temperature range			Max.20 / Max.20		
Cooling			-15~46*2		
Heating			-20~20		
Panel			TC-PSA-5AW-E, TC-PSAE-5AW-E(Honeycomb) / TC-PSAG-5AW-E, TC-PSAGE-5AW-E(Grid)		
Air filter, Q'ty			Pocket plastic net x 1(Washable)		
Remote control (option)			wired:RC-EX3A, RC-E5, RCH-E3 wireless:RCN-TC-5AW-E3		

The values are for simultaneous Multi operation.

R32			Hyper Inverter			
Set model name			FDTC71VNXWPVH	FDTC100VNXWPVH	FDTC125VNXWPVH	FDTC140VNXWTVH
Indoor unit			FDTC40VH x 2	FDTC50VH x 2	FDTC60VH x 2	FDTC50VH x 3
Outdoor unit			FDC71VNX-W	FDC100VNX-W	FDC125VNX-W	FDC140VNX-W
Power source			1 Phase 220-240V, 50Hz / 220V, 60Hz			
Nominal cooling capacity (Min~Max)			7.1 ( 3.2 ~ 8.0 )	10.0 ( 3.5 ~ 11.2 )	12.5 ( 3.5 ~ 14.0 )	14.0 ( 3.5 ~ 16.0 )
Nominal heating capacity (Min~Max)			8.0 ( 3.6 ~ 9.0 )	11.2 ( 2.7 ~ 12.5 )	14.0 ( 2.7 ~ 17.0 )	16.0 ( 2.7 ~ 18.0 )
Power consumption			1.73 / 1.83	2.60 / 3.04	3.67 / 4.05	3.96 / 4.34
EER/COP			4.12 / 4.37	3.84 / 3.69	3.41 / 3.45	3.54 / 3.69
Inrush current			5	5	5	5
Max. current			19.1	25	27	27
Sound power level*1	Indoor*3	Cooling/Heating	59 / 59	59 / 59	60 / 60	59 / 59
	Outdoor	Cooling/Heating	66 / 66	67 / 67	68 / 70	69 / 71
Sound pressure level*1	Indoor*3	Cooling (P-Hi/Hi/Me/Lo)	44 / 40 / 35 / 27	44 / 40 / 35 / 27	46 / 42 / 38 / 31	44 / 40 / 35 / 27
		Heating (P-Hi/Hi/Me/Lo)	44 / 40 / 35 / 27	44 / 40 / 35 / 27	46 / 42 / 38 / 31	44 / 40 / 35 / 27
	Outdoor	Cooling/Heating	51 / 51	53 / 51	53 / 54	54 / 54
		Cooling (P-Hi/Hi/Me/Lo)	13 / 11 / 9 / 7	13 / 11 / 9 / 7	14 / 12 / 10 / 8	13 / 11 / 9 / 7
Air flow	Indoor*3	Heating (P-Hi/Hi/Me/Lo)	13 / 11 / 9 / 7	13 / 11 / 9 / 7	14 / 12 / 10 / 8	13 / 11 / 9 / 7
		Cooling/Heating	60 / 50	100 / 100	100 / 100	100 / 100
	Outdoor	Cooling/Heating	60 / 50	100 / 100	100 / 100	100 / 100
Exterior dimensions	Indoor	HeightxWidthxDepth	Unit: 248 x 570 x 570 Panel: 10 x 620 x 620			
	Outdoor	HeightxWidthxDepth	750 x 880(+88) x 340	1,300 x 970 x 370		
Net weight	Indoor		16.5(Unit:14 Standard Panel:2.5)			
	Outdoor		60	97		
Ref.piping size	Liquid/Gas	ømm	9.52(3/8") / 15.88(5/8")			
Refrigerant line (one way) length			Max.50	Max.100		
Vertical height differences			Max.30 / Max.15	Max.50 / Max.15		
Outdoor operating temperature range			Max.20 / Max.20			
Cooling			-15~50*2			
Heating			-20~20			
Panel			TC-PSA-5AW-E, TC-PSAE-5AW-E(Honeycomb) / TC-PSAG-5AW-E, TC-PSAGE-5AW-E(Grid)			
Air filter, Q'ty			Pocket plastic net x 1(Washable)			
Remote control (option)			wired:RC-EX3A, RC-E5, RCH-E3 wireless:RCN-TC-5AW-E3			

**NOTES:**

The data are measured under the following conditions(ISO-T1, -H1).  
 Cooling:Indoor temp. of 27°CDB, 19°CWB, and outdoor temp. of 35°CDB. Heating:Indoor temp. of 20°CDB, and outdoor temp. of 7°CDB, 6°CWB.  
 \*1 : Indicates the value in an anechoic chamber. During operation these values are somewhat higher due to ambient conditions.  
 \*2 : If a cooling operation is conducted when the outdoor air temperature is -5°C or lower, the outdoor unit should be installed at a place where it is not influenced by natural wind. If wind blows, the low pressure will drop and compressor frequency will increase, this will cause the capacity to drop and may cause the unit to break down.  
 \*3 : The values are for one indoor unit operation. (Multi system only)

## SPECIFICATIONS -FDTC-

The values are for simultaneous Multi operation.

R32			Hyper Inverter		
Set model name			FDTC100VSXWVPVH	FDTC125VSXWVPVH	FDTC140VSXWTVH
			Twin		Triple
Indoor unit			FDTC50VH x 2	FDTC60VH x 2	FDTC50VH x 3
Outdoor unit			FDC100VSX-W	FDC125VSX-W	FDC140VSX-W
Power source			3 Phase 380-415V, 50Hz / 380V, 60Hz		
Nominal cooling capacity (Min~Max)	kW		10.0 ( 3.5 ~ 11.2 )	12.5 ( 3.5 ~ 14.0 )	14.0 ( 3.5 ~ 16.0 )
Nominal heating capacity (Min~Max)	kW		11.2 ( 2.7 ~ 16.0 )	14.0 ( 2.7 ~ 18.0 )	16.0 ( 2.7 ~ 20.0 )
Power consumption	Cooling/Heating	kW	2.60 / 3.04	3.67 / 4.05	3.96 / 4.34
EER/COP	Cooling/Heating		3.84 / 3.69	3.41 / 3.45	3.54 / 3.69
Inrush current		A	5	5	5
Max. current			14	14	14
Sound power level*1	Indoor	Cooling/Heating	59 / 59	60 / 60	59 / 59
	Outdoor	Cooling/Heating	67 / 67	68 / 70	69 / 71
Sound pressure level*1	Indoor	Cooling (P-Hi/Hi/Me/Lo)	44 / 40 / 35 / 27	46 / 42 / 38 / 31	44 / 40 / 35 / 27
	Outdoor	Heating (P-Hi/Hi/Me/Lo)	44 / 40 / 35 / 27	46 / 42 / 38 / 31	44 / 40 / 35 / 27
Air flow	Indoor	Cooling/Heating	53 / 51	53 / 54	54 / 54
	Outdoor	Cooling/Heating	13 / 11 / 9 / 7	14 / 12 / 10 / 8	13 / 11 / 9 / 7
Exterior dimensions	Indoor	HeightxWidthxDepth	Unit: 248 x 570 x 570 Panel: 10 x 620 x 620		
	Outdoor		1,300 x 970 x 370		
Net weight	Indoor		16.5(Unit:14 Standard Panel:2.5)		
	Outdoor		99		
Ref.piping size	Liquid/Gas	ømm	9.52(3/8") / 15.88(5/8")		
Refrigerant line (one way) length		m	Max.100		
Vertical height differences	Outdoor is higher/lower	m	Max.50 / Max.15		
Outdoor operating temperature range	Cooling	°CDB	-15~50*2		
	Heating	°CWB	-20~20		
Panel			TC-PSA-5AW-E, TC-PSAE-5AW-E(Honeycomb) / TC-PSAG-5AW-E, TC-PSAGE-5AW-E(Grid)		
Air filter, Q'ty			Pocket plastic net x 1(Washable)		
Remote control (option)			wired:RC-EX3A, RC-E5, RCH-E3 wireless:RCN-TC-5AW-E3		

R410A			Hyper Inverter		
Set model name			FDTC40ZSXVH	FDTC50ZSXVH	FDTC60ZSXVH
Indoor unit			FDTC40VH	FDTC50VH	FDTC60VH
Outdoor unit			SRC40ZSX-S	SRC50ZSX-S	SRC60ZSX-S
Power source			1 Phase 220-240V, 50Hz / 220V, 60Hz		
Nominal cooling capacity (Min~Max)	kW		4.0 ( 1.1 ~ 4.7 )	5.0 ( 1.1 ~ 5.6 )	5.6 ( 1.1 ~ 6.3 )
Nominal heating capacity (Min~Max)	kW		4.5 ( 0.6 ~ 5.4 )	5.4 ( 0.6 ~ 6.3 )	6.7 ( 0.6 ~ 6.7 )
Power consumption	Cooling/Heating	kW	0.98 / 1.13	1.43 / 1.53	1.76 / 2.14
EER/COP	Cooling/Heating		4.08 / 3.98	3.50 / 3.53	3.18 / 3.13
Inrush current		A	5	5	5
Max. current			12	15	15
Sound power level*1	Indoor	Cooling/Heating	59 / 59	59 / 59	60 / 60
	Outdoor	Cooling/Heating	63 / 63	63 / 63	65 / 64
Sound pressure level*1	Indoor	Cooling (P-Hi/Hi/Me/Lo)	44 / 40 / 35 / 27	44 / 40 / 35 / 27	46 / 42 / 38 / 31
	Outdoor	Heating (P-Hi/Hi/Me/Lo)	44 / 40 / 35 / 27	44 / 40 / 35 / 27	46 / 42 / 38 / 31
Air flow	Indoor	Cooling/Heating	50 / 49	50 / 49	52 / 52
	Outdoor	Cooling/Heating	13 / 11 / 9 / 7	13 / 11 / 9 / 7	14 / 12 / 10 / 8
Exterior dimensions	Indoor	HeightxWidthxDepth	Unit: 248 x 570 x 570 Panel: 10 x 620 x 620		
	Outdoor		640 x 800(+71) x 290		
Net weight	Indoor		16.5(Unit:14 Standard Panel:2.5)		
	Outdoor		45		
Ref.piping size	Liquid/Gas	ømm	6.35(1/4") / 12.7(1/2")		
Refrigerant line (one way) length		m	Max.30		
Vertical height differences	Outdoor is higher/lower	m	Max.20 / Max.20		
Outdoor operating temperature range	Cooling	°CDB	-15~46*2		
	Heating	°CWB	-20~20		
Panel			TC-PSA-5AW-E, TC-PSAE-5AW-E(Honeycomb) / TC-PSAG-5AW-E, TC-PSAGE-5AW-E(Grid)		
Air filter, Q'ty			Pocket plastic net x 1(Washable)		
Remote control (option)			wired:RC-EX3A, RC-E5, RCH-E3 wireless:RCN-TC-5AW-E3		

### NOTES:

The data are measured under the following conditions(R32 : ISO-T1, -H1 / R410A : ISO-T1 ).

Cooling:Indoor temp. of 27°CDB, 19°CWB, and outdoor temp. of 35°CDB. Heating:Indoor temp. of 20°CDB, and outdoor temp. of 7°CDB, 6°CWB.

\*1 : Indicates the value in an anechoic chamber. During operation these values are somewhat higher due to ambient conditions.

\*2 : If a cooling operation is conducted when the outdoor air temperature is -5°C or lower, the outdoor unit should be installed at a place where it is not influenced by natural wind. If wind blows, the low pressure will drop and compressor frequency will increase, this will cause the capacity to drop and may cause the unit to break down.

\*3 : The values are for one indoor unit operation. (Multi system only)

The values are for simultaneous Multi operation.

R410A		Hyper Inverter			
Set model name		FDTC71VNXPVH	FDTC100VNXPVH	FDTC125VNXPVH	FDTC140VNXTVH
		Twin		Triple	
Indoor unit		FDTC40VH x 2	FDTC50VH x 2	FDTC60VH x 2	FDTC50VH x 3
Outdoor unit		FDC71VNX	FDC100VNX	FDC125VNX	FDC140VNX
Power source		1 Phase 220-240V, 50Hz / 220V, 60Hz			
Nominal cooling capacity (Min~Max)	kW	7.1 (3.2 ~ 8.0)	10.0 (4.0 ~ 11.2)	12.5 (5.0 ~ 14.0)	14.0 (5.0 ~ 16.0)
Nominal heating capacity (Min~Max)	kW	8.0 (3.6 ~ 9.0)	11.2 (4.0 ~ 12.5)	14.0 (4.0 ~ 17.0)	16.0 (4.0 ~ 18.0)
Power consumption	Cooling/Heating	2.03 / 1.64	2.80 / 3.50	4.10 / 4.10	4.20 / 4.34
EER/COP	Cooling/Heating	3.50 / 4.88	3.57 / 3.20	3.05 / 3.41	3.33 / 3.69
Inrush current		5	5	5	5
Max. current		17	24	24	26
Sound power level*1	Indoor*3	Cooling/Heating	59 / 59	60 / 60	59 / 59
	Outdoor	Cooling/Heating	66 / 66	70 / 70	72 / 72
Sound pressure level*1	Indoor*3	Cooling (P-Hi/Hi/Me/Lo)	44 / 40 / 35 / 27	44 / 40 / 35 / 27	44 / 40 / 35 / 27
		Heating (P-Hi/Hi/Me/Lo)	44 / 40 / 35 / 27	44 / 40 / 35 / 27	44 / 40 / 35 / 27
	Outdoor	Cooling/Heating	51 / 48	48 / 50	49 / 52
Air flow	Indoor*3	Cooling (P-Hi/Hi/Me/Lo)	13 / 11 / 9 / 7	13 / 11 / 9 / 7	13 / 11 / 9 / 7
		Heating (P-Hi/Hi/Me/Lo)	13 / 11 / 9 / 7	13 / 11 / 9 / 7	13 / 11 / 9 / 7
	Outdoor	Cooling/Heating	60 / 50	100 / 100	100 / 100
Exterior dimensions	Indoor	HeightxWidthxDepth	Unit: 248 x 570 x 570 Panel: 10 x 620 x 620		
	Outdoor		1,300 x 970 x 370		
Net weight	Indoor		16.5(Unit:14 Standard Panel:2.5)		
	Outdoor		105		
Ref.piping size	Liquid/Gas	ømm	9.52(3/8") / 15.88(5/8")		
Refrigerant line (one way) length		m	Max.50	Max.100	
Vertical height differences	Outdoor is higher/lower	m	Max.30 / Max.15		
Outdoor operating temperature range	Cooling	°CDB	-15~43*2		
	Heating	°CWB	-20~20		
Panel			TC-PSA-5AW-E, TC-PSAE-5AW-E(Honeycomb) / TC-PSAG-5AW-E, TC-PSAGE-5AW-E(Grid)		
Air filter, Q'ty			Pocket plastic net x 1(Washable)		
Remote control (option)			wired:RC-EX3A, RC-E5, RCH-E3 wireless:RCN-TC-5AW-E3		

The values are for simultaneous Multi operation.

R410A		Hyper Inverter		
Set model name		FDTC100VSXPVH	FDTC125VSXPVH	FDTC140VSXTVH
		Twin		Triple
Indoor unit		FDTC50VH x 2	FDTC60VH x 2	FDTC50VH x 3
Outdoor unit		FDC100VSX	FDC125VSX	FDC140VSX
Power source		3 Phase 380-415V, 50Hz / 380V, 60Hz		
Nominal cooling capacity (Min~Max)	kW	10.0 (4.0 ~ 11.2)	12.5 (5.0 ~ 14.0)	14.0 (5.0 ~ 16.0)
Nominal heating capacity (Min~Max)	kW	11.2 (4.0 ~ 16.0)	14.0 (4.0 ~ 18.0)	16.0 (4.0 ~ 20.0)
Power consumption	Cooling/Heating	2.80 / 3.50	4.10 / 4.10	4.20 / 4.34
EER/COP	Cooling/Heating	3.57 / 3.20	3.05 / 3.41	3.33 / 3.69
Inrush current		5	5	5
Max. current		15	15	15
Sound power level*1	Indoor*3	Cooling/Heating	59 / 59	60 / 60
	Outdoor	Cooling/Heating	70 / 70	70 / 70
Sound pressure level*1	Indoor*3	Cooling (P-Hi/Hi/Me/Lo)	44 / 40 / 35 / 27	46 / 42 / 38 / 31
		Heating (P-Hi/Hi/Me/Lo)	44 / 40 / 35 / 27	46 / 42 / 38 / 31
	Outdoor	Cooling/Heating	48 / 50	48 / 50
Air flow	Indoor*3	Cooling (P-Hi/Hi/Me/Lo)	13 / 11 / 9 / 7	14 / 12 / 10 / 8
		Heating (P-Hi/Hi/Me/Lo)	13 / 11 / 9 / 7	14 / 12 / 10 / 8
	Outdoor	Cooling/Heating	100 / 100	100 / 100
Exterior dimensions	Indoor	HeightxWidthxDepth	Unit: 248 x 570 x 570 Panel: 10 x 620 x 620	
	Outdoor		1,300 x 970 x 370	
Net weight	Indoor		16.5(Unit:14 Standard Panel:2.5)	
	Outdoor		105	
Ref.piping size	Liquid/Gas	ømm	9.52(3/8") / 15.88(5/8")	
Refrigerant line (one way) length		m	Max.100	
Vertical height differences	Outdoor is higher/lower	m	Max.30 / Max.15	
Outdoor operating temperature range	Cooling	°CDB	-15~43*2	
	Heating	°CWB	-20~20	
Panel			TC-PSA-5AW-E, TC-PSAE-5AW-E(Honeycomb) / TC-PSAG-5AW-E, TC-PSAGE-5AW-E(Grid)	
Air filter, Q'ty			Pocket plastic net x 1(Washable)	
Remote control (option)			wired:RC-EX3A, RC-E5, RCH-E3 wireless:RCN-TC-5AW-E3	

# SPECIFICATIONS -FDTC-

The values are for simultaneous Multi operation.

R32		Micro Inverter		
Set model name		FDTC100VNAWPVH	FDTC125VNAWPVH	FDTC140VNAWTVH
		Twin		Triple
Indoor unit		FDTC50VH x 2	FDTC60VH x 2	FDTC50VH x 3
Outdoor unit		FDC100VNA-W	FDC125VNA-W	FDC140VNA-W
Power source		1 Phase 220-240V, 50Hz / 220V, 60Hz		
Nominal cooling capacity (Min-Max)	kW	10.0 ( 4.0 ~ 11.2 )	12.5 ( 5.0 ~ 14.0 )	13.6 ( 5.0 ~ 14.5 )
Nominal heating capacity (Min-Max)	kW	11.2 ( 4.0 ~ 12.5 )	14.0 ( 4.0 ~ 16.0 )	15.5 ( 4.0 ~ 16.5 )
Power consumption	Cooling/Heating kW	3.15 / 3.05	4.90 / 4.30	4.75 / 4.60
EER/COP	Cooling/Heating	3.17 / 3.67	2.55 / 3.26	2.86 / 3.37
Inrush current		5	5	5
Max. current	A	24	24	24
Sound power level*1	Indoor <sup>+3</sup>	Cooling/Heating	59 / 59	60 / 60
	Outdoor	Cooling/Heating	69 / 70	71 / 71
Sound pressure level*1	Indoor <sup>+3</sup>	Cooling (P-Hi/Hi/Me/Lo)	44 / 40 / 35 / 27	46 / 42 / 38 / 31
	Outdoor	Heating (P-Hi/Hi/Me/Lo)	44 / 40 / 35 / 27	46 / 42 / 38 / 31
Air flow	Indoor <sup>+3</sup>	Cooling/Heating	54 / 55	54 / 56
	Outdoor	Cooling (P-Hi/Hi/Me/Lo)	13 / 11 / 9 / 7	14 / 12 / 10 / 8
Exterior dimensions	Indoor	HeightxWidthxDepth	Unit: 248 x 570 x 570 Panel: 10 x 620 x 620	
	Outdoor		845 x 970 x 370	
Net weight	Indoor		16.5(Unit:14 Standard Panel:2.5)	
	Outdoor		77	
Ref.piping size	Liquid/Gas		9.52(3/8") / 15.88(5/8")	
Refrigerant line (one way) length			Max.50	
Vertical height differences	Outdoor is higher/lower		Max.50 / Max.15	
Outdoor operating temperature range	Cooling	°CDB	-15~50*2	
	Heating	°CWB	-20~20	
Panel			TC-PSA-5AW-E, TC-PSAE-5AW-E(Honeycomb) / TC-PSAG-5AW-E, TC-PSAGE-5AW-E(Grid)	
Air filter, Q'ty			Pocket plastic net x 1(Washable)	
Remote control (option)			wired:RC-EX3A, RC-E5, RCH-E3, wireless:RCN-TC-5AW-E3	

The values are for simultaneous Multi operation.

R32		Micro Inverter				
Set model name		FDTC100VSAWPVH	FDTC125VSAWPVH	FDTC140VSAWTVH	FDTC200VSAWDVH	FDTC250VSAWDVH
		Twin		Triple	Double Twin	
Indoor unit		FDTC50VH x 2	FDTC60VH x 2	FDTC50VH x 3	FDTC50VH x 4	FDTC60VH x 4
Outdoor unit		FDC100VSA-W	FDC125VSA-W	FDC140VSA-W	FDC200VSA-W	FDC250VSA-W
Power source		3 Phase 380-415V, 50Hz / 380V, 60Hz				
Nominal cooling capacity (Min-Max)	kW	10.0 ( 4.0 ~ 11.2 )	12.5 ( 5.0 ~ 14.0 )	13.6 ( 5.0 ~ 14.5 )	20.0 ( 7.1 ~ 22.4 )	25.0 ( 7.1 ~ 28.0 )
Nominal heating capacity (Min-Max)	kW	11.2 ( 4.0 ~ 12.5 )	14.0 ( 4.0 ~ 16.0 )	15.5 ( 4.0 ~ 16.5 )	22.4 ( 6.6 ~ 25.0 )	28.0 ( 5.2 ~ 31.5 )
Power consumption	Cooling/Heating kW	3.15 / 3.05	4.90 / 4.30	4.75 / 4.60	6.92 / 6.37	9.43 / 8.75
EER/COP	Cooling/Heating	3.17 / 3.67	2.55 / 3.26	2.86 / 3.37	2.89 / 3.52	2.65 / 3.20
Inrush current		5	5	5	5	5
Max. current	A	15	15	15	19	20
Sound power level*1	Indoor <sup>+3</sup>	Cooling/Heating	59 / 59	60 / 60	59 / 59	60 / 60
	Outdoor	Cooling/Heating	69 / 70	71 / 71	72 / 73	72 / 74
Sound pressure level*1	Indoor <sup>+3</sup>	Cooling (P-Hi/Hi/Me/Lo)	44 / 40 / 35 / 27	46 / 42 / 38 / 31	44 / 40 / 35 / 27	44 / 40 / 35 / 27
	Outdoor	Heating (P-Hi/Hi/Me/Lo)	44 / 40 / 35 / 27	46 / 42 / 38 / 31	44 / 40 / 35 / 27	44 / 40 / 35 / 27
Air flow	Indoor <sup>+3</sup>	Cooling/Heating	54 / 55	54 / 56	56 / 58	58 / 59
	Outdoor	Cooling (P-Hi/Hi/Me/Lo)	13 / 11 / 9 / 7	14 / 12 / 10 / 8	13 / 11 / 9 / 7	13 / 11 / 9 / 7
Exterior dimensions	Indoor	HeightxWidthxDepth	Unit: 248 x 570 x 570 Panel: 10 x 620 x 620		1,505 x 970 x 370	
	Outdoor		845 x 970 x 370			
Net weight	Indoor		16.5(Unit:14 Standard Panel:2.5)			
	Outdoor		78	144	145	
Ref.piping size	Liquid/Gas		9.52(3/8") / 15.88(5/8")		9.52(3/8") / 22.22(7/8")	12.7(1/2") / 22.22(7/8")
Refrigerant line (one way) length			Max.50		Max.70	
Vertical height differences	Outdoor is higher/lower		Max.50 / Max.15		Max.50*4 / Max.15	
Outdoor operating temperature range	Cooling	°CDB	-15~50*2			
	Heating	°CWB	-20~20			
Panel			TC-PSA-5AW-E, TC-PSAE-5AW-E(Honeycomb) / TC-PSAG-5AW-E, TC-PSAGE-5AW-E(Grid)			
Air filter, Q'ty			Pocket plastic net x 1(Washable)			
Remote control (option)			wired:RC-EX3A, RC-E5, RCH-E3, wireless:RCN-TC-5AW-E3			

## NOTES:

- The data are measured under the following conditions(R32 : ISO-T1, -H1 / R410A : ISO-T1).  
 Cooling:Indoor temp. of 27°CDB, 19°CWB, and outdoor temp. of 35°CDB. Heating:Indoor temp. of 20°CDB, and outdoor temp. of 7°CDB, 6°CWB.  
 \*1 : Indicates the value in an anechoic chamber. During operation these values are somewhat higher due to ambient conditions.  
 \*2 : If a cooling operation is conducted when the outdoor air temperature is -5°C or lower, the outdoor unit should be installed at a place where it is not influenced by natural wind. If wind blows, the low pressure will drop and compressor frequency will increase, this will cause the capacity to drop and may cause the unit to break down.  
 \*3 : The values are for one indoor unit operation. (Multi system only)  
 \*4 : In case of following conditions:Max.50m(Outdoor unit is higher & Outdoor temperature ≤ 43°C), Max.30m(Outdoor unit is higher & Outdoor temperature > 43°C)



The values are for simultaneous Multi operation.

R410A			Micro Inverter		
Set model name			FDTC100VNAPVH	FDTC125VNAPVH	FDTC140VNATVH
			Twin		Triple
Indoor unit			FDTC50VH x 2	FDTC60VH x 2	FDTC50VH x 3
Outdoor unit			FDC100VNA	FDC125VNA	FDC140VNA
Power source			1 Phase 220-240V, 50Hz / 220V, 60Hz		
Nominal cooling capacity (Min~Max)	kW		10.0 ( 4.0 ~ 11.2 )	12.5 ( 5.0 ~ 14.0 )	13.6 ( 5.0 ~ 14.5 )
Nominal heating capacity (Min~Max)	kW		11.2 ( 4.0 ~ 12.5 )	14.0 ( 4.0 ~ 16.0 )	15.5 ( 4.0 ~ 16.5 )
Power consumption	Cooling/Heating	kW	3.30 / 3.15	4.90 / 4.50	4.75 / 4.60
EER/COP	Cooling/Heating		3.03 / 3.56	2.55 / 3.11	2.86 / 3.37
Inrush current		A	5	5	5
Max. current			25	25	25
Sound power level* <sup>1</sup>	Indoor <sup>3</sup>	Cooling/Heating	59 / 59	60 / 60	59 / 59
	Outdoor	Cooling/Heating	70 / 70	71 / 71	73 / 73
Sound pressure level* <sup>1</sup>	Indoor <sup>3</sup>	Cooling (P-Hi/Hi/Me/Lo)	44 / 40 / 35 / 27	46 / 42 / 38 / 31	44 / 40 / 35 / 27
		Heating (P-Hi/Hi/Me/Lo)	44 / 40 / 35 / 27	46 / 42 / 38 / 31	44 / 40 / 35 / 27
	Outdoor	Cooling/Heating	54 / 56	55 / 57	57 / 59
Air flow	Indoor <sup>3</sup>	Cooling (P-Hi/Hi/Me/Lo)	13 / 11 / 9 / 7	14 / 12 / 10 / 8	13 / 11 / 9 / 7
		Heating (P-Hi/Hi/Me/Lo)	13 / 11 / 9 / 7	14 / 12 / 10 / 8	13 / 11 / 9 / 7
	Outdoor	Cooling/Heating	75 / 73	75 / 73	75 / 73
Exterior dimensions	Indoor	HeightxWidthxDepth	Unit: 248 x 570 x 570 Panel: 10 x 620 x 620		
	Outdoor		845 x 970 x 370		
Net weight	Indoor		16.5(Unit:14 Standard Panel:2.5)		
	Outdoor		80		
Ref.piping size	Liquid/Gas	ømm	9.52(3/8") / 15.88(5/8")		
Refrigerant line (one way) length		m	Max.50		
Vertical height differences	Outdoor is higher/lower	m	Max.50 / Max.15		
Outdoor operating temperature range	Cooling	°CDB	-15~50* <sup>2</sup>		
	Heating	°CWB	-20~20		
Panel			TC-PSA-5AW-E, TC-PSAE-5AW-E(Honeycomb) / TC-PSAG-5AW-E, TC-PSAGE-5AW-E(Grid)		
Air filter, Q'ty			Pocket plastic net x 1(Washable)		
Remote control (option)			wired:RC-EX3A, RC-E5, RCH-E3, wireless:RCN-TC-5AW-E3		

The values are for simultaneous Multi operation.

R410A			Micro Inverter				
Set model name			FDTC100VSAPVH	FDTC125VSAPVH	FDTC140VSATVH	FDTC200VSADVH	FDTC250VSADVH
			Twin		Triple	Double Twin	
Indoor unit			FDTC50VH x 2	FDTC60VH x 2	FDTC50VH x 3	FDTC50VH x 4	FDTC60VH x 4
Outdoor unit			FDC100VSA	FDC125VSA	FDC140VSA	FDC200VSA	FDC250VSA
Power source			3 Phase 380-415V, 50Hz / 380V, 60Hz				
Nominal cooling capacity (Min~Max)	kW		10.0 ( 4.0 ~ 11.2 )	12.5 ( 5.0 ~ 14.0 )	13.6 ( 5.0 ~ 14.5 )	19.0 ( 5.2 ~ 22.4 )	24.0 ( 6.9 ~ 28.0 )
Nominal heating capacity (Min~Max)	kW		11.2 ( 4.0 ~ 12.5 )	14.0 ( 4.0 ~ 16.0 )	15.5 ( 4.0 ~ 16.5 )	22.4 ( 3.3 ~ 25.0 )	27.0 ( 5.5 ~ 31.5 )
Power consumption	Cooling/Heating	kW	3.30 / 3.15	4.90 / 4.50	4.75 / 4.60	6.95 / 6.79	10.65 / 8.20
EER/COP	Cooling/Heating		3.03 / 3.56	2.55 / 3.11	2.86 / 3.37	2.73 / 3.30	2.25 / 3.29
Inrush current		A	5	5	5	5	5
Max. current			15	15	15	20	21
Sound power level* <sup>1</sup>	Indoor <sup>3</sup>	Cooling/Heating	59 / 59	60 / 60	59 / 59	59 / 59	60 / 60
	Outdoor	Cooling/Heating	70 / 70	71 / 71	73 / 73	72 / 74	75 / 75
Sound pressure level* <sup>1</sup>	Indoor <sup>3</sup>	Cooling (P-Hi/Hi/Me/Lo)	44 / 40 / 35 / 27	46 / 42 / 38 / 31	44 / 40 / 35 / 27	44 / 40 / 35 / 27	46 / 42 / 38 / 31
		Heating (P-Hi/Hi/Me/Lo)	44 / 40 / 35 / 27	46 / 42 / 38 / 31	44 / 40 / 35 / 27	44 / 40 / 35 / 27	46 / 42 / 38 / 31
	Outdoor	Cooling/Heating	54 / 56	55 / 57	57 / 59	58 / 59	61 / 62
Air flow	Indoor <sup>3</sup>	Cooling (P-Hi/Hi/Me/Lo)	13 / 11 / 9 / 7	14 / 12 / 10 / 8	13 / 11 / 9 / 7	13 / 11 / 9 / 7	14 / 12 / 10 / 8
		Heating (P-Hi/Hi/Me/Lo)	13 / 11 / 9 / 7	14 / 12 / 10 / 8	13 / 11 / 9 / 7	13 / 11 / 9 / 7	14 / 12 / 10 / 8
	Outdoor	Cooling/Heating	75 / 73	75 / 73	75 / 73	135 / 135	143 / 151
Exterior dimensions	Indoor	HeightxWidthxDepth	Unit: 248 x 570 x 570 Panel: 10 x 620 x 620				
	Outdoor		845 x 970 x 370		1,300 x 970 x 370		1,505 x 970 x 370
Net weight	Indoor		16.5(Unit:14 Standard Panel:2.5)				
	Outdoor		82		115		143
Ref.piping size	Liquid/Gas	ømm	9.52(3/8") / 15.88(5/8")			9.52(3/8") / 22.22(7/8") / 12.7(1/2") / 22.22(7/8")	
Refrigerant line (one way) length		m	Max.50			Max.70	
Vertical height differences	Outdoor is higher/lower	m	Max.50 / Max.15			Max.30 / Max.15	
Outdoor operating temperature range	Cooling	°CDB	-15~50* <sup>2</sup>				
	Heating	°CWB	-20~20		-15~20		
Panel			TC-PSA-5AW-E, TC-PSAE-5AW-E(Honeycomb) / TC-PSAG-5AW-E, TC-PSAGE-5AW-E(Grid)				
Air filter, Q'ty			Pocket plastic net x 1(Washable)				
Remote control (option)			wired:RC-EX3A, RC-E5, RCH-E3 wireless:RCN-TC-5AW-E3				

# FDU

Indoor Unit

Duct Connected -High Static pressure-

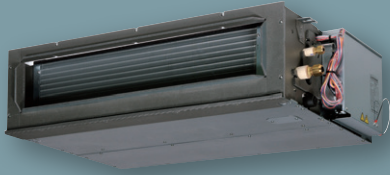

FDU 71/100/125/140

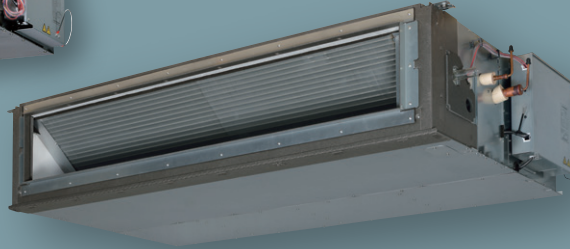

**New** FDU 200/250/280

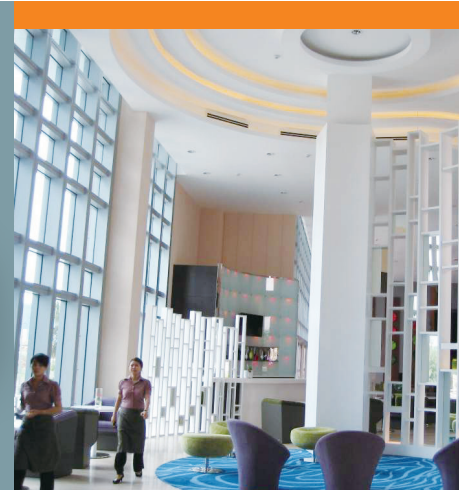

- Energy Saving
- Automatic Operation
- Silent Operation
- Hi Power
- Weekly/Sleep/Peak-Cut Timer
- Self-Diagnostics



Remote control (option)

Wired			Wireless	
RC-EX3A RC-EXZ3A	RC-E5	RCH-E3	RCN-KIT4-E2	

\*Not all functions available with all remote control options.

## External Static Pressure (E.S.P.) Control

The External Static Pressure (E.S.P.) can be manually set on the wired remote controller. Indoor unit will control the fan speed to keep rated air flow volume at each fan speed setting. You can set required E.S.P. by wired remote controller, calculated with the set air flow rate and the pressure loss of the duct.

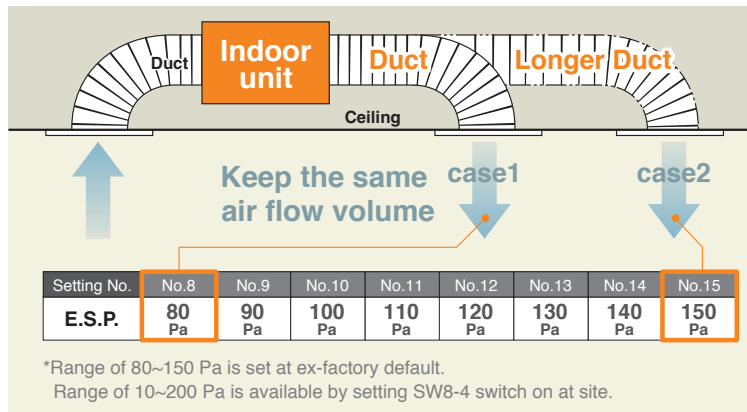

Expansion of external static pressure range

Previous  
10~130Pa



Current  
10~200Pa

### RC-E5

E.S.P. button

External Static Pressure (E.S.P.) can be set by E.S.P. button.



## Motion Sensor (Option)

**New**

Motion sensor is equipped in the ceiling plane or wall plane and detects the presence/absence and activity of humans in a room to improve the comfort and energy saving performance of the unit.



LB-KIT2

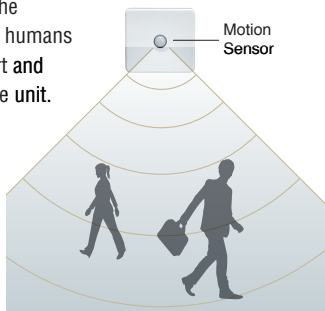

## High Efficiency

Energy efficiency is improved by use of DC fan motor & high efficient heat exchanger.

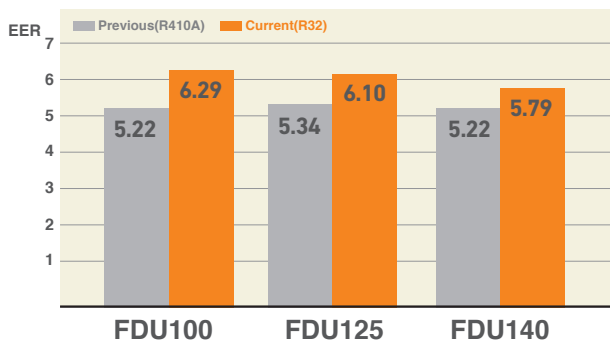

## Zoning system

Effectively control temperatures of multiple rooms with one indoor duct unit.

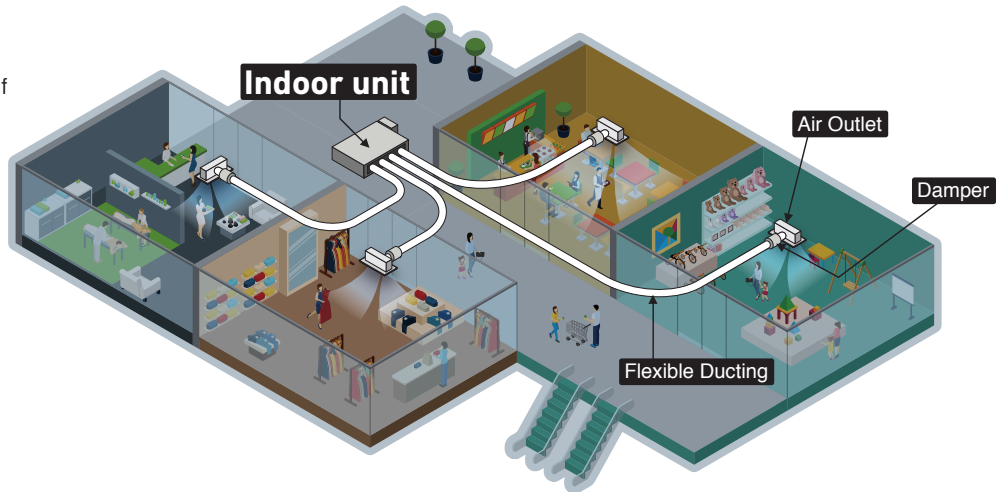

## Zone control function (Available for FDU71-140 and FDUM40-140)

These models have a zone control function that can control up to four zones. The zones consist of one (\*1) common zone and up to three (\*2) spill zones. The damper of each zone can be opened or closed with the exclusive remote control (RC-EXZ3A). Timer function to open/close the damper is also available.

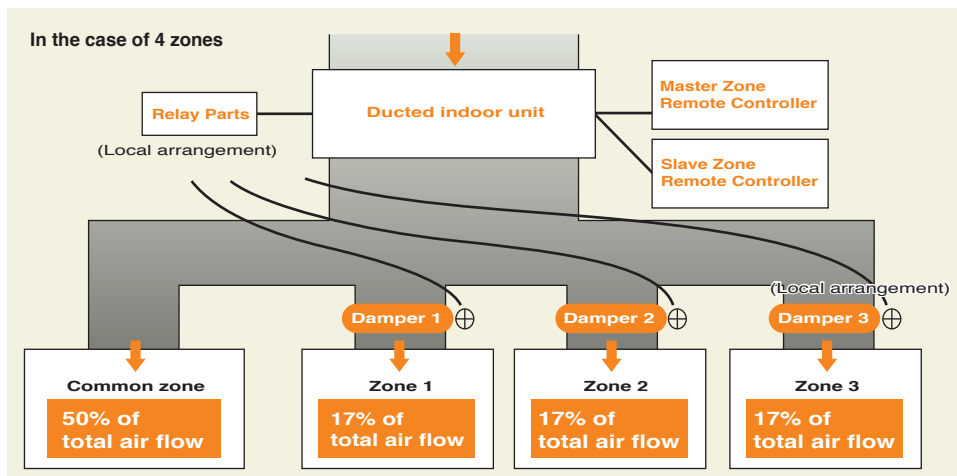

### RC-EXZ3A

Top display

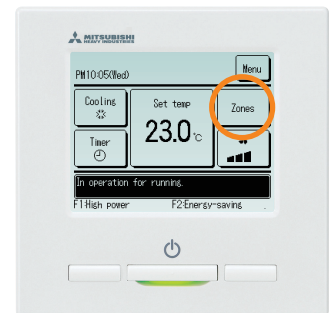

Zone menu

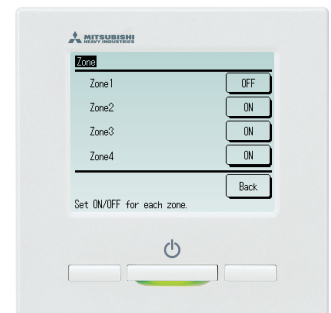

Notes:

- \*1: Common zone; A zone in which a damper is not installed.
- \*2: Spill zone; A zone in which a damper open automatically.
- Cannot control more than 4 zones.
- Procure relevant parts such as relay parts, dampers, ducts, and wirings locally.
- Design the duct so that each the common zone and the spill zones equal 50% of total air flow.
- Ducts in the spill zones should have equal static pressure.

## Round Duct Adapter (Available for FDU71~140 and FDUM40~140)

**AIRZONE** Company: AIRZONE  
URL: <http://www.airzone.es>

All-in-one solution: the whole zoning system in a plug&play device perfectly adapted to the indoor DX unit

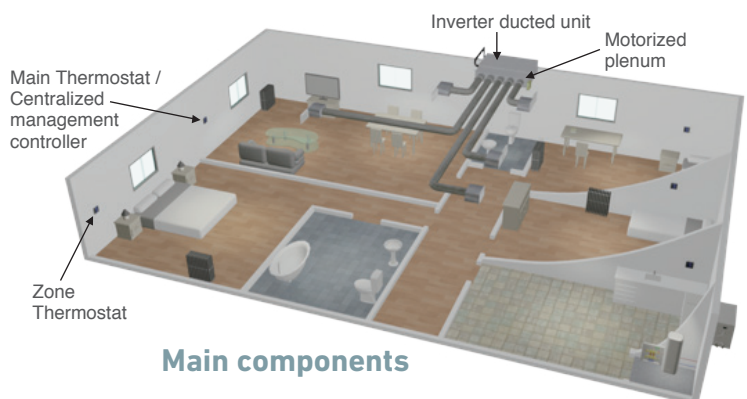
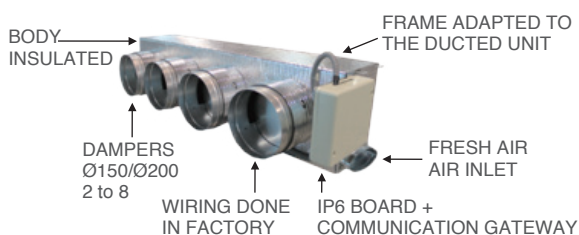

Main components

## Enhanced Installation Workability

600mm Drain Pump is mounted in FDU71/100/125/140.  
The indoor unit is completely hidden in the ceiling, so this is suitable for spaces with classy interior decoration.

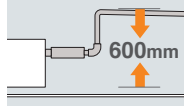

## Improvement of the Serviceability

Fan unit (impeller and motor) can be pulled out from the right side of the unit. Maintenance can be carried out from the right side or the bottom side of the unit.

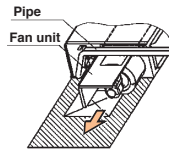

## Transparent Inspection Window

Dirt condition of the bottom of a drain pan can be checked through this transparent inspection window without removing drain pan.

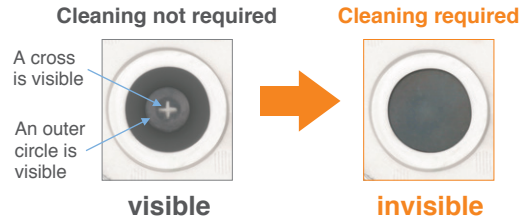

## OUTDOOR UNIT

		<b>Hyper Inverter</b>	
FDC		71VNX-W	100~140VN(S)X-W
		71VNX	100~140VN(S)X
model			
Chargeless		30m	
Height x Width x Depth (mm)		750 x 880(+88) x 340	1,300 x 970 x 370

		Micro Inverter			Standard Inverter		
FDC		100~140VN(S)A-W	—	200•250•280VSA-W	71VNP-W	90~100VNP-W	125VNP-W
		100~140VN(S)A	200VSA	250VSA	71VNP	90VNP1	100VNP
model							
Chargeless		30m			15m		
Height x Width x Depth (mm)		845 x 970 x 370	1,300 x 970 x 370	1,505 x 970 x 370	640 x 800(+71) x 290	750 x 880(+88) x 340	845 x 970 x 370

## DIMENSIONS (Unit:mm) - FDU -

### Model FDU71VH

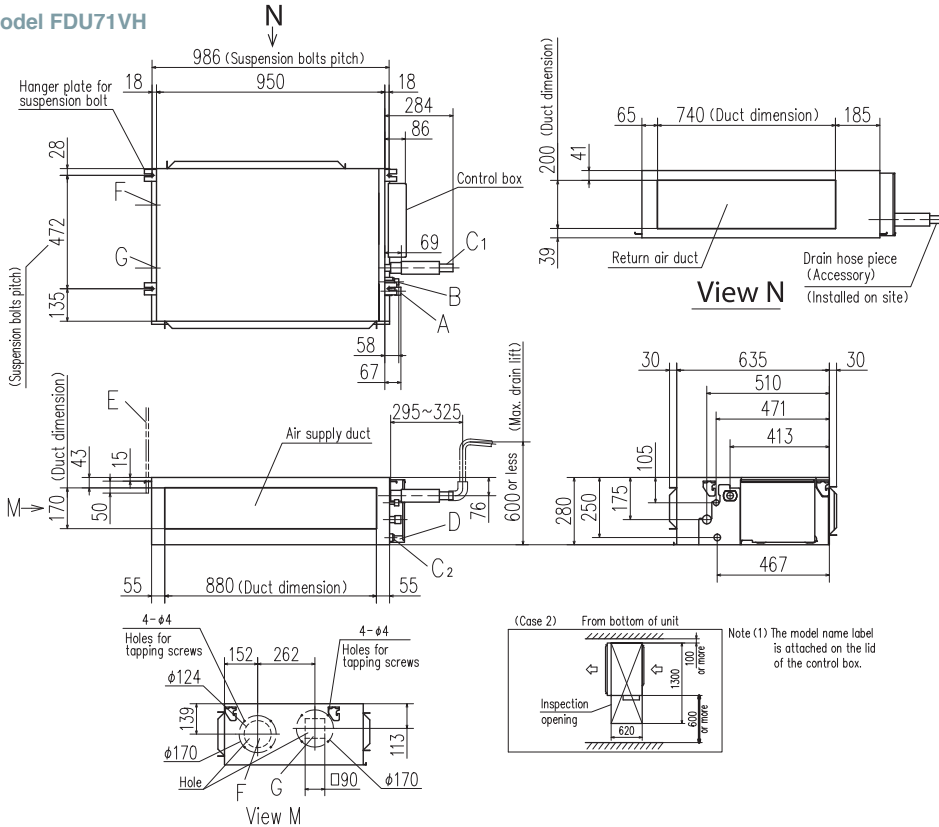

Symbol	Content
A	Gas piping $\phi 15.88 (5/8")$ (Flare)
B	Liquid piping $\phi 9.52 (3/8")$ (Flare)
C1	Drain piping VP25 (O.D.32)
C2	Drain piping (Gravity drainage) VP20
D	Hole for wiring
E	Suspension bolts M10
F	Outside air opening for ducting (Knock out)
G	Air outlet opening for ducting (Knock out)
H	Inspection opening (450X450)

Space for installation and service  
Select either of two cases to keep space for installation and services.  
(Case 1) From side of unit

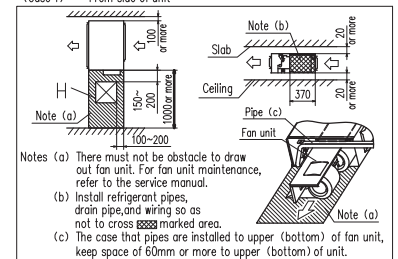

**Models FDU100VH, 125VH, 140VH**

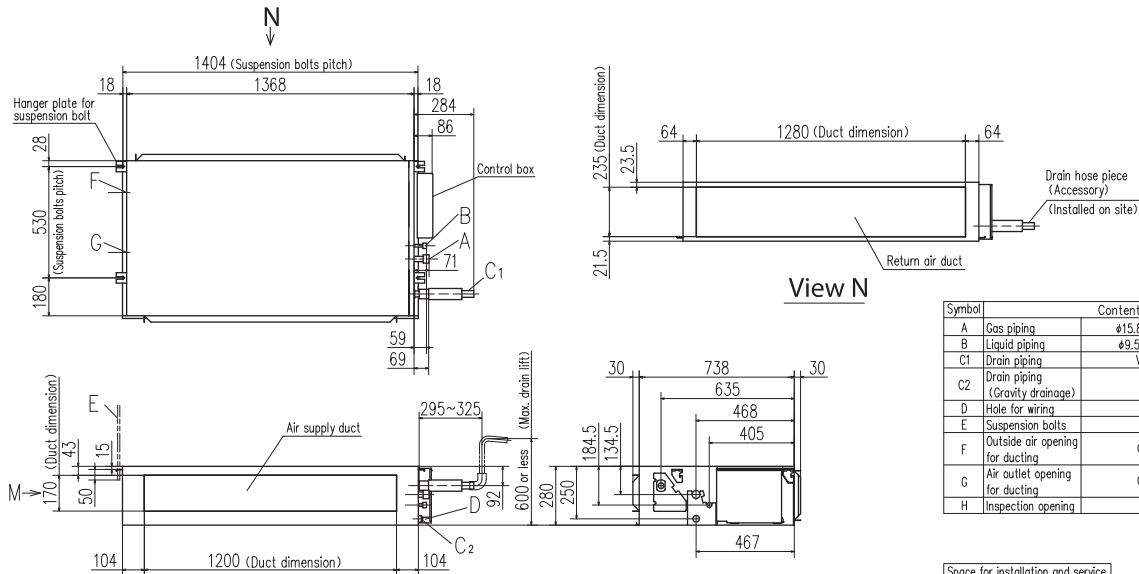

Symbol	Content
A	Gas piping $\phi 15.88$ (5/8") (Flare)
B	Liquid piping $\phi 9.52$ (3/8") (Flare)
C1	Drain piping VP25 (O.D.32)
C2	Drain piping (Gravity drainage) VP20
D	Hole for wiring M10
E	Suspension bolts (Knock out)
F	Outside air opening for ducting (450X450)
G	Air outlet opening for ducting (Knock out)
H	Inspection opening (450X450)

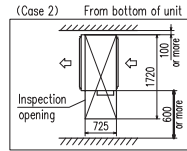
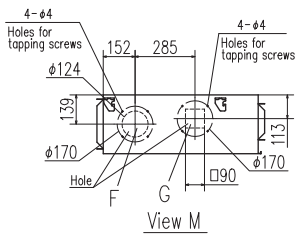

Note (1) The model name label is attached on the lid of the control box.

**Space for installation and service**

Select either of two cases to keep space for installation and services.  
(Case 1) From side of unit

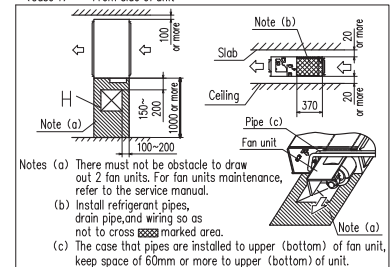

Notes (a) There must not be obstacle to draw out 2 fan units. For fan units maintenance, refer to the service manual.  
(b) Install refrigerant pipes, drain pipe, and wiring so as not to cross ~~XXXX~~ marked area.  
(c) The case that pipes are installed to upper (bottom) of fan unit, keep space of 60mm or more to upper (bottom) of unit.

**Models FDU200VH, 250VH, 280VH**

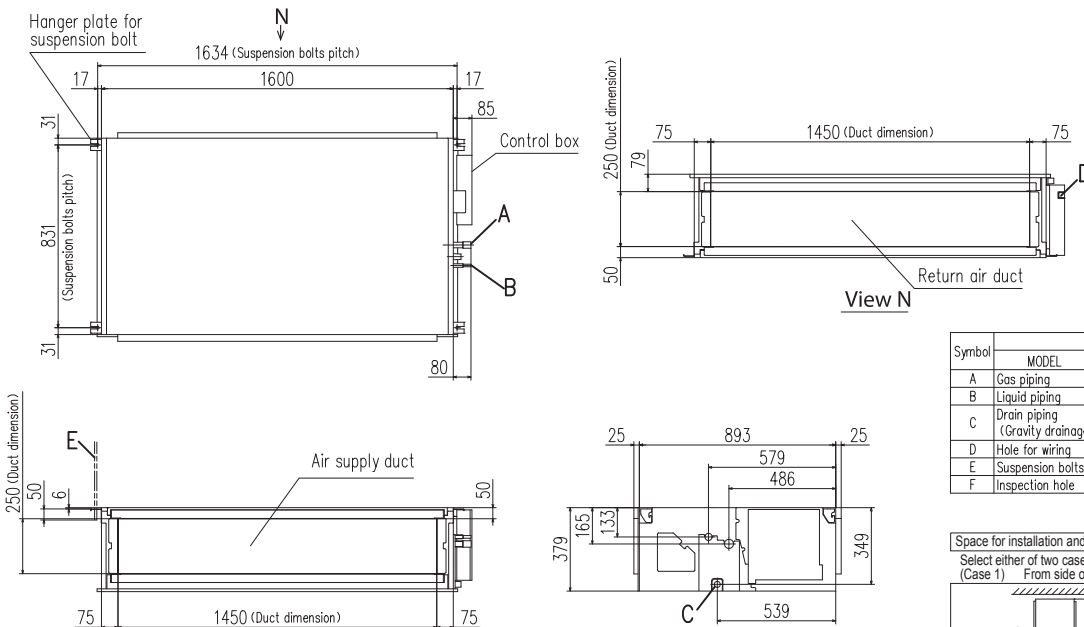

Symbol	Content	
	MODEL	200   250, 280
A	Gas piping $\phi 25.4$ (1") (Brazeing)	
B	Liquid piping $\phi 9.52$ (3/8") (Brazeing)   $\phi 12.7$ (1/2") (Brazeing)	
C	Drain piping (Gravity drainage) VP25 (O.D.32)	
D	Hole for wiring M10	
E	Suspension bolts (450X450)	
F	Inspection hole	

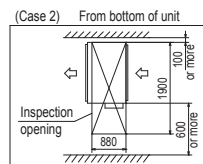

Note (1) The model name label is attached on the lid of the control box.

**Space for installation and service**

Select either of two cases to keep space for installation and services.  
(Case 1) From side of unit

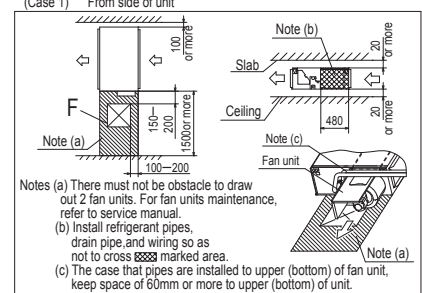

Notes (a) There must not be obstacle to draw out 2 fan units. For fan units maintenance, refer to service manual.  
(b) Install refrigerant pipes, drain pipe, and wiring so as not to cross ~~XXXX~~ marked area.  
(c) The case that pipes are installed to upper (bottom) of fan unit, keep space of 60mm or more to upper (bottom) of unit.

## SPECIFICATIONS -FDU-

R32			Hyper Inverter								
Set model name			FDU71VNXWVH	FDU100VNXWVH	FDU125VNXWVH	FDU140VNXWVH					
Indoor unit			FDU71VH	FDU100VH	FDU125VH	FDU140VH					
Outdoor unit			FDC71VNX-W	FDC100VNX-W	FDC125VNX-W	FDC140VNX-W					
Power source			1 Phase 220-240V, 50Hz / 220V, 60Hz								
Nominal cooling capacity (Min~Max)			kW		7.1 (3.2 ~ 8.0)	10.0 (3.5 ~ 11.2)	12.5 (3.5 ~ 14.0)	14.0 (3.5 ~ 16.0)			
Nominal heating capacity (Min~Max)			kW		8.0 (3.6 ~ 9.0)	11.2 (2.7 ~ 12.5)	14.0 (2.7 ~ 17.0)	16.0 (2.7 ~ 18.0)			
Power consumption			Cooling/Heating		kW		1.77 / 1.78	2.59 / 2.63	3.49 / 3.61	4.22 / 4.22	
EER/COP			Cooling/Heating				4.01 / 4.49	3.86 / 4.26	3.58 / 3.88	3.32 / 3.79	
Inrush current			A		5		5	5	5		
Max. current			A		20		26	28	30		
Sound power level*1			Indoor		Cooling/Heating		65 / 65		65 / 65	67 / 67	70 / 70
			Outdoor		Cooling/Heating		66 / 66		67 / 67	68 / 70	69 / 71
Sound pressure level*1			Indoor		Cooling (P-Hi/Hi/Me/Lo)		38 / 33 / 29 / 25		44 / 38 / 36 / 30	45 / 40 / 34 / 29	47 / 40 / 35 / 30
					Heating (P-Hi/Hi/Me/Lo)		38 / 33 / 29 / 25		44 / 38 / 36 / 30	45 / 40 / 34 / 29	47 / 40 / 35 / 30
			Outdoor		Cooling/Heating		51 / 51		53 / 51	53 / 54	54 / 54
Air flow			Indoor		Cooling (P-Hi/Hi/Me/Lo)		24 / 19 / 15 / 10		36 / 28 / 25 / 19	39 / 32 / 26 / 20	48 / 35 / 28 / 22
					Heating (P-Hi/Hi/Me/Lo)		24 / 19 / 15 / 10		36 / 28 / 25 / 19	39 / 32 / 26 / 20	48 / 35 / 28 / 22
			Outdoor		Cooling/Heating		60 / 50		100 / 100	100 / 100	100 / 100
External static pressure*2			Pa		Standard:35 Max:200		Standard:60 Max:200				
Exterior dimensions			Indoor		HeightxWidthxDepth		mm		280 x 950 x 635		
			Outdoor						280 x 1,370 x 740		
									750 x 880(+88) x 340		
Net weight			Indoor		kg		34		54		
			Outdoor				60		97		
Ref.piping size			Liquid/Gas		ømm		9.52(3/8") / 15.88(5/8")				
Refrigerant line (one way) length			m		Max.50		Max.100				
Vertical height differences			Outdoor is higher/lower		m		Max.30 / Max.15		Max.50 / Max.15		
Outdoor operating temperature range			Cooling		°CDB		-15~50*3				
			Heating		°CWB		-20~20				
Air filter			Procure locally								
Remote control (option)			wired:RC-EX3A, RC-E5, RCH-E3 wireless:RCN-KIT4-E2								

R32			Hyper Inverter								
Set model name			FDU100VSXWVH	FDU125VSXWVH	FDU140VSXWVH						
Indoor unit			FDU100VH	FDU125VH	FDU140VH						
Outdoor unit			FDC100VSX-W	FDC125VSX-W	FDC140VSX-W						
Power source			3 Phase 380-415V, 50Hz / 380V, 60Hz								
Nominal cooling capacity (Min~Max)			kW		10.0 (3.5 ~ 11.2)	12.5 (3.5 ~ 14.0)	14.0 (3.5 ~ 16.0)				
Nominal heating capacity (Min~Max)			kW		11.2 (2.7 ~ 16.0)	14.0 (2.7 ~ 18.0)	16.0 (2.7 ~ 20.0)				
Power consumption			Cooling/Heating		kW		2.59 / 2.63	3.49 / 3.61	4.22 / 4.22		
EER/COP			Cooling/Heating				3.86 / 4.26	3.58 / 3.88	3.32 / 3.79		
Inrush current			A		5		5	5			
Max. current			A		15		16	17			
Sound power level*1			Indoor		Cooling/Heating		65 / 65		67 / 67	70 / 70	
			Outdoor		Cooling/Heating		67 / 67		68 / 70	69 / 71	
Sound pressure level*1			Indoor		Cooling (P-Hi/Hi/Me/Lo)		44 / 38 / 36 / 30		45 / 40 / 34 / 29	47 / 40 / 35 / 30	
					Heating (P-Hi/Hi/Me/Lo)		44 / 38 / 36 / 30		45 / 40 / 34 / 29	47 / 40 / 35 / 30	
			Outdoor		Cooling/Heating		53 / 51		53 / 54	54 / 54	
Air flow			Indoor		Cooling (P-Hi/Hi/Me/Lo)		36 / 28 / 25 / 19		39 / 32 / 26 / 20	48 / 35 / 28 / 22	
					Heating (P-Hi/Hi/Me/Lo)		36 / 28 / 25 / 19		39 / 32 / 26 / 20	48 / 35 / 28 / 22	
			Outdoor		Cooling/Heating		100 / 100		100 / 100	100 / 100	
External static pressure*2			Pa		Standard:60 Max:200						
Exterior dimensions			Indoor		HeightxWidthxDepth		mm		280 x 1,370 x 740		
			Outdoor						1,300 x 970 x 370		
Net weight			Indoor		kg		54		99		
			Outdoor				99				
Ref.piping size			Liquid/Gas		ømm		9.52(3/8") / 15.88(5/8")				
Refrigerant line (one way) length			m		Max.100						
Vertical height differences			Outdoor is higher/lower		m		Max.50 / Max.15				
Outdoor operating temperature range			Cooling		°CDB		-15~50,*3				
			Heating		°CWB		-20~20				
Air filter			Procure locally								
Remote control (option)			wired:RC-EX3A, RC-E5, RCH-E3 wireless:RCN-KIT4-E2								

### NOTES:

The data are measured under the following conditions(R32:ISO-T1, -H1 / R410A:ISO-T1).

Cooling:Indoor temp. of 27°CDB, 19°CWB, and outdoor temp. of 35°CDB. Heating:Indoor temp. of 20°CDB, and outdoor temp. of 7°CDB, 6°CWB.

\*1 : Indicates the value in an anechoic chamber. During operation these values are somewhat higher due to ambient conditions.

\*2 : External static pressure is changeable to be set by the remote control. MAX external static pressure is "High static pressure" setting. The values of sound pressure level become 5dB(A) higher at external static pressure of 200Pa.

\*3 : If a cooling operation is conducted when the outdoor air temperature is -5°C or lower, the outdoor unit should be installed at a place where it is not influenced by natural wind. If wind blows, the low pressure will drop and compressor frequency will increase, this will cause the capacity to drop and may cause the unit to break down.

R410A			Hyper Inverter			
Set model name			FDU71VNXVH	FDU100VNXVH	FDU125VNXVH	FDU140VNXVH
Indoor unit			FDU71VH	FDU100VH	FDU125VH	FDU140VH
Outdoor unit			FDC71VNX	FDC100VNX	FDC125VNX	FDC140VNX
Power source			1 Phase 220-240V, 50Hz / 220V, 60Hz			
Nominal cooling capacity (Min~Max)			7.1 ( 3.2 ~ 8.0 )		10.0 ( 4.0 ~ 11.2 )	
Nominal heating capacity (Min~Max)			8.0 ( 3.6 ~ 9.0 )		14.0 ( 4.0 ~ 17.0 )	
Power consumption			2.05 / 2.01		3.49 / 3.77	
EER/COP			3.46 / 3.98		3.58 / 3.71	
Inrush current			5		5	
Max. current			17		29	
Sound power level*1	Indoor	Cooling/Heating	65 / 65		67 / 67	
	Outdoor	Cooling/Heating	66 / 66		70 / 70	
Sound pressure level*1	Indoor	Cooling (P-Hi/Hi/Me/Lo)	38 / 33 / 29 / 25		44 / 38 / 36 / 30	
		Heating (P-Hi/Hi/Me/Lo)	38 / 33 / 29 / 25		44 / 38 / 36 / 30	
	Outdoor	Cooling/Heating	51 / 48		48 / 50	
		Cooling/Heating	51 / 48		48 / 50	
Air flow	Indoor	Cooling (P-Hi/Hi/Me/Lo)	24 / 19 / 15 / 10		36 / 28 / 25 / 19	
		Heating (P-Hi/Hi/Me/Lo)	24 / 19 / 15 / 10		36 / 28 / 25 / 19	
	Outdoor	Cooling/Heating	60 / 50		100 / 100	
		Cooling/Heating	60 / 50		100 / 100	
External static pressure*2			Standard:35 Max:200		Standard:60 Max:200	
Exterior dimensions	Indoor	HeightxWidthxDepth	280 x 950 x 635		280 x 1,370 x 740	
	Outdoor	HeightxWidthxDepth	750 x 880(+88) x 340		1,300 x 970 x 370	
Net weight	Indoor		34		54	
	Outdoor		60		105	
Ref.piping size			Liquid/Gas		ømm	
Refrigerant line (one way) length			m		Max.50	
Vertical height differences			Outdoor is higher/lower		m	
Outdoor operating temperature range			Cooling		°CDB	
			Heating		°CWB	
Air filter			Procure locally			
Remote control (option)			wired:RC-EX3A, RC-E5, RCH-E3 wireless:RCN-KIT4-E2			

R410A			Hyper Inverter			
Set model name			FDU100VVSXVH	FDU125VVSXVH	FDU140VVSXVH	
Indoor unit			FDU100VH	FDU125VH	FDU140VH	
Outdoor unit			FDC100VSX	FDC125VSX	FDC140VSX	
Power source			3 Phase 380-415V, 50Hz / 380V, 60Hz			
Nominal cooling capacity (Min~Max)			10.0 ( 4.0 ~ 11.2 )		12.5 ( 5.0 ~ 14.0 )	
Nominal heating capacity (Min~Max)			11.2 ( 4.0 ~ 16.0 )		14.0 ( 4.0 ~ 18.0 )	
Power consumption			2.68 / 3.02		3.49 / 3.77	
EER/COP			3.73 / 3.71		3.58 / 3.71	
Inrush current			5		5	
Max. current			16		18	
Sound power level*1	Indoor	Cooling/Heating	65 / 65		67 / 67	
	Outdoor	Cooling/Heating	70 / 70		70 / 70	
Sound pressure level*1	Indoor	Cooling (P-Hi/Hi/Me/Lo)	44 / 38 / 36 / 30		45 / 40 / 34 / 29	
		Heating (P-Hi/Hi/Me/Lo)	44 / 38 / 36 / 30		45 / 40 / 34 / 29	
	Outdoor	Cooling/Heating	48 / 50		48 / 50	
		Cooling/Heating	48 / 50		48 / 50	
Air flow	Indoor	Cooling (P-Hi/Hi/Me/Lo)	36 / 28 / 25 / 19		39 / 32 / 26 / 20	
		Heating (P-Hi/Hi/Me/Lo)	36 / 28 / 25 / 19		39 / 32 / 26 / 20	
	Outdoor	Cooling/Heating	100 / 100		100 / 100	
		Cooling/Heating	100 / 100		100 / 100	
External static pressure*2			Pa			
Exterior dimensions			Indoor		HeightxWidthxDepth	
			Outdoor		mm	
Net weight			Indoor		kg	
			Outdoor		kg	
Ref.piping size			Liquid/Gas		ømm	
Refrigerant line (one way) length			m		Max.100	
Vertical height differences			Outdoor is higher/lower		m	
Outdoor operating temperature range			Cooling		°CDB	
			Heating		°CWB	
Air filter			Procure locally			
Remote control (option)			wired:RC-EX3A, RC-E5, RCH-E3 wireless:RCN-KIT4-E2			

## SPECIFICATIONS -FDU-

R32		Micro Inverter		
Set model name		FDU100VNAVWH	FDU125VNAVWH	FDU140VNAVWH
Indoor unit		FDU100VH	FDU125VH	FDU140VH
Outdoor unit		FDC100VNA-W	FDC125VNA-W	FDC140VNA-W
Power source		1 Phase 220-240V, 50Hz / 220V, 60Hz		
Nominal cooling capacity (Min~Max)	kW	10.0 ( 4.0 ~ 11.2 )	12.5 ( 5.0 ~ 14.0 )	13.6 ( 5.0 ~ 14.5 )
Nominal heating capacity (Min~Max)	kW	11.2 ( 4.0 ~ 12.5 )	14.0 ( 4.0 ~ 16.0 )	15.5 ( 4.0 ~ 16.5 )
Power consumption	Cooling/Heating	2.99 / 2.66	4.36 / 3.69	5.13 / 4.21
EER/COP	Cooling/Heating	3.35 / 4.21	2.87 / 3.79	2.65 / 3.68
Inrush current		5	5	5
Max. current		26	26	27
Sound power level*1	Indoor	Cooling/Heating	65 / 65	67 / 67
	Outdoor	Cooling/Heating	69 / 70	71 / 71
Sound pressure level*1	Indoor	Cooling (P-Hi/Hi/Me/Lo)	44 / 38 / 36 / 30	45 / 40 / 34 / 29
		Heating (P-Hi/Hi/Me/Lo)	44 / 38 / 36 / 30	45 / 40 / 34 / 29
Air flow	Indoor	Cooling (P-Hi/Hi/Me/Lo)	36 / 28 / 25 / 19	39 / 32 / 26 / 20
		Heating (P-Hi/Hi/Me/Lo)	36 / 28 / 25 / 19	39 / 32 / 26 / 20
	Outdoor	Cooling/Heating	75 / 73	75 / 73
External static pressure*2	Pa	Standard:60 Max:200		
Exterior dimensions	Indoor	HeightxWidthxDepth	280 x 1,370 x 740	
	Outdoor	HeightxWidthxDepth	845 x 970 x 370	
Net weight	Indoor		54	
	Outdoor		77	
Ref.piping size	Liquid/Gas	ømm	9.52(3/8") / 15.88(5/8")	
Refrigerant line (one way) length		m	Max.50	
Vertical height differences	Outdoor is higher/lower	m	Max.50 / Max.15	
Outdoor operating temperature range	Cooling	°CDB	-15~50*3	
	Heating	°CWB	-20~20	
Air filter			Procure locally	
Remote control (option)			wired:RC-EX3A, RC-E5, RCH-E3 wireless:RCN-KIT4-E2	

R32		Micro Inverter		
Set model name		FDU100VSAVWH	FDU125VSAVWH	FDU140VSAVWH
Indoor unit		FDU100VH	FDU125VH	FDU140VH
Outdoor unit		FDC100VSA-W	FDC125VSA-W	FDC140VSA-W
Power source		3 Phase 380-415V, 50Hz / 380V, 60Hz		
Nominal cooling capacity (Min~Max)	kW	10.0 ( 4.0 ~ 11.2 )	12.5 ( 5.0 ~ 14.0 )	13.6 ( 5.0 ~ 14.5 )
Nominal heating capacity (Min~Max)	kW	11.2 ( 4.0 ~ 12.5 )	14.0 ( 4.0 ~ 16.0 )	15.5 ( 4.0 ~ 16.5 )
Power consumption	Cooling/Heating	2.99 / 2.66	4.36 / 3.69	5.13 / 4.21
EER/COP	Cooling/Heating	3.35 / 4.21	2.87 / 3.79	2.65 / 3.68
Inrush current		5	5	5
Max. current		17	17	18
Sound power level*1	Indoor	Cooling/Heating	65 / 65	67 / 67
	Outdoor	Cooling/Heating	69 / 70	71 / 71
Sound pressure level*1	Indoor	Cooling (P-Hi/Hi/Me/Lo)	44 / 38 / 36 / 30	45 / 40 / 34 / 29
		Heating (P-Hi/Hi/Me/Lo)	44 / 38 / 36 / 30	45 / 40 / 34 / 29
Air flow	Indoor	Cooling (P-Hi/Hi/Me/Lo)	36 / 28 / 25 / 19	39 / 32 / 26 / 20
		Heating (P-Hi/Hi/Me/Lo)	36 / 28 / 25 / 19	39 / 32 / 26 / 20
	Outdoor	Cooling/Heating	75 / 73	75 / 73
External static pressure*2	Pa	Standard:60 Max:200		
Exterior dimensions	Indoor	HeightxWidthxDepth	280 x 1,370 x 740	
	Outdoor	HeightxWidthxDepth	845 x 970 x 370	
Net weight	Indoor		54	
	Outdoor		78	
Ref.piping size	Liquid/Gas	ømm	9.52(3/8") / 15.88(5/8")	
Refrigerant line (one way) length		m	Max.50	
Vertical height differences	Outdoor is higher/lower	m	Max.50 / Max.15	
Outdoor operating temperature range	Cooling	°CDB	-15~50*3	
	Heating	°CWB	-20~20	
Air filter			Procure locally	
Remote control (option)			wired:RC-EX3A, RC-E5, RCH-E3 wireless:RCN-KIT4-E2	

### NOTES:

The data are measured under the following conditions(R32 : ISO-T1, -H1 / R410A : ISO-T1).

Cooling:Indoor temp. of 27°CDB, 19°CWB, and outdoor temp. of 35°CDB. Heating:Indoor temp. of 20°CDB, and outdoor temp. of 7°CDB, 6°CWB.

\*1 : Indicates the value in an anechoic chamber. During operation these values are somewhat higher due to ambient conditions.

\*2 : External static pressure is changeable to be set by the remote control. MAX external static pressure is "High static pressure" setting. The values of sound pressure level become 5dB(A) higher at external static pressure of 200Pa.

\*3 : If a cooling operation is conducted when the outdoor air temperature is -5°C or lower, the outdoor unit should be installed at a place where it is not influenced by natural wind. If wind blows, the low pressure will drop and compressor frequency will increase, this will cause the capacity to drop and may cause the unit to break down.

\*4 : In case of following conditions:Max.50m(Outdoor unit is higher & Outdoor temperature 43°C), Max.30m(Outdoor unit is higher & Outdoor temperature > 43°C)



R32			Micro Inverter		
Set model name			FDU200VSAWVH	FDU250VSAWVH	FDU280VSAWVH
Indoor unit			FDU200VH	FDU250VH	FDU280VH
Outdoor unit			FDC200VSA-W	FDC250VSA-W	FDC280VSA-W
Power source			3 Phase 380-415V, 50Hz / 380V, 60Hz		
Nominal cooling capacity (Min~Max)			20.0 ( 7.2 ~ 22.4 )	25.0 ( 7.2 ~ 28.0 )	27.0 ( 6.9 ~ 31.5 )
Nominal heating capacity (Min~Max)			22.4 (6.5 ~ 25.0)	28.0 (6.7 ~ 31.5)	30.0 (6.9 ~ 33.5)
Power consumption		Cooling/Heating	6.15 / 5.67	8.25 / 7.55	9.15 / 9.12
EER/COP		Cooling/Heating	3.25 / 3.95	3.03 / 3.75	2.95 / 3.29
Inrush current		A	5	5	5
Max. current			23	25	25
Sound power level*1	Indoor	Cooling/Heating	78 / 78	78 / 78	78 / 78
	Outdoor	Cooling/Heating	72 / 74	73 / 75	75 / 77
Sound pressure level*1	Indoor	Cooling (P-Hi/Hi/Me/Lo)	52 / 50 / 47 / 45	52 / 50 / 47 / 45	52 / 50 / 47 / 45
		Heating (P-Hi/Hi/Me/Lo)			
	Outdoor	Cooling/Heating	58 / 59	58 / 62	61 / 63
		Cooling (P-Hi/Hi/Me/Lo)	80 / 72 / 64 / 56	80 / 72 / 64 / 56	80 / 72 / 64 / 56
Air flow	Indoor	Heating (P-Hi/Hi/Me/Lo)	80 / 72 / 64 / 56	80 / 72 / 64 / 56	80 / 72 / 64 / 56
		Cooling/Heating	148 / 134	148 / 153	136 / 140
External static pressure*2		Pa	Standard:72 Max:200		
Exterior dimensions	Indoor	HeightxWidthxDepth	mm	379 x 1,600 x 893	
	Outdoor			1,505 x 970 x 370	
Net weight	Indoor		kg	88	
	Outdoor			144	145
Ref.piping size	Liquid/Gas	ømm	9.52(3/8") / 22.22(7/8")		
Refrigerant line (one way) length			Max.70		Max.60
Vertical height differences			Outdoor is higher/lower		
Outdoor operating temperature range			Max.50*4 / Max.15		
Cooling			-15~50*3		
Heating			-20~20		
Air filter			Procure locally		
Remote control (option)			wired:RC-EX3A, RC-E5, RCH-E3 wireless:RCN-KIT4-E2		

R410A			Micro Inverter		
Set model name			FDU100VNAVH	FDU125VNAVH	FDU140VNAVH
Indoor unit			FDU100VH	FDU125VH	FDU140VH
Outdoor unit			FDC100VNA	FDC125VNA	FDC140VNA
Power source			1 Phase 220-240V, 50Hz / 220V, 60Hz		
Nominal cooling capacity (Min~Max)			10.0 ( 4.0 ~ 11.2 )	12.5 ( 5.0 ~ 14.0 )	13.6 ( 5.0 ~ 14.5 )
Nominal heating capacity (Min~Max)			11.2 (4.0 ~ 12.5)	14.0 (4.0 ~ 16.0)	15.5 (4.0 ~ 16.5)
Power consumption		Cooling/Heating	2.84 / 2.78	4.36 / 3.69	4.93 / 4.21
EER/COP		Cooling/Heating	3.52 / 4.03	2.87 / 3.79	2.76 / 3.68
Inrush current		A	5	5	5
Max. current			26	26	27
Sound power level*1	Indoor	Cooling/Heating	65 / 65	67 / 67	70 / 70
	Outdoor	Cooling/Heating	70 / 70	71 / 71	73 / 73
Sound pressure level*1	Indoor	Cooling (P-Hi/Hi/Me/Lo)	44 / 38 / 36 / 30	45 / 40 / 34 / 29	47 / 40 / 35 / 30
		Heating (P-Hi/Hi/Me/Lo)			
	Outdoor	Cooling/Heating	54 / 56	55 / 57	57 / 59
		Cooling (P-Hi/Hi/Me/Lo)	36 / 28 / 25 / 19	39 / 32 / 26 / 20	48 / 35 / 28 / 22
Air flow	Indoor	Heating (P-Hi/Hi/Me/Lo)	36 / 28 / 25 / 19	39 / 32 / 26 / 20	48 / 35 / 28 / 22
		Cooling/Heating	75 / 73	75 / 73	75 / 73
External static pressure*2		Pa	Standard:60 Max:200		
Exterior dimensions	Indoor	HeightxWidthxDepth	mm	280 x 1,370 x 740	
	Outdoor			845 x 970 x 370	
Net weight	Indoor		kg	54	
	Outdoor			80	
Ref.piping size	Liquid/Gas	ømm	9.52(3/8") / 15.88(5/8")		
Refrigerant line (one way) length			Max.50		
Vertical height differences			Outdoor is higher/lower		
Outdoor operating temperature range			Max.50 / Max.15		
Cooling			-15~50*3		
Heating			-20~20		
Air filter			Procure locally		
Remote control (option)			wired:RC-EX3A, RC-E5, RCH-E3 wireless:RCN-KIT4-E2		

## SPECIFICATIONS -FDU-

R410A		Micro Inverter		
Set model name		FDU100VSAVH	FDU125VSAVH	FDU140VSAVH
Indoor unit		FDU100VH	FDU125VH	FDU140VH
Outdoor unit		FDC100VSA	FDC125VSA	FDC140VSA
Power source		3 Phase 380-415V, 50Hz / 380V, 60Hz		
Nominal cooling capacity (Min~Max)	kW	10.0 ( 4.0 ~ 11.2 )	12.5 ( 5.0 ~ 14.0 )	13.6 ( 5.0 ~ 14.5 )
Nominal heating capacity (Min~Max)	kW	11.2 ( 4.0 ~ 12.5 )	14.0 ( 4.0 ~ 16.0 )	15.5 ( 4.0 ~ 16.5 )
Power consumption	Cooling/Heating kW	2.84 / 2.78	4.36 / 3.69	4.93 / 4.21
EER/COP	Cooling/Heating	3.52 / 4.03	2.87 / 3.79	2.76 / 3.68
Inrush current		5	5	5
Max. current		17	17	18
Sound power level*1	Indoor	Cooling/Heating	65 / 65	67 / 67
	Outdoor	Cooling/Heating	70 / 70	71 / 71
Sound pressure level*1	Indoor	Cooling (P-Hi/Hi/Me/Lo)	44 / 38 / 36 / 30	45 / 40 / 34 / 29
	Outdoor	Heating (P-Hi/Hi/Me/Lo)	44 / 38 / 36 / 30	45 / 40 / 34 / 29
Air flow	Indoor	Cooling/Heating	54 / 56	55 / 57
	Outdoor	Cooling/Heating	36 / 28 / 25 / 19	39 / 32 / 26 / 20
Air flow	Indoor	Cooling (P-Hi/Hi/Me/Lo)	36 / 28 / 25 / 19	39 / 32 / 26 / 20
	Outdoor	Heating (P-Hi/Hi/Me/Lo)	36 / 28 / 25 / 19	39 / 32 / 26 / 20
External static pressure*2	Pa	Standard:60 Max:200		
Exterior dimensions	Indoor	HeightxWidthxDepth	280 x 1,370 x 740	
	Outdoor	HeightxWidthxDepth	845 x 970 x 370	
Net weight	Indoor		54	
	Outdoor		82	
Ref.piping size	Liquid/Gas	ømm	9.52(3/8") / 15.88(5/8")	
Refrigerant line (one way) length		m	Max.50	
Vertical height differences	Outdoor is higher/lower	m	Max.50 / Max.15	
Outdoor operating temperature range	Cooling	°CDB	-15~50*3	
	Heating	°CWB	-20~20	
Air filter			Procure locally	
Remote control (option)			wired:RC-EX3A, RC-E5, RCH-E3 wireless:RCN-KIT4-E2	

R410A		Micro Inverter		
Set model name		FDU200VSAVH	FDU250VSAVH	
Indoor unit		FDU200VH	FDU250VH	
Outdoor unit		FDC200VSA	FDC250VSA	
Power source		3 Phase 380-415V, 50Hz / 380V, 60Hz		
Nominal cooling capacity (Min~Max)	kW	19.0 ( 5.2 ~ 22.4 )	24.0 ( 6.9 ~ 28.0 )	
Nominal heating capacity (Min~Max)	kW	22.4 ( 3.3 ~ 25.0 )	27.0 ( 5.5 ~ 31.5 )	
Power consumption	Cooling/Heating kW	6.15 / 6.03	7.98 / 7.20	
EER/COP	Cooling/Heating	3.09 / 3.71	3.01 / 3.75	
Inrush current		5	5	
Max. current		25	27	
Sound power level*1	Indoor	Cooling/Heating	78 / 78	
	Outdoor	Cooling/Heating	72 / 74	
Sound pressure level*1	Indoor	Cooling (P-Hi/Hi/Me/Lo)	52 / 50 / 47 / 45	
	Outdoor	Heating (P-Hi/Hi/Me/Lo)	52 / 50 / 47 / 44	
Air flow	Indoor	Cooling/Heating	58 / 59	
	Outdoor	Cooling (P-Hi/Hi/Me/Lo)	80 / 72 / 64 / 56	
Air flow	Indoor	Heating (P-Hi/Hi/Me/Lo)	80 / 72 / 64 / 56	
	Outdoor	Cooling/Heating	135 / 135	
External static pressure*2	Pa	Standard:72 Max:200		
Exterior dimensions	Indoor	HeightxWidthxDepth	379 x 1,600 x 893	
	Outdoor	HeightxWidthxDepth	1,300 x 970 x 370	
Net weight	Indoor		88	
	Outdoor		143	
Ref.piping size	Liquid/Gas	ømm	9.52(3/8") / 22.22(7/8")	
Refrigerant line (one way) length		m	Max.70	
Vertical height differences	Outdoor is higher/lower	m	Max.30 / Max.15	
Outdoor operating temperature range	Cooling	°CDB	-15~50*3	
	Heating	°CWB	-15~20	
Air filter			Procure locally	
Remote control (option)			wired:RC-EX3A, RC-E5, RCH-E3 wireless:RCN-KIT4-E2	

### NOTES:

The data are measured under the following conditions(R32 : ISO-T1, -H1 / , R410A : ISO-T1).  
Cooling:Indoor temp. of 27°CDB, 19°CWB, and outdoor temp. of 35°CDB. Heating:Indoor temp. of 20°CDB, and outdoor temp. of 7°CDB, 6°CWB.  
\*1 : Indicates the value in an anechoic chamber. During operation these values are somewhat higher due to ambient conditions.  
\*2 : External static pressure is changeable to be set by the remote control. MAX external static pressure is "High static pressure" setting. The values of sound pressure level become 5dB(A) higher at external static pressure of 200Pa.  
\*3 : If a cooling operation is conducted when the outdoor air temperature is -5°C or lower, the outdoor unit should be installed at a place where it is not influenced by natural wind. If wind blows, the low pressure will drop and compressor frequency will increase, this will cause the capacity to drop and may cause the unit to break down.

R32		Standard Inverter			
Set model name		FDU71VNPVH	FDU90VNPVH	FDU100VNPVH	FDU125VNPVH
Indoor unit		FDU71VH	FDU100VH	FDU100VH	FDU125VH
Outdoor unit		FDC71VNP-W	FDC90VNP-W	FDC100VNP-W	FDC125VNP-W
Power source		1 Phase 220-240V, 50Hz / 220V, 60Hz			
Nominal cooling capacity (Min-Max)	kW	7.1 ( 1.5 ~ 7.3 )	9.0 ( 2.1 ~ 9.5 )	10.0 ( 2.1 ~ 10.2 )	12.1 ( 5.0 ~ 12.1 )
Nominal heating capacity (Min-Max)	kW	7.1 ( 1.1 ~ 7.3 )	9.0 ( 1.7 ~ 9.5 )	10.0 ( 1.7 ~ 10.4 )	12.1 ( 4.0 ~ 13.3 )
Power consumption	Cooling/Heating	2.60 / 1.89	2.62 / 1.98	3.08 / 2.45	3.85 / 3.28
EER/COP	Cooling/Heating	2.73. / 3.76	3.44 / 4.55	3.25 / 4.08	3.14 / 3.69
Inrush current		5	5	5	5
Max. current		15.8	19	19	20
Sound power level*1	Indoor	Cooling/Heating	65 / 65	65 / 65	65 / 65
	Outdoor	Cooling/Heating	67 / 67	67 / 66	68 / 67
Sound pressure level*1	Indoor	Cooling (P-Hi/Hi/Me/Lo)	38 / 33 / 29 / 25	44 / 38 / 36 / 30	44 / 38 / 36 / 30
		Heating (P-Hi/Hi/Me/Lo)	38 / 33 / 29 / 25	44 / 38 / 36 / 30	44 / 38 / 36 / 30
	Outdoor	Cooling/Heating	54 / 54	55 / 53	56 / 54
Air flow	Indoor	Cooling (P-Hi/Hi/Me/Lo)	24 / 19 / 15 / 10	36 / 28 / 25 / 19	36 / 28 / 25 / 19
		Heating (P-Hi/Hi/Me/Lo)	24 / 19 / 15 / 10	36 / 28 / 25 / 19	36 / 28 / 25 / 19
	Outdoor	Cooling/Heating	42 / 42	59 / 55	63 / 55
External static pressure*2	Pa	Standard:35 Max:200	Standard:60 Max:200		
Exterior dimensions	Indoor	HeightxWidthxDepth	280 x 950 x 635	280 x 1,370 x 740	
	Outdoor		640 x 800(+71) x 290	750 x 880(+88) x 340	845 x 970 x 370
Net weight	Indoor		34	54	
	Outdoor		45	57	73
Ref.piping size	Liquid/Gas	ømm	6.35(1/4") / 12.7(1/2")	6.35(1/4") / 15.88(5/8")	
Refrigerant line (one way) length		m	Max.30	Max.30	
Vertical height differences	Outdoor is higher/lower	m	Max.20 / Max.20	Max.20 / Max.20	
Outdoor operating temperature range	Cooling	°CDB	-15~46*3		
	Heating	°CWB	-15~20		
Air filter			Procure locally		
Remote control (option)			wired:RC-EX3A, RC-E5, RCH-E3 wireless:RCN-KIT4-E2		

R410A		Standard Inverter			
Set model name		FDU71VNPVH	FDU90VNP1VH	FDU100VNP1VH	
Indoor unit		FDU71VH	FDU100VH	FDU100VH	
Outdoor unit		FDC71VNP	FDC90VNP1	FDC100VNP	
Power source		1 Phase 220-240V, 50Hz / 220V, 60Hz			
Nominal cooling capacity (Min-Max)	kW	7.1 ( 1.4 ~ 7.1 )	9.0 ( 1.9 ~ 9.0 )	10.0 ( 2.8 ~ 11.2 )	
Nominal heating capacity (Min-Max)	kW	7.1 ( 1.0 ~ 7.1 )	9.0 ( 1.5 ~ 9.0 )	11.2 ( 2.5 ~ 12.5 )	
Power consumption	Cooling/Heating	2.60 / 1.89	2.69 / 2.25	3.00 / 2.93	
EER/COP	Cooling/Heating	2.73. / 3.76	3.35 / 4.00	3.33 / 3.82	
Inrush current		5	5	5	
Max. current		14.5	18	22	
Sound power level*1	Indoor	Cooling/Heating	65 / 65	65 / 65	
	Outdoor	Cooling/Heating	67 / 67	69 / 69	
Sound pressure level*1	Indoor	Cooling (P-Hi/Hi/Me/Lo)	38 / 33 / 29 / 25	44 / 38 / 36 / 30	
		Heating (P-Hi/Hi/Me/Lo)	38 / 33 / 29 / 25	44 / 38 / 36 / 30	
	Outdoor	Cooling/Heating	54 / 54	57 / 55	
Air flow	Indoor	Cooling (P-Hi/Hi/Me/Lo)	24 / 19 / 15 / 10	36 / 28 / 25 / 19	
		Heating (P-Hi/Hi/Me/Lo)	24 / 19 / 15 / 10	36 / 28 / 25 / 19	
	Outdoor	Cooling/Heating	36 / 36	63 / 49.5	
External static pressure*2	Pa	Standard:35 Max:200	Standard:60 Max:200		
Exterior dimensions	Indoor	HeightxWidthxDepth	280 x 950 x 635	280 x 1,370 x 740	
	Outdoor		640 x 800(+71) x 290	750 x 880(+88) x 340	845 x 970 x 370
Net weight	Indoor		34	54	
	Outdoor		45	57	70
Ref.piping size	Liquid/Gas	ømm	6.35(1/4") / 12.7(1/2")	6.35(1/4") / 15.88(5/8")	
Refrigerant line (one way) length		m	Max.30	Max.30	
Vertical height differences	Outdoor is higher/lower	m	Max.20 / Max.20	Max.20 / Max.20	
Outdoor operating temperature range	Cooling	°CDB	-15~46*3		
	Heating	°CWB	-15~20		
Air filter			Procure locally		
Remote control (option)			wired:RC-EX3A, RC-E5, RCH-E3 wireless:RCN-KIT4-E2		

# FDUM

Indoor Unit  
**Duct Connected**  
**-Low/Middle Static pressure-**

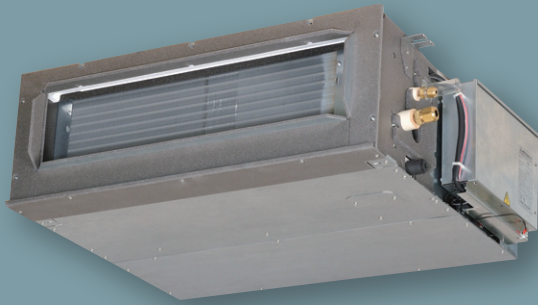

FDUM 40/50/60/71/100/125/140

Filter kit (option)



UM-FL1EF : for 40, 50  
 UM-FL2EF : for 60, 71  
 UM-FL3EF : for 100, 125, 140  
 external static pressure loss:5Pa

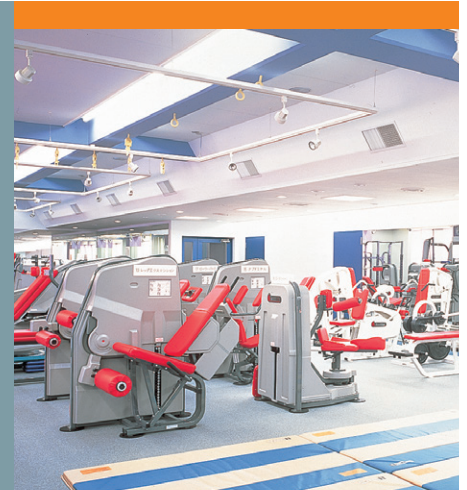

- Energy Saving
- Automatic Operation
- Silent Operation
- Hi Power
- Weekly/Sleep/Peak-Cut Timer
- Self-Diagnostics



Remote control (option)

Wired			Wireless	
RC-EX3A RC-EXZ3A	RC-E5	RCH-E3	RCN-KIT4-E2	

\*Not all functions available with all remote control options.

## Thin Design

The height of all FDUM models is only 280mm.

FDUM100/125/140		FDUM40/50/60/71	
70mm less		19mm less	
H 350mm	H 280mm	H 299mm	H 280mm

## Motion Sensor (Option)

New

Motion sensor is equipped in the ceiling plane or wall plane and detects the presence/absence and activity of humans in a room to improve the comfort and energy saving performance of the unit.

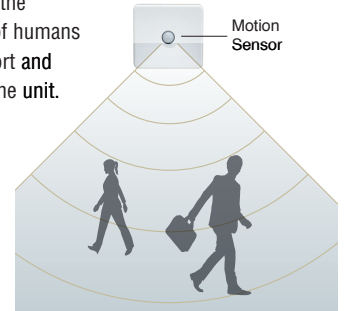

## Automatic External Static Pressure (E.S.P.) Control

Duct design was simplified. Using DC motor, the most optimum air flow volume can be achieved by this automatic control. Indoor unit will recognize external static pressure by itself automatically and keep rated air flow volume.

RC-E5  
 E.S.P. button

External Static Pressure (E.S.P.) can be set by E.S.P. button.

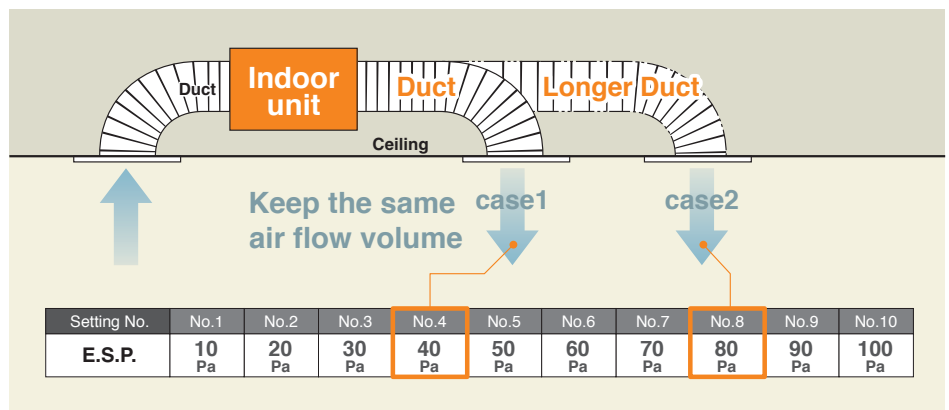

## Zoning system

Effectively control temperatures of multiple rooms with one indoor duct unit. (Please refer to P51)

## Improvement of the Serviceability

Fan unit (impeller and motor) can be pulled out from the right side of the unit. Maintenance can be carried out from the right side or the bottom side of the unit.

## Transparent Inspection Window

Dirt condition of the bottom of a drain pan can be checked through this transparent inspection window without removing drain pan. (Please refer to P52)

## Enhanced Installation Workability

600mm Drain Pump is mounted in all models. The indoor unit is completely hidden in the ceiling, so this is suitable for spaces with classy interior decoration.

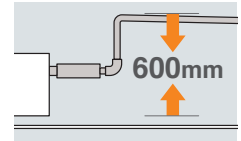

## OUTDOOR UNIT

		Hyper Inverter		
SRC · FDC		40~60ZSX-W1,-W2	71VNX-W	100~140VN(S)X-W
		40~60ZSX-S	71VNX	100~140VN(S)X
model				
Chargeless		15m	30m	
Height x Width x Depth (mm)		640 x 800(+71) x 290	750 x 880(+88) x 340	1,300 x 970 x 370

		Micro Inverter			Standard Inverter		
FDC		100~140VN(S)A-W	-	200·250·280VSA-W	71VNP-W	90·100VNP-W	125VNP-W
		100~140VN(S)A	200VSA	250VSA	71VNP	90VNP1	100VNP
model							
Chargeless		30m			15m		
Height x Width x Depth (mm)		845 x 970 x 370	1,300 x 970 x 370	1,505 x 970 x 370	640 x 800(+71) x 290	750 x 880(+88) x 340	845 x 970 x 370

## DIMENSIONS (Unit:mm) - FDUM -

### Models FDUM40VH, 50VH

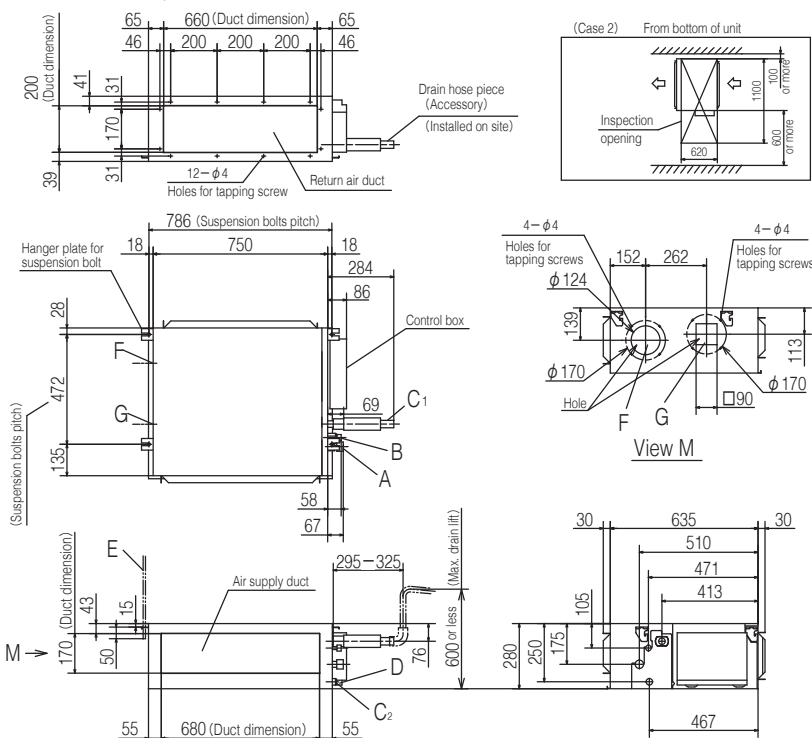

Symbol	Content
A	Gas piping $\phi 12.7$ (1/2") (Flare)
B	Liquid piping $\phi 6.35$ (1/4") (Flare)
C1	Drain piping VP25 (O.D.32)
C2	Drain piping (Gravity drainage) VP20
D	Hole for wiring
E	Suspension bolts (M10)
F	Outside air opening for ducting ( $\phi 150$ ) (Knock out)
G	Air outlet opening for ducting ( $\phi 125$ ) (Knock out)
H	Inspection opening (450×450)

Note(1) The model name label is attached on the lid of the control box.

### Space for installation and service

Select either of two cases to keep space for installation and services.  
(Case 1) From side of unit

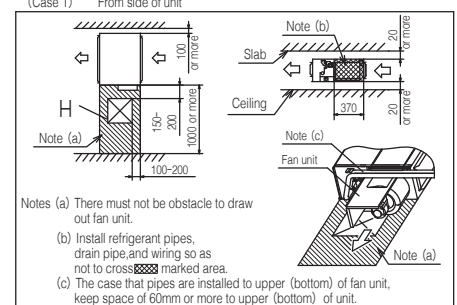

# DIMENSIONS (Unit:mm) - FDUM -

## Models FDUM60VH,71VH

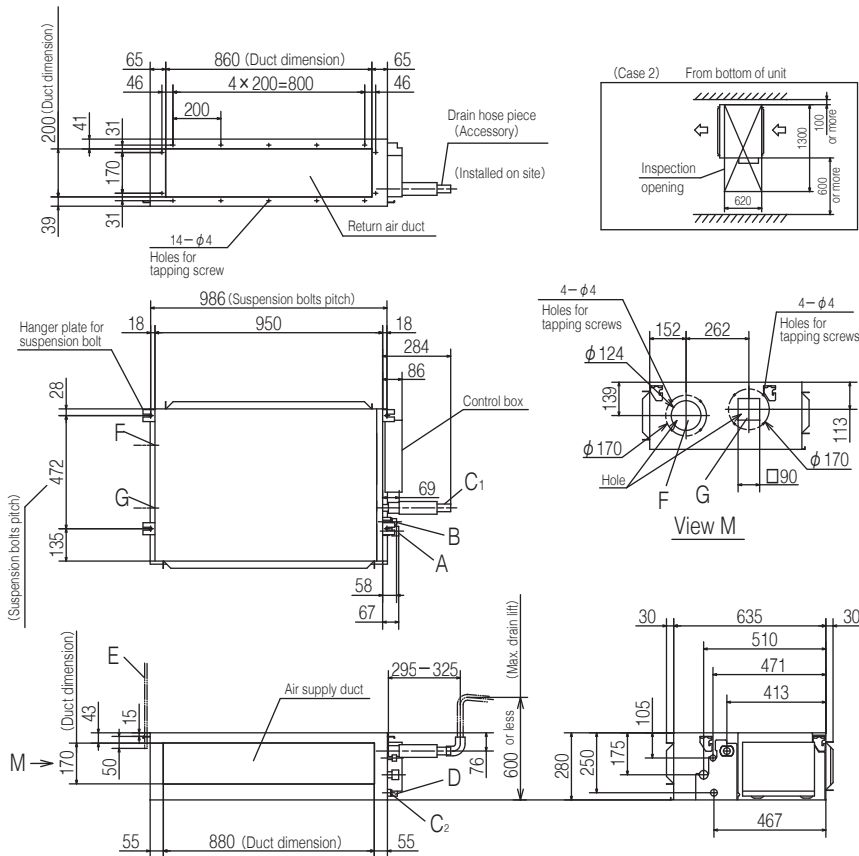

Symbol	Content	
	Model 60	71
A	Gas piping φ12.7 (1/2") (Flare)	φ15.88 (5/8") (Flare)
B	Liquid piping φ6.35 (1/4") (Flare)	φ9.52 (3/8") (Flare)
C1	Drain piping	VP25 (O.D.32)
C2	Drain piping (Gravity drainage)	VP20
D	Hole for wiring	
E	Suspension bolts	(M10)
F	Outside air opening for ducting	(φ150) (Knock out)
G	Air outlet opening for ducting	(φ125) (Knock out)
H	Inspection opening	(450×450)

Note(1) The model name label is attached on the lid of the control box.

### Space for installation and service

Select either of two cases to keep space for installation and services.

(Case 1) From side of unit

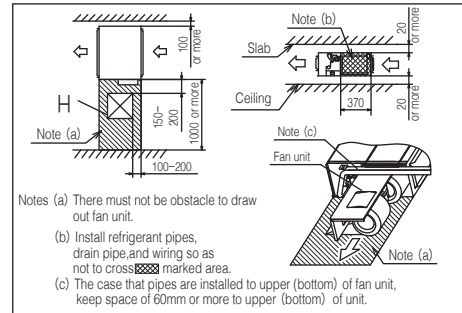

## Models FDUM100VH,125VH,140VH

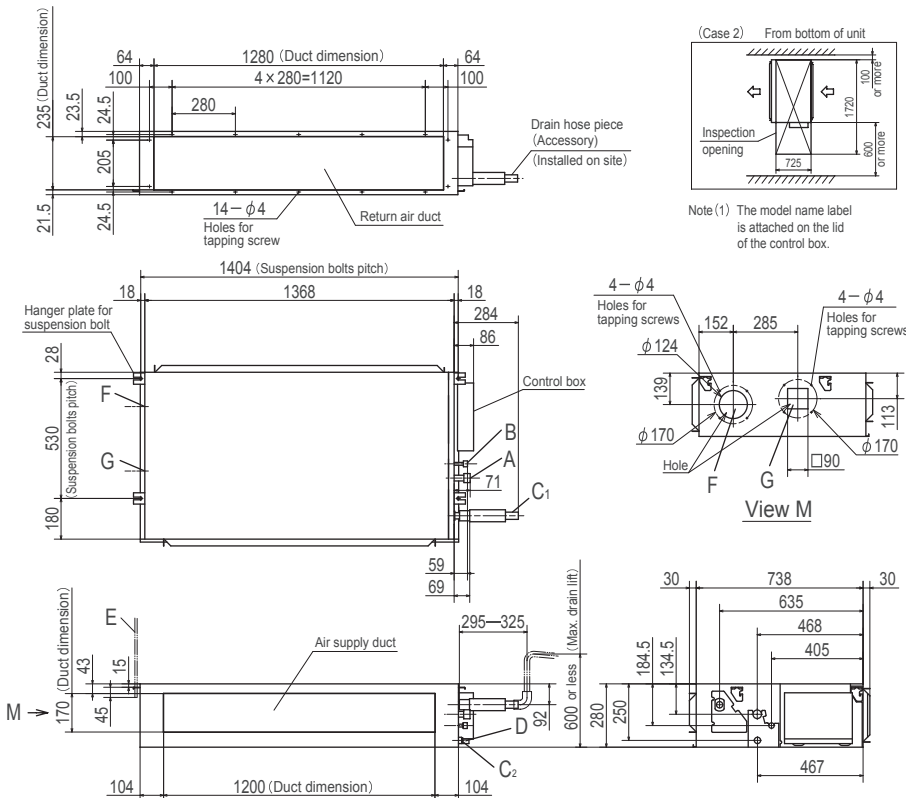

Note(1) The model name label is attached on the lid of the control box.



Symbol	Content	
A	Gas piping φ15.88 (5/8") (Flare)	
B	Liquid piping φ9.52 (3/8") (Flare)	
C1	Drain piping	VP25 (O.D.32)
C2	Drain piping (Gravity drainage)	VP20
D	Hole for wiring	
E	Suspension bolts	(M10)
F	Outside air opening for ducting	(φ150) (Knock out)
G	Air outlet opening for ducting	(φ125) (Knock out)
H	Inspection opening	(450×450)

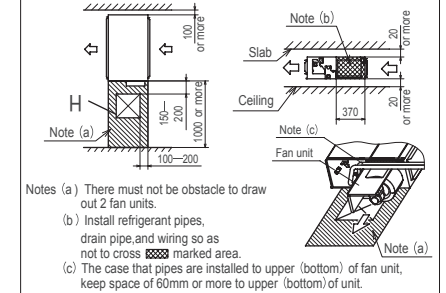

### Space for installation and service

Select either of two cases to keep space for installation and services.

(Case 1) From side of unit



					
Set model name		FDUM40ZSXW1VH	FDUM50ZSXW2VH	FDUM60ZSXW1VH	
Indoor unit		FDUM40VH	FDUM50VH	FDUM60VH	
Outdoor unit		SRC40ZSX-W1	SRC50ZSX-W2	SRC60ZSX-W1	
Power source		1 Phase 220-240V, 50Hz / 220V, 60Hz			
Nominal cooling capacity (Min~Max)		kW 4.0 ( 1.1 ~ 4.7 )	5.0 ( 1.1 ~ 5.6 )	5.6 ( 1.1 ~ 6.3 )	
Nominal heating capacity (Min~Max)		kW 4.5 ( 0.6 ~ 5.4 )	5.4 ( 0.6 ~ 6.3 )	6.7 ( 0.6 ~ 7.1 )	
Power consumption	Cooling/Heating	kW 1.10 / 1.10	1.51 / 1.59	1.54 / 1.75	
EER/COP	Cooling/Heating	3.62 / 4.09	3.31 / 3.39	3.64 / 3.83	
Inrush current		A 5	5	5	
Max. current		15	15	15	
Sound power level*1	Indoor	Cooling/Heating	60 / 60	60 / 60	
	Outdoor	Cooling/Heating	63 / 62	65 / 65	
Sound pressure level*1	Indoor	Cooling (P-Hi/Hi/Me/Lo)	37 / 32 / 29 / 26	37 / 32 / 29 / 26	
		Heating (P-Hi/Hi/Me/Lo)	37 / 32 / 29 / 26	36 / 31 / 28 / 25	
	Outdoor	Cooling/Heating	52 / 50	53 / 54	
		Cooling (P-Hi/Hi/Me/Lo)	13 / 10 / 9 / 8	20 / 15 / 13 / 10	
Air flow	Indoor	Heating (P-Hi/Hi/Me/Lo)	13 / 10 / 9 / 8	20 / 15 / 13 / 10	
		Cooling/Heating	33 / 33	41.5 / 39	
External static pressure*2		Pa	Standard:35 Max:100		
Exterior dimensions	Indoor	HeightxWidthxDepth	280 x 750 x 635		280 x 950 x 635
	Outdoor		640 x 800(+71) x 290		
Net weight	Indoor		29		34
	Outdoor		45		
Ref.piping size	Liquid/Gas	ømm	6.35(1/4") / 12.7(1/2")		
Refrigerant line (one way) length		m	Max.30		
Vertical height differences		Outdoor is higher/lower	Max.20 / Max.20		
Outdoor operating temperature range	Cooling	°CDB	-15~46*3		
	Heating	°CWB	-20~20		
Air filter (option)			Filter kit : UM-FL1EF		Filter kit : UM-FL2EF
Remote control (option)			wired:RC-EX3A, RC-E5, RCH-E3 wireless:RCN-KIT4-E2		

					
Set model name		FDUM71VNXWVH	FDUM100VNXWVH	FDUM125VNXWVH	FDUM140VNXWVH
Indoor unit		FDUM71VH	FDUM100VH	FDUM125VH	FDUM140VH
Outdoor unit		FDC71VNX-W	FDC100VNX-W	FDC125VNX-W	FDC140VNX-W
Power source		1 Phase 220-240V, 50Hz / 220V, 60Hz			
Nominal cooling capacity (Min~Max)		kW 7.1 ( 3.2 ~ 8.0 )	10.0 ( 3.5 ~ 11.2 )	12.5 ( 3.5 ~ 14.0 )	14.0 ( 3.5 ~ 16.0 )
Nominal heating capacity (Min~Max)		kW 8.0 ( 3.6 ~ 9.0 )	11.2 ( 2.7 ~ 12.5 )	14.0 ( 2.7 ~ 17.0 )	16.0 ( 2.7 ~ 18.0 )
Power consumption	Cooling/Heating	kW 1.77 / 1.78	2.59 / 2.63	3.49 / 3.61	4.22 / 4.22
EER/COP	Cooling/Heating	4.01 / 4.49	3.86 / 4.26	3.58 / 3.88	3.32 / 3.79
Inrush current		A 5	5	5	5
Max. current		20	26	28	30
Sound power level*1	Indoor	Cooling/Heating	65 / 65	67 / 67	70 / 70
	Outdoor	Cooling/Heating	66 / 66	67 / 67	69 / 71
Sound pressure level*1	Indoor	Cooling (P-Hi/Hi/Me/Lo)	38 / 33 / 29 / 25	44 / 38 / 36 / 30	47 / 40 / 35 / 30
		Heating (P-Hi/Hi/Me/Lo)	38 / 33 / 29 / 25	44 / 38 / 36 / 30	47 / 40 / 35 / 30
	Outdoor	Cooling/Heating	51 / 51	53 / 51	54 / 54
		Cooling (P-Hi/Hi/Me/Lo)	24 / 19 / 15 / 10	36 / 28 / 25 / 19	39 / 32 / 26 / 20
Air flow	Indoor	Heating (P-Hi/Hi/Me/Lo)	24 / 19 / 15 / 10	36 / 28 / 25 / 19	48 / 35 / 28 / 22
		Cooling/Heating	60 / 50	100 / 100	100 / 100
External static pressure*2		Pa	Standard:35 Max:100	Standard:60 Max:100	
Exterior dimensions	Indoor	HeightxWidthxDepth	280 x 950 x 635		280 x 1,370 x 740
	Outdoor		750 x 880(+88) x 340		
Net weight	Indoor		34		54
	Outdoor		60		
Ref.piping size	Liquid/Gas	ømm	9.52(3/8") / 15.88(5/8")		
Refrigerant line (one way) length		m	Max.50		Max.100
Vertical height differences		Outdoor is higher/lower	Max.30 / Max.15		
Outdoor operating temperature range	Cooling	°CDB	-15~50*3		
	Heating	°CWB	-20~20		
Air filter (option)			Filter kit : UM-FL2EF		Filter kit : UM-FL3EF
Remote control (option)			wired:RC-EX3A, RC-E5, RCH-E3 wireless:RCN-KIT4-E2		

**NOTES:**

The data are measured under the following conditions(ISO-T1, -H1).  
 Cooling:Indoor temp. of 27°CDB, 19°CWB, and outdoor temp. of 35°CDB. Heating:Indoor temp. of 20°CDB, and outdoor temp. of 7°CDB, 6°CWB.  
 \*1 : Indicates the value in an anechoic chamber. During operation these values are somewhat higher due to ambient conditions.  
 \*2 : External static pressure is changeable to be set by the remote control. MAX external static pressure is "High static pressure" setting. The values of sound pressure level become 5dB(A) higher at external static pressure of 100Pa.  
 \*3 : If a cooling operation is conducted when the outdoor air temperature is -5°C or lower, the outdoor unit should be installed at a place where it is not influenced by natural wind. If wind blows, the low pressure will drop and compressor frequency will increase, this will cause the capacity to drop and may cause the unit to break down.

## SPECIFICATIONS - FDUM -

R32		Hyper Inverter		
Set model name		FDUM100VSXWVH	FDUM125VSXWVH	FDUM140VSXWVH
Indoor unit		FDUM100VH	FDUM125VH	FDUM140VH
Outdoor unit		FDC100VSX-W	FDC125VSX-W	FDC140VSX-W
Power source		3 Phase 380-415V, 50Hz / 380V, 60Hz		
Nominal cooling capacity (Min~Max)		kW 10.0 (3.5 ~ 11.2)	12.5 (3.5 ~ 14.0)	14.0 (3.5 ~ 16.0)
Nominal heating capacity (Min~Max)		kW 11.2 (2.7 ~ 16.0)	14.0 (2.7 ~ 18.0)	16.0 (2.7 ~ 20.0)
Power consumption		Cooling/Heating kW 2.59 / 2.63	3.49 / 3.61	4.22 / 4.22
EER/COP		Cooling/Heating 3.86 / 4.26	3.58 / 3.88	3.32 / 3.79
Inrush current		A 5	5	5
Max. current		15	16	17
Sound power level*1	Indoor	Cooling/Heating 65 / 65	67 / 67	70 / 70
	Outdoor	Cooling/Heating 67 / 67	68 / 70	69 / 71
Sound pressure level*1	Indoor	Cooling (P-Hi/Hi/Me/Lo) dB(A) 44 / 38 / 36 / 30	45 / 40 / 34 / 29	47 / 40 / 35 / 30
	Outdoor	Heating (P-Hi/Hi/Me/Lo) 44 / 38 / 36 / 30	45 / 40 / 34 / 29	47 / 40 / 35 / 30
Air flow	Indoor	Cooling (P-Hi/Hi/Me/Lo) m³/min 36 / 28 / 25 / 19	39 / 32 / 26 / 20	48 / 35 / 28 / 22
	Outdoor	Heating (P-Hi/Hi/Me/Lo) 36 / 28 / 25 / 19	39 / 32 / 26 / 20	48 / 35 / 28 / 22
External static pressure*2		Pa 100 / 100	100 / 100	100 / 100
Exterior dimensions	Indoor	HeightxWidthxDepth mm 280 x 1,370 x 740	Standard:60 Max:100	
	Outdoor	1,300 x 970 x 370		
Net weight	Indoor	kg 54		
	Outdoor	99		
Ref.piping size		Liquid/Gas ømm 9.52(3/8") / 15.88(5/8")		
Refrigerant line (one way) length		m Max.100		
Vertical height differences		Outdoor is higher/lower m Max.50 / Max.15		
Outdoor operating temperature range	Cooling	°CDB -15~50*3		
	Heating	°CWB -20~20		
Air filter (option)		Filter kit : UM-FL3EF		
Remote control (option)		wired:RC-EX3A, RC-E5, RCH-E3 wireless:RCN-KIT4-E2		

The values are for simultaneous Multi operation.

R32		Hyper Inverter				
Set model name		FDUM71VNXWPVH	FDUM100VNXWPVH	FDUM125VNXWPVH	FDUM140VNXWPVH	FDUM140VNXWTVH
Indoor unit		FDUM40VH x 2	FDUM50VH x 2	FDUM60VH x 2	FDUM71VH x 2	FDUM50VH x 3
Outdoor unit		FDC71VNX-W	FDC100VNX-W	FDC125VNX-W	FDC140VNX-W	FDC140VNX-W
Power source		1 Phase 220-240V, 50Hz / 220V, 60Hz				
Nominal cooling capacity (Min~Max)		kW 7.1 (3.2 ~ 8.0)	10.0 (3.5 ~ 11.2)	12.5 (3.5 ~ 14.0)	14.0 (3.5 ~ 16.0)	14.0 (3.5 ~ 16.0)
Nominal heating capacity (Min~Max)		kW 8.0 (3.6 ~ 9.0)	11.2 (2.7 ~ 12.5)	14.0 (2.7 ~ 17.0)	16.0 (2.7 ~ 18.0)	16.0 (2.7 ~ 18.0)
Power consumption		Cooling/Heating kW 1.76 / 1.80	2.66 / 2.96	3.26 / 3.26	3.97 / 3.91	4.03 / 4.04
EER/COP		Cooling/Heating 4.03 / 4.44	3.76 / 3.79	3.83 / 4.30	3.53 / 4.10	3.48 / 3.96
Inrush current		A 5	5	5	5	5
Max. current		20	26	28	30	30
Sound power level*1	Indoor*4	Cooling/Heating 60 / 60	60 / 60	60 / 60	65 / 65	60 / 60
	Outdoor	Cooling/Heating 66 / 66	67 / 67	68 / 70	69 / 71	69 / 71
Sound pressure level*1	Indoor*4	Cooling (P-Hi/Hi/Me/Lo) dB(A) 37 / 32 / 29 / 26	37 / 32 / 29 / 26	36 / 31 / 28 / 25	38 / 33 / 29 / 25	37 / 32 / 29 / 26
	Outdoor	Heating (P-Hi/Hi/Me/Lo) 37 / 32 / 29 / 26	37 / 32 / 29 / 26	36 / 31 / 28 / 25	38 / 33 / 29 / 25	37 / 32 / 29 / 26
Air flow	Indoor*4	Cooling (P-Hi/Hi/Me/Lo) m³/min 13 / 10 / 9 / 8	13 / 10 / 9 / 8	20 / 15 / 13 / 10	24 / 19 / 15 / 10	13 / 10 / 9 / 8
	Outdoor	Heating (P-Hi/Hi/Me/Lo) 13 / 10 / 9 / 8	13 / 10 / 9 / 8	20 / 15 / 13 / 10	24 / 19 / 15 / 10	13 / 10 / 9 / 8
External static pressure*2		Pa 60 / 50	100 / 100	100 / 100	100 / 100	100 / 100
Exterior dimensions	Indoor	HeightxWidthxDepth mm 280 x 750 x 635	Standard:35 Max:100		280 x 950 x 635	
	Outdoor	750 x 880(+88) x 340	1,300 x 970 x 370		280 x 750 x 635	
Net weight	Indoor	kg 29	34		29	
	Outdoor	60	97			
Ref.piping size		Liquid/Gas ømm 9.52(3/8") / 15.88(5/8")				
Refrigerant line (one way) length		m Max.50	Max.100			
Vertical height differences		Outdoor is higher/lower m Max.30 / Max.15	Max.50 / Max.15			
Outdoor operating temperature range	Cooling	°CDB -15~50*3				
	Heating	°CWB -20~20				
Air filter (option)		Filter kit : UM-FL1EF		Filter kit : UM-FL2EF		Filter kit : UM-FL1EF
Remote control (option)		wired:RC-EX3A, RC-E5, RCH-E3 wireless:RCN-KIT4-E2				

### NOTES:

<p>The data are measured under the following conditions(ISO-T1, -H1 / R410A : ISO-T1).  Cooling:Indoor temp. of 27°CDB, 19°CWB, and outdoor temp. of 35°CDB. Heating:Indoor temp. of 20°CDB, and outdoor temp. of 7°CDB, 6°CWB.  *1 : Indicates the value in an anechoic chamber. During operation these values are somewhat higher due to ambient conditions.  *2 : External static pressure is changeable to be set by the remote control. MAX external static pressure is "High static pressure" setting. The values of sound pressure level become 5dB(A) higher at external static pressure of 100Pa.  *3 : If a cooling operation is conducted when the outdoor air temperature is -5°C or lower, the outdoor unit should be installed at a place where it is not influenced by natural wind. If wind blows, the low pressure will drop and compressor frequency will increase, this will cause the capacity to drop and may cause the unit to break down.  *4 : The values are for one indoor unit operation. (Multi system only)</p>
--



The values are for simultaneous Multi operation.

R32			Hyper Inverter			
Set model name			FDUM100VSXWPVH	FDUM125VSXWPVH	FDUM140VSXWPVH	FDUM140VSXWTVH
			Twin		Triple	
Indoor unit			FDUM50VH x 2	FDUM60VH x 2	FDUM71VH x 2	FDUM50VH x 3
Outdoor unit			FDC100VSX-W	FDC125VSX-W	FDC140VSX-W	FDC140VSX-W
Power source			3 Phase 380-415V, 50Hz / 380V, 60Hz			
Nominal cooling capacity (Min~Max)	kW		10.0 ( 3.5 ~ 11.2 )	12.5 ( 3.5 ~ 14.0 )	14.0 ( 3.5 ~ 16.0 )	14.0 ( 3.5 ~ 16.0 )
Nominal heating capacity (Min~Max)	kW		11.2 ( 2.7 ~ 16.0 )	14.0 ( 2.7 ~ 18.0 )	16.0 ( 2.7 ~ 20.0 )	16.0 ( 2.7 ~ 20.0 )
Power consumption	Cooling/Heating	kW	2.66 / 2.96	3.26 / 3.26	3.97 / 3.91	4.03 / 4.04
EER/COP	Cooling/Heating		3.76 / 3.79	3.83 / 4.30	3.53 / 4,10	3.48 / 3.96
Inrush current		A	5	5	5	5
Max. current			15	16	17	17
Sound power level*1	Indoor*4	Cooling/Heating	60 / 60	60 / 60	65 / 65	60 / 60
	Outdoor	Cooling/Heating	67 / 67	68 / 70	69 / 71	69 / 71
Sound pressure level*1	Indoor*4	Cooling (P-Hi/Hi/Me/Lo)	37 / 32 / 29 / 26	36 / 31 / 28 / 25	38 / 33 / 29 / 25	37 / 32 / 29 / 26
		Heating (P-Hi/Hi/Me/Lo)	37 / 32 / 29 / 26	36 / 31 / 28 / 25	38 / 33 / 29 / 25	37 / 32 / 29 / 26
	Outdoor	Cooling/Heating	53 / 51	53 / 54	54 / 54	54 / 54
Air flow	Indoor*4	Cooling (P-Hi/Hi/Me/Lo)	13 / 10 / 9 / 8	20 / 15 / 13 / 10	24 / 19 / 15 / 10	13 / 10 / 9 / 8
		Heating (P-Hi/Hi/Me/Lo)	13 / 10 / 9 / 8	20 / 15 / 13 / 10	24 / 19 / 15 / 10	13 / 10 / 9 / 8
	Outdoor	Cooling/Heating	100 / 100	100 / 100	100 / 100	100 / 100
External static pressure*2		Pa	Standard:35 Max:100			
Exterior dimensions	Indoor	HeightxWidthxDepth	mm	280 x 750 x 635	280 x 950 x 635	280 x 750 x 635
	Outdoor		mm	1,300 x 970 x 370		
Net weight	Indoor		kg	29	34	29
	Outdoor		kg	99		
Ref.piping size	Liquid/Gas	ømm	9.52(3/8") / 15.88(5/8")			
Refrigerant line (one way) length		m	Max.100			
Vertical height differences	Outdoor is higher/lower	m	Max.50 / Max.15			
Outdoor operating temperature range	Cooling	°CDB	-15~50*3			
	Heating	°CWB	-20~20			
Air filter (option)			Filter kit : UM-FL1EF	Filter kit : UM-FL2EF	Filter kit : UM-FL1EF	
Remote control (option)			wired:RC-EX3A, RC-E5, RCH-E3 wireless:RCN-KIT4-E2			

R410A			Hyper Inverter			
Set model name			FDUM40ZSXVH	FDUM50ZSXVH	FDUM60ZSXVH	
Indoor unit			FDUM40VH	FDUM50VH	FDUM60VH	
Outdoor unit			SRC40ZSX-S	SRC50ZSX-S	SRC60ZSX-S	
Power source			1 Phase 220-240V, 50Hz / 220V, 60Hz			
Nominal cooling capacity (Min~Max)	kW		4.0 ( 1.1 ~ 4.7 )	5.0 ( 1.1 ~ 5.6 )	5.6 ( 1.1 ~ 6.3 )	
Nominal heating capacity (Min~Max)	kW		4.5 ( 0.6 ~ 5.4 )	5.4 ( 0.6 ~ 6.3 )	6.7 ( 0.6 ~ 7.1 )	
Power consumption	Cooling/Heating	kW	0.952 / 1.07	1.38 / 1.45	1.54 / 1.75	
EER/COP	Cooling/Heating		4.20 / 4.21	3.62 / 3.72	3.64 / 3.83	
Inrush current		A	5	5	5	
Max. current			12	15	15	
Sound power level*1	Indoor	Cooling/Heating	60 / 60	60 / 60	60 / 60	
	Outdoor	Cooling/Heating	63 / 63	63 / 63	65 / 64	
Sound pressure level*1	Indoor	Cooling (P-Hi/Hi/Me/Lo)	37 / 32 / 29 / 26	37 / 32 / 29 / 26	36 / 31 / 28 / 25	
		Heating (P-Hi/Hi/Me/Lo)	37 / 32 / 29 / 26	37 / 32 / 29 / 26	36 / 31 / 28 / 25	
	Outdoor	Cooling/Heating	50 / 49	50 / 49	52 / 52	
Air flow	Indoor	Cooling (P-Hi/Hi/Me/Lo)	13 / 10 / 9 / 8	13 / 10 / 9 / 8	20 / 15 / 13 / 10	
		Heating (P-Hi/Hi/Me/Lo)	13 / 10 / 9 / 8	13 / 10 / 9 / 8	20 / 15 / 13 / 10	
	Outdoor	Cooling/Heating	36 / 33	40 / 33	41.5 / 39	
External static pressure*2		Pa	Standard:35 Max:100			
Exterior dimensions	Indoor	HeightxWidthxDepth	mm	280 x 750 x 635		280 x 950 x 635
	Outdoor		mm	640 x 800(+71) x 290		
Net weight	Indoor		kg	29		34
	Outdoor		kg	45		
Ref.piping size	Liquid/Gas	ømm	6.35(1/4") / 12.7(1/2")			
Refrigerant line (one way) length		m	Max.30			
Vertical height differences	Outdoor is higher/lower	m	Max.20 / Max.20			
Outdoor operating temperature range	Cooling	°CDB	-15~46*3			
	Heating	°CWB	-20~20			
Air filter (option)			Filter kit : UM-FL1EF		Filter kit : UM-FL2EF	
Remote control (option)			wired:RC-EX3A, RC-E5, RCH-E3 wireless:RCN-KIT4-E2			

## SPECIFICATIONS - FDUM -

R410A		Hyper Inverter				
Set model name		FDUM71VNXVH	FDUM100VNXVH	FDUM125VNXVH	FDUM140VNXVH	
Indoor unit		FDUM71VH	FDUM100VH	FDUM125VH	FDUM140VH	
Outdoor unit		FDC71VNX	FDC100VNX	FDC125VNX	FDC140VNX	
Power source		1 Phase 220-240V, 50Hz / 220V, 60Hz				
Nominal cooling capacity (Min-Max)		kW 7.1 (3.2 ~ 8.0)	10.0 (4.0 ~ 11.2)	12.5 (5.0 ~ 14.0)	14.0 (5.0 ~ 16.0)	
Nominal heating capacity (Min-Max)		kW 8.0 (3.6 ~ 9.0)	11.2 (4.0 ~ 12.5)	14.0 (4.0 ~ 17.0)	16.0 (4.0 ~ 18.0)	
Power consumption	Cooling/Heating	kW 2.03 / 1.99	2.68 / 3.02	3.49 / 3.77	4.28 / 4.42	
EER/COP	Cooling/Heating	3.50 / 4.02	3.73 / 3.71	3.58 / 3.71	3.27 / 3.62	
Inrush current		A 5	5	5	5	
Max. current		17	24	26	26	
Sound power level*1	Indoor	Cooling/Heating	65 / 65	65 / 65	67 / 67	70 / 70
	Outdoor	Cooling/Heating	66 / 66	70 / 70	70 / 70	72 / 72
Sound pressure level*1	Indoor	Cooling (P-Hi/Hi/Me/Lo)	dB(A) 38 / 33 / 29 / 25	44 / 38 / 36 / 30	45 / 40 / 34 / 29	47 / 40 / 35 / 30
		Heating (P-Hi/Hi/Me/Lo)	38 / 33 / 29 / 25	44 / 38 / 36 / 30	45 / 40 / 34 / 29	47 / 40 / 35 / 30
Air flow	Indoor	Cooling (P-Hi/Hi/Me/Lo)	m <sup>3</sup> /min 24 / 19 / 15 / 10	36 / 28 / 25 / 19	39 / 32 / 26 / 20	48 / 35 / 28 / 22
		Heating (P-Hi/Hi/Me/Lo)	24 / 19 / 15 / 10	36 / 28 / 25 / 19	39 / 32 / 26 / 20	48 / 35 / 28 / 22
Outdoor	Cooling/Heating	60 / 50	100 / 100	100 / 100	100 / 100	
External static pressure*2		Pa Standard:35 Max:100	Standard:60 Max:100			
Exterior dimensions	Indoor	HeightxWidthxDepth	mm 280 x 950 x 635			
	Outdoor		750 x 880(+88) x 340			
Net weight	Indoor		kg 34			
	Outdoor		60			
Ref.piping size	Liquid/Gas	ømm 9.52(3/8") / 15.88(5/8")				
Refrigerant line (one way) length		m Max.50	Max.100			
Vertical height differences		Outdoor is higher/lower	m Max.30 / Max.15			
Outdoor operating temperature range	Cooling	°CDB -15~43*3				
	Heating	°CWB -20~20				
Air filter (option)		Filter kit : UM-FL2EF	Filter kit : UM-FL3EF			
Remote control (option)		wired:RC-EX3A, RC-E5, RCH-E3 wireless:RCN-KIT4-E2				

R410A		Hyper Inverter			
Set model name		FDUM100VSXVH	FDUM125VSXVH	FDUM140VSXVH	
Indoor unit		FDUM100VH	FDUM125VH	FDUM140VH	
Outdoor unit		FDC100VSX	FDC125VSX	FDC140VSX	
Power source		3 Phase 380-415V, 50Hz / 380V, 60Hz			
Nominal cooling capacity (Min-Max)		kW 10.0 (4.0 ~ 11.2)	12.5 (5.0 ~ 14.0)	14.0 (5.0 ~ 16.0)	
Nominal heating capacity (Min-Max)		kW 11.2 (4.0 ~ 16.0)	14.0 (4.0 ~ 18.0)	16.0 (4.0 ~ 20.0)	
Power consumption	Cooling/Heating	kW 2.68 / 3.02	3.49 / 3.77	4.28 / 4.42	
EER/COP	Cooling/Heating	3.73 / 3.71	3.58 / 3.71	3.27 / 3.62	
Inrush current		A 5	5	5	
Max. current		15	15	15	
Sound power level*1	Indoor	Cooling/Heating	65 / 65	67 / 67	70 / 70
	Outdoor	Cooling/Heating	70 / 70	70 / 70	72 / 72
Sound pressure level*1	Indoor	Cooling (P-Hi/Hi/Me/Lo)	dB(A) 44 / 38 / 36 / 30	45 / 40 / 34 / 29	47 / 40 / 35 / 30
		Heating (P-Hi/Hi/Me/Lo)	44 / 38 / 36 / 30	45 / 40 / 34 / 29	47 / 40 / 35 / 30
Air flow	Indoor	Cooling (P-Hi/Hi/Me/Lo)	m <sup>3</sup> /min 36 / 28 / 25 / 19	39 / 32 / 26 / 20	48 / 35 / 28 / 22
		Heating (P-Hi/Hi/Me/Lo)	36 / 28 / 25 / 19	39 / 32 / 26 / 20	48 / 35 / 28 / 22
Outdoor	Cooling/Heating	100 / 100	100 / 100	100 / 100	
External static pressure*2		Pa Standard:60 Max:100	Standard:60 Max:100		
Exterior dimensions	Indoor	HeightxWidthxDepth	mm 280 x 1,370 x 740		
	Outdoor		1,300 x 970 x 370		
Net weight	Indoor		kg 54		
	Outdoor		105		
Ref.piping size	Liquid/Gas	ømm 9.52(3/8") / 15.88(5/8")			
Refrigerant line (one way) length		m Max.100	Max.100		
Vertical height differences		Outdoor is higher/lower	m Max.30 / Max.15		
Outdoor operating temperature range	Cooling	°CDB -15~43*3			
	Heating	°CWB -20~20			
Air filter (option)		Filter kit : UM-FL3EF			
Remote control (option)		wired:RC-EX3A, RC-E5, RCH-E3 wireless:RCN-KIT4-E2			

### NOTES:

- The data are measured under the following conditions(ISO-T1).  
Cooling:Indoor temp. of 27°CDB, 19°CWB, and outdoor temp. of 35°CDB. Heating:Indoor temp. of 20°CDB, and outdoor temp. of 7°CDB, 6°CWB.
- \*1 : Indicates the value in an anechoic chamber. During operation these values are somewhat higher due to ambient conditions.
- \*2 : External static pressure is changeable to be set by the remote control. MAX external static pressure is "High static pressure" setting. The values of sound pressure level become 5dB(A) higher at external static pressure of 100Pa.
- \*3 : If a cooling operation is conducted when the outdoor air temperature is -5°C or lower, the outdoor unit should be installed at a place where it is not influenced by natural wind. If wind blows, the low pressure will drop and compressor frequency will increase, this will cause the capacity to drop and may cause the unit to break down.
- \*4 : The values are for one indoor unit operation. (Multi system only)

The values are for simultaneous Multi operation.

R410A		Hyper Inverter				
Set model name		FDUM71VNXPVH	FDUM100VNXPVH	FDUM125VNXPVH	FDUM140VNXPVH	FDUM140VNXTVH
		Twin			Triple	
Indoor unit		FDUM40VH x 2	FDUM50VH x 2	FDUM60VH x 2	FDUM71VH x 2	FDUM50VH x 3
Outdoor unit		FDC71VNX	FDC100VNX	FDC125VNX	FDC140VNX	FDC140VNX
Power source		1 Phase 220-240V, 50Hz / 220V, 60Hz				
Nominal cooling capacity (Min~Max)	kW	7.1 (3.2 ~ 8.0)	10.0 (4.0 ~ 11.2)	12.5 (5.0 ~ 14.0)	14.0 (5.0 ~ 16.0)	14.0 (5.0 ~ 16.0)
Nominal heating capacity (Min~Max)	kW	8.0 (3.6 ~ 9.0)	11.2 (4.0 ~ 12.5)	14.0 (4.0 ~ 17.0)	16.0 (4.0 ~ 18.0)	16.0 (4.0 ~ 18.0)
Power consumption	Cooling/Heating kW	2.01 / 1.91	2.66 / 3.02	3.26 / 3.66	4.36 / 4.35	4.21 / 4.69
EER/COP	Cooling/Heating	3.53 / 4.19	3.76 / 3.71	3.83 / 3.83	3.21 / 3.68	3.33 / 3.41
Inrush current	A	5	5	5	5	5
Max. current		17	24	26	26	26
Sound power level*1	Indoor*4	Cooling/Heating	60 / 60	60 / 60	60 / 60	65 / 65
	Outdoor	Cooling/Heating	66 / 66	70 / 70	70 / 70	72 / 72
Sound pressure level*1	Indoor*4	Cooling (P-Hi/Hi/Me/Lo)	37 / 32 / 29 / 26	37 / 32 / 29 / 26	36 / 31 / 28 / 25	38 / 33 / 29 / 25
	Outdoor	Heating (P-Hi/Hi/Me/Lo)	37 / 32 / 29 / 26	37 / 32 / 29 / 26	36 / 31 / 28 / 25	38 / 33 / 29 / 25
Air flow	Indoor*4	Cooling/Heating	51 / 48	48 / 50	48 / 50	49 / 52
	Outdoor	Cooling/Heating	13 / 10 / 9 / 8	13 / 10 / 9 / 8	20 / 15 / 13 / 10	24 / 19 / 15 / 10
External static pressure*2	Indoor*4	Cooling (P-Hi/Hi/Me/Lo)	13 / 10 / 9 / 8	13 / 10 / 9 / 8	20 / 15 / 13 / 10	24 / 19 / 15 / 10
	Outdoor	Heating (P-Hi/Hi/Me/Lo)	13 / 10 / 9 / 8	13 / 10 / 9 / 8	20 / 15 / 13 / 10	24 / 19 / 15 / 10
Exterior dimensions	Indoor	HeightxWidthxDpeth	Standard:35 Max:100			
	Outdoor	mm	280 x 750 x 635	280 x 950 x 635	280 x 950 x 635	280 x 750 x 635
Net weight	Indoor	kg	29		34	29
	Outdoor	kg	60		105	
Ref.piping size	Liquid/Gas	ømm	9.52(3/8") / 15.88(5/8")			
Refrigerant line (one way) length	m	Max.50	Max.100			
Vertical height differences	Outdoor is higher/lower	m	Max.30 / Max.15			
Outdoor operating temperature range	Cooling	°CDB	-15~43*3			
	Heating	°CWB	-20~20			
Air filter (option)		Filter kit : UM-FL1EF		Filter kit : UM-FL2EF	Filter kit : UM-FL1EF	
Remote control (option)		wired:RC-EX3A, RC-E5, RCH-E3 wireless:RCN-KIT4-E2				

The values are for simultaneous Multi operation.

R410A		Hyper Inverter				
Set model name		FDUM100VSPXVH	FDUM125VSPXVH	FDUM140VSPXVH	FDUM140VVSXTVH	
		Twin			Triple	
Indoor unit		FDUM50VH x 2	FDUM60VH x 2	FDUM71VH x 2	FDUM50VH x 3	
Outdoor unit		FDC100VVSX	FDC125VVSX	FDC140VVSX	FDC140VVSX	
Power source		3 Phase 380-415V, 50Hz / 380V, 60Hz				
Nominal cooling capacity (Min~Max)	kW	10.0 (4.0 ~ 11.2)	12.5 (5.0 ~ 14.0)	14.0 (5.0 ~ 16.0)	14.0 (5.0 ~ 16.0)	
Nominal heating capacity (Min~Max)	kW	11.2 (4.0 ~ 16.0)	14.0 (4.0 ~ 18.0)	16.0 (4.0 ~ 20.0)	16.0 (4.0 ~ 20.0)	
Power consumption	Cooling/Heating kW	2.66 / 3.02	3.26 / 3.66	4.36 / 4.35	4.21 / 4.69	
EER/COP	Cooling/Heating	3.76 / 3.71	3.83 / 3.83	3.21 / 3.68	3.33 / 3.41	
Inrush current	A	5	5	5	5	
Max. current		15	15	15	15	
Sound power level*1	Indoor*4	Cooling/Heating	60 / 60	60 / 60	65 / 65	
	Outdoor	Cooling/Heating	70 / 70	70 / 70	72 / 72	
Sound pressure level*1	Indoor*4	Cooling (P-Hi/Hi/Me/Lo)	37 / 32 / 29 / 26	36 / 31 / 28 / 25	38 / 33 / 29 / 25	
	Outdoor	Heating (P-Hi/Hi/Me/Lo)	37 / 32 / 29 / 26	36 / 31 / 28 / 25	38 / 33 / 29 / 25	
Air flow	Indoor*4	Cooling/Heating	48 / 50	48 / 50	49 / 52	
	Outdoor	Cooling/Heating	13 / 10 / 9 / 8	20 / 15 / 13 / 10	24 / 19 / 15 / 10	
External static pressure*2	Indoor*4	Cooling (P-Hi/Hi/Me/Lo)	13 / 10 / 9 / 8	20 / 15 / 13 / 10	24 / 19 / 15 / 10	
	Outdoor	Heating (P-Hi/Hi/Me/Lo)	13 / 10 / 9 / 8	20 / 15 / 13 / 10	24 / 19 / 15 / 10	
Exterior dimensions	Indoor	HeightxWidthxDpeth	Standard:35 Max:100			
	Outdoor	mm	280 x 750 x 635	280 x 950 x 635	280 x 950 x 635	
Net weight	Indoor	kg	29		34	
	Outdoor	kg	60		105	
Ref.piping size	Liquid/Gas	ømm	9.52(3/8") / 15.88(5/8")			
Refrigerant line (one way) length	m	Max.50	Max.100			
Vertical height differences	Outdoor is higher/lower	m	Max.30 / Max.15			
Outdoor operating temperature range	Cooling	°CDB	-15~43*3			
	Heating	°CWB	-20~20			
Air filter (option)		Filter kit : UM-FL1EF		Filter kit : UM-FL2EF	Filter kit : UM-FL1EF	
Remote control (option)		wired:RC-EX3A, RC-E5, RCH-E3 wireless:RCN-KIT4-E2				

## SPECIFICATIONS - FDUM -

R32			Micro Inverter		
Set model name			FDUM100VNAWVH	FDUM125VNAWVH	FDUM140VNAWVH
Indoor unit			FDUM100VH	FDUM125VH	FDUM140VH
Outdoor unit			FDC100VNA-W	FDC125VNA-W	FDC140VNA-W
Power source			1 Phase 220-240V, 50Hz / 220V, 60Hz		
Nominal cooling capacity (Min-Max)			10.0 ( 4.0 ~ 11.2 )	12.5 ( 5.0 ~ 14.0 )	13.6 ( 5.0 ~ 14.5 )
Nominal heating capacity (Min-Max)			11.2 ( 4.0 ~ 12.5 )	14.0 ( 4.0 ~ 16.0 )	15.5 ( 4.0 ~ 16.5 )
Power consumption			2.99 / 2.66	4.36 / 3.69	5.13 / 4.21
EER/COP			3.35 / 4.21	2.87 / 3.79	2.65 / 3.68
Inrush current			5	5	5
Max. current			26	26	27
Sound power level*1	Indoor	Cooling/Heating	65 / 65	67 / 67	70 / 70
	Outdoor	Cooling/Heating	69 / 70	71 / 71	72 / 73
Sound pressure level*1	Indoor	Cooling (P-Hi/Hi/Me/Lo)	44 / 38 / 36 / 30	45 / 40 / 34 / 29	47 / 40 / 35 / 30
		Heating (P-Hi/Hi/Me/Lo)	44 / 38 / 36 / 30	45 / 40 / 34 / 29	47 / 40 / 35 / 30
Air flow	Indoor	Cooling (P-Hi/Hi/Me/Lo)	36 / 28 / 25 / 19	39 / 32 / 26 / 20	48 / 35 / 28 / 22
		Heating (P-Hi/Hi/Me/Lo)	36 / 28 / 25 / 19	39 / 32 / 26 / 20	48 / 35 / 28 / 22
Air flow	Outdoor	Cooling/Heating	75 / 73	75 / 73	75 / 73
		Cooling/Heating	75 / 73	75 / 73	75 / 73
External static pressure*2			Standard:60 Max:100		
Exterior dimensions	Indoor	HeightxWidthxDepth	280 x 1,370 x 740		
	Outdoor		845 x 970 x 370		
Net weight	Indoor		54		
	Outdoor		77		
Ref.piping size			Liquid/Gas ømm 9.52(3/8") / 15.88(5/8")		
Refrigerant line (one way) length			m Max.50		
Vertical height differences			Outdoor is higher/lower m Max.50 / Max.15		
Outdoor operating temperature range			Cooling	°CDB -15~50*3	
			Heating	°CWB -20~20	
Air filter (option)			Filter kit : UM-FL3EF		
Remote control (option)			wired:RC-EX3A, RC-E5, RCH-E3 wireless:RCN-KIT4-E2		

R32			Micro Inverter		
Set model name			FDUM100VSAWVH	FDUM125VSAWVH	FDUM140VSAWVH
Indoor unit			FDUM100VH	FDUM125VH	FDUM140VH
Outdoor unit			FDC100VSA-W	FDC125VSA-W	FDC140VSA-W
Power source			3 Phase 380-415V, 50Hz / 380V, 60Hz		
Nominal cooling capacity (Min-Max)			10.0 ( 4.0 ~ 11.2 )	12.5 ( 5.0 ~ 14.0 )	13.6 ( 5.0 ~ 14.5 )
Nominal heating capacity (Min-Max)			11.2 ( 4.0 ~ 12.5 )	14.0 ( 4.0 ~ 16.0 )	15.5 ( 4.0 ~ 16.5 )
Power consumption			2.99 / 2.66	4.36 / 3.69	5.13 / 4.21
EER/COP			3.35 / 4.21	2.87 / 3.79	2.65 / 3.68
Inrush current			5	5	5
Max. current			17	17	18
Sound power level*1	Indoor	Cooling/Heating	65 / 65	67 / 67	70 / 70
	Outdoor	Cooling/Heating	69 / 70	71 / 71	72 / 73
Sound pressure level*1	Indoor	Cooling (P-Hi/Hi/Me/Lo)	44 / 38 / 36 / 30	45 / 40 / 34 / 29	47 / 40 / 35 / 30
		Heating (P-Hi/Hi/Me/Lo)	44 / 38 / 36 / 30	45 / 40 / 34 / 29	47 / 40 / 35 / 30
Air flow	Indoor	Cooling (P-Hi/Hi/Me/Lo)	36 / 28 / 25 / 19	39 / 32 / 26 / 20	48 / 35 / 28 / 22
		Heating (P-Hi/Hi/Me/Lo)	36 / 28 / 25 / 19	39 / 32 / 26 / 20	48 / 35 / 28 / 22
Air flow	Outdoor	Cooling/Heating	75 / 73	75 / 73	75 / 73
		Cooling/Heating	75 / 73	75 / 73	75 / 73
External static pressure*2			Standard:60 Max:100		
Exterior dimensions	Indoor	HeightxWidthxDepth	280 x 1,370 x 740		
	Outdoor		845 x 970 x 370		
Net weight	Indoor		54		
	Outdoor		78		
Ref.piping size			Liquid/Gas ømm 9.52(3/8") / 15.88(5/8")		
Refrigerant line (one way) length			m Max.50		
Vertical height differences			Outdoor is higher/lower m Max.50 / Max.15		
Outdoor operating temperature range			Cooling	°CDB -15~50*3	
			Heating	°CWB -20~20	
Air filter (option)			Filter kit : UM-FL3EF		
Remote control (option)			wired:RC-EX3A, RC-E5, RCH-E3 wireless:RCN-KIT4-E2		

### NOTES:

- The data are measured under the following conditions(ISO-T1, -H1).  
Cooling:Indoor temp. of 27°CDB, 19°CWB, and outdoor temp. of 35°CDB. Heating:Indoor temp. of 20°CDB, and outdoor temp. of 7°CDB, 6°CWB.
- \*1 : Indicates the value in an anechoic chamber. During operation these values are somewhat higher due to ambient conditions.
  - \*2 : External static pressure is changeable to be set by the remote control. MAX external static pressure is "High static pressure" setting. The values of sound pressure level become 5dB(A) higher at external static pressure of 100Pa.
  - \*3 : If a cooling operation is conducted when the outdoor air temperature is -5°C or lower, the outdoor unit should be installed at a place where it is not influenced by natural wind. If wind blows, the low pressure will drop and compressor frequency will increase, this will cause the capacity to drop and may cause the unit to break down.
  - \*4 : The values are for one indoor unit operation. (Multi system only)

The values are for simultaneous Multi operation.

R32		Micro Inverter				
Set model name		FDUM100VNAWPVH	FDUM125VNAWPVH	FDUM140VNAWPVH	FDUM140VNAWTVH	
		Twin		Triple		
Indoor unit		FDUM50VH x 2	FDUM60VH x 2	FDUM71VH x 2	FDUM50VH x 3	
Outdoor unit		FDC100VNA-W	FDC125VNA-W	FDC140VNA-W	FDC140VNA-W	
Power source		1 Phase 220-240V, 50Hz / 220V, 60Hz				
Nominal cooling capacity (Min~Max)	kW	10.0 ( 4.0 ~ 11.2 )	12.5 ( 5.0 ~ 14.0 )	13.6 ( 5.0 ~ 14.5 )	13.6 ( 5.0 ~ 14.5 )	
Nominal heating capacity (Min~Max)	kW	11.2 ( 4.0 ~ 12.5 )	14.0 ( 4.0 ~ 16.0 )	15.5 ( 4.0 ~ 16.5 )	15.5 ( 4.0 ~ 16.5 )	
Power consumption	Cooling/Heating kW	3.25 / 3.04	4.53 / 3.52	5.02 / 4.20	5.02 / 4.20	
EER/COP	Cooling/Heating	3.08 / 3.68	2.76 / 3.98	2.71 / 3.69	2.71 / 3.69	
Inrush current	A	5	5	5	5	
Max. current		26	26	27	27	
Sound power level*1	Indoor*4	Cooling/Heating	60 / 60	60 / 60	65 / 65	60 / 60
	Outdoor	Cooling/Heating	69 / 70	71 / 71	72 / 73	72 / 73
Sound pressure level*1	Indoor*4	Cooling (P-Hi/Hi/Me/Lo)	37 / 32 / 29 / 26	36 / 31 / 28 / 25	38 / 33 / 29 / 25	37 / 32 / 29 / 26
		Heating (P-Hi/Hi/Me/Lo)	37 / 32 / 29 / 26	36 / 31 / 28 / 25	38 / 33 / 29 / 25	37 / 32 / 29 / 26
Air flow	Outdoor	Cooling/Heating	54 / 55	54 / 56	56 / 58	56 / 58
		Cooling (P-Hi/Hi/Me/Lo)	13 / 10 / 9 / 8	20 / 15 / 13 / 10	24 / 19 / 15 / 10	13 / 10 / 9 / 8
Air flow	Outdoor	Heating (P-Hi/Hi/Me/Lo)	13 / 10 / 9 / 8	20 / 15 / 13 / 10	24 / 19 / 15 / 10	13 / 10 / 9 / 8
		Cooling/Heating	75 / 73	75 / 73	75 / 73	75 / 73
External static pressure*2	Pa	Standard:35 Max:100				
Exterior dimensions	Indoor	HeightxWidthxDepth	mm	280 x 750 x 635	280 x 950 x 635	280 x 750 x 635
	Outdoor		845 x 970 x 370			
Net weight	Indoor		kg	29	34	29
	Outdoor		77			
Ref.piping size	Liquid/Gas	ømm	9.52(3/8") / 15.88(5/8")			
Refrigerant line (one way) length		m	Max.50			
Vertical height differences	Outdoor is higher/lower	m	Max.50 / Max.15			
Outdoor operating temperature range	Cooling	°CDB	-15~50*3			
	Heating	°CWB	-20~20			
Air filter (option)			Filter kit : UM-FL1EF	Filter kit : UM-FL2EF	Filter kit : UM-FL1EF	
Remote control (option)			wired:RC-EX3A, RC-E5, RCH-E3 wireless:RCN-KIT4-E2			

The values are for simultaneous Multi operation.

R32		Micro Inverter				
Set model name		FDUM100VSAWPVH	FDUM125VSAWPVH	FDUM140VSAWPVH	FDUM140VSAWTVH	
		Twin		Triple		
Indoor unit		FDUM50VH x 2	FDUM60VH x 2	FDUM71VH x 2	FDUM50VH x 3	
Outdoor unit		FDC100VSA-W	FDC125VSA-W	FDC140VSA-W	FDC140VSA-W	
Power source		3 Phase 380-415V, 50Hz / 380V, 60Hz				
Nominal cooling capacity (Min~Max)	kW	10.0 ( 4.0 ~ 11.2 )	12.5 ( 5.0 ~ 14.0 )	13.6 ( 5.0 ~ 14.5 )	13.6 ( 5.0 ~ 14.5 )	
Nominal heating capacity (Min~Max)	kW	11.2 ( 4.0 ~ 12.5 )	14.0 ( 4.0 ~ 16.0 )	15.5 ( 4.0 ~ 16.5 )	15.5 ( 4.0 ~ 16.5 )	
Power consumption	Cooling/Heating kW	3.25 / 3.04	4.53 / 3.52	5.02 / 4.20	5.02 / 4.20	
EER/COP	Cooling/Heating	3.08 / 3.68	2.76 / 3.98	2.71 / 3.69	2.71 / 3.69	
Inrush current	A	5	5	5	5	
Max. current		17	17	18	18	
Sound power level*1	Indoor*4	Cooling/Heating	60 / 60	60 / 60	65 / 65	60 / 60
	Outdoor	Cooling/Heating	69 / 70	71 / 71	72 / 73	72 / 73
Sound pressure level*1	Indoor*4	Cooling (P-Hi/Hi/Me/Lo)	37 / 32 / 29 / 26	36 / 31 / 28 / 25	38 / 33 / 29 / 25	37 / 32 / 29 / 26
		Heating (P-Hi/Hi/Me/Lo)	37 / 32 / 29 / 26	36 / 31 / 28 / 25	38 / 33 / 29 / 25	37 / 32 / 29 / 26
Air flow	Outdoor	Cooling/Heating	54 / 55	54 / 56	56 / 58	56 / 58
		Cooling (P-Hi/Hi/Me/Lo)	13 / 10 / 9 / 8	20 / 15 / 13 / 10	24 / 19 / 15 / 10	13 / 10 / 9 / 8
Air flow	Outdoor	Heating (P-Hi/Hi/Me/Lo)	13 / 10 / 9 / 8	20 / 15 / 13 / 10	24 / 19 / 15 / 10	13 / 10 / 9 / 8
		Cooling/Heating	75 / 73	75 / 73	75 / 73	75 / 73
External static pressure*2	Pa	Standard:35 Max:100				
Exterior dimensions	Indoor	HeightxWidthxDepth	mm	280 x 750 x 635	280 x 950 x 635	280 x 750 x 635
	Outdoor		845 x 970 x 370			
Net weight	Indoor		kg	29	34	29
	Outdoor		78			
Ref.piping size	Liquid/Gas	ømm	9.52(3/8") / 15.88(5/8")			
Refrigerant line (one way) length		m	Max.50			
Vertical height differences	Outdoor is higher/lower	m	Max.50 / Max.15			
Outdoor operating temperature range	Cooling	°CDB	-15~50*3			
	Heating	°CWB	-20~20			
Air filter (option)			Filter kit : UM-FL1EF	Filter kit : UM-FL2EF	Filter kit : UM-FL1EF	
Remote control (option)			wired:RC-EX3A, RC-E5, RCH-E3 wireless:RCN-KIT4-E2			

## SPECIFICATIONS - FDUM -

The values are for simultaneous Multi operation.

R32		Micro Inverter				
Set model name		FDUM200VSAWPVH	FDUM250VSAWPVH	FDUM280VSAWPVH	FDUM200VSAWTVH	
		Twin		Triple		
Indoor unit		FDUM100VH x 2	FDUM125VH x 2	FDUM140VH x 2	FDUM71VH x 3	
Outdoor unit		FDC200VSA-W	FDC250VSA-W	FDC280VSA-W	FDC200VSA-W	
Power source		3 Phase 380-415V, 50Hz / 380V, 60Hz				
Nominal cooling capacity (Min~Max)	kW	20.0 ( 6.8 ~ 22.4 )	25.0 ( 6.8 ~ 28.0 )	27.0 ( 7.8 ~ 31.5 )	20.0 ( 6.8 ~ 22.4 )	
Nominal heating capacity (Min~Max)	kW	22.4 ( 6.7 ~ 25.0 )	28.0 ( 5.2 ~ 31.5 )	30.0 ( 6.3 ~ 33.5 )	22.4 ( 6.7 ~ 25.0 )	
Power consumption	Cooling/Heating kW	6.58 / 5.59	8.74 / 7.90	10.05 / 8.47	6.58 / 5.59	
EER/COP	Cooling/Heating	3.04 / 4.01	2.86 / 3.54	2.69 / 3.54	3.04 / 4.01	
Inrush current		5	5	5	5	
Max. current		19	25	22	19	
Sound power level*1	Indoor*4	Cooling/Heating	65 / 65	67 / 67	70 / 70	65 / 65
	Outdoor	Cooling/Heating	72 / 74	73 / 75	75 / 77	72 / 74
Sound pressure level*1	Indoor*4	Cooling (P-Hi/Hi/Me/Lo)	44 / 38 / 36 / 30	45 / 40 / 34 / 29	47 / 40 / 35 / 30	38 / 33 / 29 / 25
	Outdoor	Heating (P-Hi/Hi/Me/Lo)	44 / 38 / 36 / 30	45 / 40 / 34 / 29	47 / 40 / 35 / 30	38 / 33 / 29 / 25
Air flow	Indoor*4	Cooling/Heating	58 / 59	58 / 62	61 / 63	58 / 59
	Outdoor	Cooling (P-Hi/Hi/Me/Lo)	36 / 28 / 25 / 19	39 / 32 / 26 / 20	48 / 35 / 28 / 22	24 / 19 / 15 / 10
		Heating (P-Hi/Hi/Me/Lo)	36 / 28 / 25 / 19	39 / 32 / 26 / 20	48 / 35 / 28 / 22	24 / 19 / 15 / 10
		Cooling/Heating	148 / 134	148 / 153	136 / 140	148 / 134
External static pressure*2	Pa	Standard:60 Max:100			Standard:35 Max:100	
Exterior dimensions	Indoor	HeightxWidthxDepth	280 x 1,370 x 740		280 x 950 x 635	
	Outdoor		1,505 x 970 x 370			
Net weight	Indoor		54		34	
	Outdoor		144	145	155	
Ref.piping size	Liquid/Gas	ømm	9.52(3/8") / 22.22(7/8")	12.7(1/2") / 22.22(7/8")	9.52(3/8") / 22.22(7/8")	
Refrigerant line (one way) length		m	Max.70		Max.60	
Vertical height differences	Outdoor is higher/lower	m	Max.50*5 / Max.15			
Outdoor operating temperature range	Cooling	°CDB	-15~50*3			
	Heating	°CWB	-20~20			
Air filter (option)			Filter kit : UM-FL3EF		Filter kit : UM-FL2EF	
Remote control (option)			wired:RC-EX3A, RC-E5, RCH-E3 wireless:RCN-KIT4-E2			

R410A		Micro Inverter			
Set model name		FDUM100VNAVH	FDUM125VNAVH	FDUM140VNAVH	
Indoor unit		FDUM100VH	FDUM125VH	FDUM140VH	
Outdoor unit		FDC100VNA	FDC125VNA	FDC140VNA	
Power source		1 Phase 220-240V, 50Hz / 220V, 60Hz			
Nominal cooling capacity (Min~Max)	kW	10.0 ( 4.0 ~ 11.2 )	12.5 ( 5.0 ~ 14.0 )	13.6 ( 5.0 ~ 14.5 )	
Nominal heating capacity (Min~Max)	kW	11.2 ( 4.0 ~ 12.5 )	14.0 ( 4.0 ~ 16.0 )	15.5 ( 4.0 ~ 16.5 )	
Power consumption	Cooling/Heating kW	2.84 / 2.78	4.36 / 3.69	4.93 / 4.21	
EER/COP	Cooling/Heating	3.52 / 4.03	2.87 / 3.79	2.76 / 3.68	
Inrush current		5	5	5	
Max. current		26	26	27	
Sound power level*1	Indoor	Cooling/Heating	65 / 65	67 / 67	70 / 70
	Outdoor	Cooling/Heating	70 / 70	71 / 71	73 / 73
Sound pressure level*1	Indoor	Cooling (P-Hi/Hi/Me/Lo)	44 / 38 / 36 / 30	45 / 40 / 34 / 29	47 / 40 / 35 / 30
	Outdoor	Heating (P-Hi/Hi/Me/Lo)	44 / 38 / 36 / 30	45 / 40 / 34 / 29	47 / 40 / 35 / 30
Air flow	Indoor	Cooling/Heating	54 / 56	55 / 57	57 / 59
	Outdoor	Cooling (P-Hi/Hi/Me/Lo)	36 / 28 / 25 / 19	39 / 32 / 26 / 20	48 / 35 / 28 / 22
		Heating (P-Hi/Hi/Me/Lo)	36 / 28 / 25 / 19	39 / 32 / 26 / 20	48 / 35 / 28 / 22
		Cooling/Heating	75 / 73	75 / 73	75 / 73
External static pressure*2	Pa	Standard:60 Max:100			
Exterior dimensions	Indoor	HeightxWidthxDepth	280 x 1,370 x 740		845 x 970 x 370
	Outdoor		845 x 970 x 370		
Net weight	Indoor		54		80
	Outdoor		80		
Ref.piping size	Liquid/Gas	ømm	9.52(3/8") / 15.88(5/8")		
Refrigerant line (one way) length		m	Max.50		
Vertical height differences	Outdoor is higher/lower	m	Max.50 / Max.15		
Outdoor operating temperature range	Cooling	°CDB	-15~50*3		
	Heating	°CWB	-20~20		
Air filter (option)			Filter kit : UM-FL3EF		
Remote control (option)			wired:RC-EX3A, RC-E5, RCH-E3 wireless:RCN-KIT4-E2		

### NOTES:

<p>The data are measured under the following conditions(R32 : ISO-T1, -H1 / R410A : ISO-T1).  Cooling:Indoor temp. of 27°CDB, 19°CWB, and outdoor temp. of 35°CDB. Heating:Indoor temp. of 20°CDB, and outdoor temp. of 7°CDB, 6°CWB.  *1 : Indicates the value in an anechoic chamber. During operation these values are somewhat higher due to ambient conditions.  *2 : External static pressure is changeable to be set by the remote control. MAX external static pressure is "High static pressure" setting. The values of sound pressure level become 5dB(A) higher at external static pressure of 100Pa.  *3 : If a cooling operation is conducted when the outdoor air temperature is -5°C or lower, the outdoor unit should be installed at a place where it is not influenced by natural wind. If wind blows, the low pressure will drop and compressor frequency will increase, this will cause the capacity to drop and may cause the unit to break down.  *4 : The values are for one indoor unit operation. (Multi system only)  *5 : In case of following conditions:Max.50m(Outdoor unit is higher &amp; Outdoor temperature ≤ 43°C), Max.30m(Outdoor unit is higher &amp; Outdoor temperature &gt; 43°C)</p>
--

R410A		Micro Inverter			
Set model name		FDUM100VSAVH	FDUM125VSAVH	FDUM140VSAVH	
Indoor unit		FDUM100VH	FDUM125VH	FDUM140VH	
Outdoor unit		FDC100VSA	FDC125VSA	FDC140VSA	
Power source		3 Phase 380-415V, 50Hz / 380V, 60Hz			
Nominal cooling capacity (Min~Max)	kW	10.0 ( 4.0 ~ 11.2 )	12.5 ( 5.0 ~ 14.0 )	13.6 ( 5.0 ~ 14.5 )	
Nominal heating capacity (Min~Max)	kW	11.2 ( 4.0 ~ 12.5 )	14.0 ( 4.0 ~ 16.0 )	15.5 ( 4.0 ~ 16.5 )	
Power consumption	Cooling/Heating kW	2.84 / 2.78	4.36 / 3.69	4.93 / 4.21	
EER/COP	Cooling/Heating	3.52 / 4.03	2.87 / 3.79	2.76 / 3.68	
Inrush current		5	5	5	
Max. current		17	17	18	
Sound power level*1	Indoor	Cooling/Heating	65 / 65	67 / 67	70 / 70
	Outdoor	Cooling/Heating	70 / 70	71 / 71	73 / 73
Sound pressure level*1	Indoor	Cooling (P-Hi/Hi/Me/Lo)	44 / 38 / 36 / 30	45 / 40 / 34 / 29	47 / 40 / 35 / 30
		Heating (P-Hi/Hi/Me/Lo)	44 / 38 / 36 / 30	45 / 40 / 34 / 29	47 / 40 / 35 / 30
	Outdoor	Cooling/Heating	54 / 56	55 / 57	57 / 59
		Cooling (P-Hi/Hi/Me/Lo)	36 / 28 / 25 / 19	39 / 32 / 26 / 20	48 / 35 / 28 / 22
Air flow	Indoor	Heating (P-Hi/Hi/Me/Lo)	36 / 28 / 25 / 19	39 / 32 / 26 / 20	48 / 35 / 28 / 22
		Cooling/Heating	75 / 73	75 / 73	75 / 73
	Outdoor	Cooling/Heating	75 / 73	75 / 73	75 / 73
External static pressure*2	Pa	Standard:60 Max:100			
Exterior dimensions	Indoor	HeightxWidthxDepth	280 x 1,370 x 740		
	Outdoor		845 x 970 x 370		
Net weight	Indoor		54		
	Outdoor		82		
Ref.piping size	Liquid/Gas	ømm 9.52(3/8") / 15.88(5/8")			
Refrigerant line (one way) length		m Max.50			
Vertical height differences	Outdoor is higher/lower	m Max.50 / Max.15			
Outdoor operating temperature range	Cooling	°CDB -15~50*3			
	Heating	°CWB -20~20			
Air filter (option)		Filter kit : UM-FL3EF			
Remote control (option)		wired:RC-EX3A, RC-E5, RCH-E3 wireless:RCN-KIT4-E2			

The values are for simultaneous Multi operation.

R410A		Micro Inverter			
Set model name		FDUM100VNAVH	FDUM125VNAVH	FDUM140VNAVH	FDUM140VNAVH
Indoor unit		FDUM50VH x 2	FDUM60VH x 2	FDUM71VH x 2	FDUM50VH x 3
Outdoor unit		FDC100VNA	FDC125VNA	FDC140VNA	FDC140VNA
Power source		1 Phase 220-240V, 50Hz / 220V, 60Hz			
Nominal cooling capacity (Min~Max)	kW	10.0 ( 4.0 ~ 11.2 )	12.5 ( 5.0 ~ 14.0 )	13.6 ( 5.0 ~ 14.5 )	13.6 ( 5.0 ~ 14.5 )
Nominal heating capacity (Min~Max)	kW	11.2 ( 4.0 ~ 12.5 )	14.0 ( 4.0 ~ 16.0 )	15.5 ( 4.0 ~ 16.5 )	15.5 ( 4.0 ~ 16.5 )
Power consumption	Cooling/Heating kW	3.25 / 3.21	4.53 / 3.75	5.02 / 4.20	5.02 / 4.20
EER/COP	Cooling/Heating	3.08 / 3.49	2.76 / 3.73	2.71 / 3.69	2.71 / 3.69
Inrush current		5	5	5	5
Max. current		26	26	27	27
Sound power level*1	Indoor*4	Cooling/Heating	60 / 60	60 / 60	65 / 65
	Outdoor	Cooling/Heating	70 / 70	71 / 71	73 / 73
Sound pressure level*1	Indoor*4	Cooling (P-Hi/Hi/Me/Lo)	37 / 32 / 29 / 26	36 / 31 / 28 / 25	38 / 33 / 29 / 25
		Heating (P-Hi/Hi/Me/Lo)	37 / 32 / 29 / 26	36 / 31 / 28 / 25	38 / 33 / 29 / 25
	Outdoor	Cooling/Heating	54 / 56	55 / 57	57 / 59
		Cooling (P-Hi/Hi/Me/Lo)	13 / 10 / 9 / 8	20 / 15 / 13 / 10	24 / 19 / 15 / 10
Air flow	Indoor*4	Heating (P-Hi/Hi/Me/Lo)	13 / 10 / 9 / 8	20 / 15 / 13 / 10	24 / 19 / 15 / 10
		Cooling/Heating	75 / 73	75 / 73	75 / 73
	Outdoor	Cooling/Heating	75 / 73	75 / 73	75 / 73
External static pressure*2	Pa	Standard:35 Max:100			
Exterior dimensions	Indoor	HeightxWidthxDepth	280 x 750 x 635		
	Outdoor		280 x 950 x 635		
Net weight	Indoor		29		
	Outdoor		80		
Ref.piping size	Liquid/Gas	ømm 9.52(3/8") / 15.88(5/8")			
Refrigerant line (one way) length		m Max.50			
Vertical height differences	Outdoor is higher/lower	m Max.50 / Max.15			
Outdoor operating temperature range	Cooling	°CDB -15~50*3			
	Heating	°CWB -20~20			
Air filter (option)		Filter kit : UM-FL1EF	Filter kit : UM-FL2EF	Filter kit : UM-FL1EF	
Remote control (option)		wired:RC-EX3A, RC-E5, RCH-E3 wireless:RCN-KIT4-E2			

# SPECIFICATIONS - FDUM -

The values are for simultaneous Multi operation.

R410A		Micro Inverter			
Set model name		FDUM100VSAPVH	FDUM125VSAPVH	FDUM140VSAPVH	FDUM140VSATVH
		Twin		Triple	
Indoor unit		FDUM50VH x 2	FDUM60VH x 2	FDUM71VH x 2	FDUM50VH x 3
Outdoor unit		FDC100VSA	FDC125VSA	FDC140VSA	FDC140VSA
Power source		3 Phase 380-415V, 50Hz / 380V, 60Hz			
Nominal cooling capacity (Min~Max)	kW	10.0 (4.0 ~ 11.2)	12.5 (5.0 ~ 14.0)	13.6 (5.0 ~ 14.5)	13.6 (5.0 ~ 14.5)
Nominal heating capacity (Min~Max)	kW	11.2 (4.0 ~ 12.5)	14.0 (4.0 ~ 16.0)	15.5 (4.0 ~ 16.5)	15.5 (4.0 ~ 16.5)
Power consumption	Cooling/Heating kW	3.25 / 3.21	4.53 / 3.75	5.02 / 4.20	5.02 / 4.20
EER/COP	Cooling/Heating	3.08 / 3.49	2.76 / 3.73	2.71 / 3.69	2.71 / 3.69
Inrush current	A	5	5	5	5
Max. current		17	17	18	18
Sound power level*1	Indoor*4	Cooling/Heating	60 / 60	60 / 60	65 / 65
	Outdoor	Cooling/Heating	70 / 70	71 / 71	73 / 73
Sound pressure level*1	Indoor*4	Cooling (P-Hi/Hi/Me/Lo)	37 / 32 / 29 / 26	36 / 31 / 28 / 25	38 / 33 / 29 / 25
	Outdoor	Heating (P-Hi/Hi/Me/Lo)	37 / 32 / 29 / 26	36 / 31 / 28 / 25	38 / 33 / 29 / 25
Air flow	Indoor*4	Cooling/Heating	54 / 56	55 / 57	57 / 59
	Outdoor	Cooling/Heating	13 / 10 / 9 / 8	20 / 15 / 13 / 10	24 / 19 / 15 / 10
External static pressure*2	Indoor	Cooling/Heating	13 / 10 / 9 / 8	20 / 15 / 13 / 10	24 / 19 / 15 / 10
	Outdoor	Cooling/Heating	13 / 10 / 9 / 8	20 / 15 / 13 / 10	24 / 19 / 15 / 10
Exterior dimensions	Indoor	HeightxWidthxDepth	75 / 73	75 / 73	75 / 73
	Outdoor	HeightxWidthxDepth	280 x 750 x 635	280 x 950 x 635	280 x 750 x 635
Net weight	Indoor		29	34	29
	Outdoor			82	
Ref.piping size	Liquid/Gas		9.52(3/8") / 15.88(5/8")		
Refrigerant line (one way) length			Max.50		
Vertical height differences	Outdoor is higher/lower		Max.50 / Max.15		
Outdoor operating temperature range	Cooling		-15~50*3		
	Heating		-20~20		
Air filter (option)		Filter kit : UM-FL1EF	Filter kit : UM-FL2EF	Filter kit : UM-FL1EF	
Remote control (option)		wired:RC-EX3A, RC-E5, RCH-E3 wireless:RCN-KIT4-E2			

The values are for simultaneous Multi operation.

R410A		Micro Inverter		
Set model name		FDUM200VSAPVH	FDUM250VSAPVH	FDUM200VSATVH
		Twin		Triple
Indoor unit		FDUM100VH x 2	FDUM125VH x 2	FDUM71VH x 3
Outdoor unit		FDC200VSA	FDC250VSA	FDC200VSA
Power source		3 Phase 380-415V, 50Hz / 380V, 60Hz		
Nominal cooling capacity (Min~Max)	kW	19.0 (5.2 ~ 22.4)	24.0 (6.9 ~ 28.0)	19.0 (5.2 ~ 22.4)
Nominal heating capacity (Min~Max)	kW	22.4 (3.3 ~ 25.0)	27.0 (5.5 ~ 31.5)	22.4 (3.3 ~ 25.0)
Power consumption	Cooling/Heating kW	6.51 / 6.04	8.33 / 7.52	6.46 / 6.15
EER/COP	Cooling/Heating	2.92 / 3.71	2.88 / 3.59	2.94 / 3.64
Inrush current	A	5	5	5
Max. current		22	24	22
Sound power level*1	Indoor*4	Cooling/Heating	65 / 65	67 / 67
	Outdoor	Cooling/Heating	72 / 74	73 / 75
Sound pressure level*1	Indoor*4	Cooling (P-Hi/Hi/Me/Lo)	44 / 38 / 36 / 30	45 / 40 / 34 / 29
	Outdoor	Heating (P-Hi/Hi/Me/Lo)	44 / 38 / 36 / 30	45 / 40 / 34 / 29
Air flow	Indoor*4	Cooling/Heating	58 / 59	59 / 62
	Outdoor	Cooling/Heating	36 / 28 / 25 / 19	39 / 32 / 26 / 20
External static pressure*2	Indoor	Cooling/Heating	36 / 28 / 25 / 19	39 / 32 / 26 / 20
	Outdoor	Cooling/Heating	36 / 28 / 25 / 19	39 / 32 / 26 / 20
Exterior dimensions	Indoor	HeightxWidthxDepth	135 / 135	143 / 151
	Outdoor	HeightxWidthxDepth	280 x 1,370 x 740	280 x 950 x 635
Net weight	Indoor		115	143
	Outdoor		54	34
Ref.piping size	Liquid/Gas		9.52(3/8") / 22.22(7/8")	
Refrigerant line (one way) length			Max.70	
Vertical height differences	Outdoor is higher/lower		Max.30 / Max.15	
Outdoor operating temperature range	Cooling		-15~50*3	
	Heating		-15~20	
Air filter (option)		Filter kit : UM-FL3EF	Filter kit : UM-FL2EF	Filter kit : UM-FL2EF
Remote control (option)		wired:RC-EX3A, RC-E5, RCH-E3 wireless:RCN-KIT4-E2		

## NOTES:

The data are measured under the following conditions(R32 : ISO-T1, -H1 / R410A : ISO-T1).  
 Cooling:Indoor temp. of 27°CDB, 19°CWB, and outdoor temp. of 35°CDB. Heating:Indoor temp. of 20°CDB, and outdoor temp. of 7°CDB, 6°CWB.  
 \*1 : Indicates the value in an anechoic chamber. During operation these values are somewhat higher due to ambient conditions.  
 \*2 : External static pressure is changeable to be set by the remote control. MAX external static pressure is "High static pressure" setting. The values of sound pressure level become 5dB(A) higher at external static pressure of 100Pa.  
 \*3 : If a cooling operation is conducted when the outdoor air temperature is -5°C or lower, the outdoor unit should be installed at a place where it is not influenced by natural wind. If wind blows, the low pressure will drop and compressor frequency will increase, this will cause the capacity to drop and may cause the unit to break down.  
 \*4 : The values are for one indoor unit operation. (Multi system only)



R32		Standard Inverter			
Set model name		FDUM71VNPVH	FDUM90VNPVH	FDUM100VNPVH	FDUM125VNPVH
Indoor unit		FDUM71VH	FDUM100VH	FDUM100VH	FDUM125VH
Outdoor unit		FDC71VNP-W	FDC90VNP-W	FDC100VNP-W	FDC125VNP-W
Power source		1 Phase 220-240V, 50Hz / 220V, 60Hz			
Nominal cooling capacity (Min~Max)		kW 7.1 ( 1.5 ~ 7.3 )	9.0 ( 2.1 ~ 9.5 )	10.0 ( 2.1 ~ 10.2 )	12.1 ( 5.0 ~ 12.1 )
Nominal heating capacity (Min~Max)		kW 7.1 ( 1.1 ~ 7.3 )	9.0 ( 1.7 ~ 9.5 )	10.0 ( 1.7 ~ 10.4 )	12.1 ( 4.0 ~ 13.3 )
Power consumption		Cooling/Heating kW 2.60 / 1.89	2.62 / 1.98	3.08 / 2.45	3.85 / 3.28
EER/COP		Cooling/Heating 2.73 / 3.76	3.44 / 4.55	3.25 / 4.08	3.14 / 3.69
Inrush current		A 5			
Max. current		15.8 19 19 20			
Sound power level*1	Indoor	Cooling/Heating 65 / 65	65 / 65	65 / 65	67 / 67
	Outdoor	Cooling/Heating 67 / 67	67 / 66	68 / 67	73 / 72
Sound pressure level*1	Indoor	Cooling (P-Hi/Hi/Me/Lo) dB(A) 38 / 33 / 29 / 25	44 / 38 / 36 / 30	44 / 38 / 36 / 30	45 / 40 / 34 / 29
	Outdoor	Heating (P-Hi/Hi/Me/Lo) 38 / 33 / 29 / 25	44 / 38 / 36 / 30	44 / 38 / 36 / 30	45 / 40 / 34 / 29
Air flow	Indoor	Cooling (P-Hi/Hi/Me/Lo) m <sup>3</sup> /min 24 / 19 / 15 / 10	36 / 28 / 25 / 19	36 / 28 / 25 / 19	39 / 32 / 26 / 20
	Outdoor	Heating (P-Hi/Hi/Me/Lo) 24 / 19 / 15 / 10	36 / 28 / 25 / 19	36 / 28 / 25 / 19	39 / 32 / 26 / 20
External static pressure*2		Pa Standard:35 Max:100	Standard:60 Max:100		
Exterior dimensions	Indoor	HeightxWidthxDepth mm 280 x 950 x 635	280 x 1,370 x 740		
	Outdoor	640 x 800(+71) x 290	750 x 880(+88) x 340	845 x 970 x 370	
Net weight	Indoor	kg 34	54		
	Outdoor	45	57	73	
Ref.piping size		Liquid/Gas ømm 6.35(1/4") / 12.7(1/2")	6.35(1/4") / 15.88(5/8")		9.52(3/8") / 15.88(5/8")
Refrigerant line (one way) length		m Max.30			
Vertical height differences		m Max.20 / Max.20			
Outdoor operating temperature range		Cooling °CDB -15~46*3	Heating °CWB -15~20		
Air filter (option)		Filter kit : UM-FL2EF		Filter kit : UM-FL3EF	
Remote control (option)		wired:RC-EX3A, RC-E5, RCH-E3 wireless:RCN-KIT4-E2			

R410A		Standard Inverter		
Set model name		FDUM71VNPVH	FDUM90VNP1VH	FDUM100VNP1VH
Indoor unit		FDUM71VH	FDUM100VH	FDUM100VH
Outdoor unit		FDC71VNP	FDC90VNP1	FDC100VNP
Power source		1 Phase 220-240V, 50Hz / 220V, 60Hz		
Nominal cooling capacity (Min~Max)		kW 7.1 ( 1.4 ~ 7.1 )	9.0 ( 1.9 ~ 9.0 )	10.0 ( 2.8 ~ 11.2 )
Nominal heating capacity (Min~Max)		kW 7.1 ( 1.0 ~ 7.1 )	9.0 ( 1.5 ~ 9.0 )	11.2 ( 2.5 ~ 12.5 )
Power consumption		Cooling/Heating kW 2.60 / 1.89	2.69 / 2.25	3.00 / 2.93
EER/COP		Cooling/Heating 2.73 / 3.76	3.35 / 4.00	3.33 / 3.82
Inrush current		A 5		
Max. current		14.5 18 22		
Sound power level*1	Indoor	Cooling/Heating 65 / 65	65 / 65	65 / 65
	Outdoor	Cooling/Heating 67 / 67	69 / 69	70 / 70
Sound pressure level*1	Indoor	Cooling (P-Hi/Hi/Me/Lo) dB(A) 38 / 33 / 29 / 25	44 / 38 / 36 / 30	44 / 38 / 36 / 30
	Outdoor	Heating (P-Hi/Hi/Me/Lo) 38 / 33 / 29 / 25	44 / 38 / 36 / 30	44 / 38 / 36 / 30
Air flow	Indoor	Cooling (P-Hi/Hi/Me/Lo) m <sup>3</sup> /min 24 / 19 / 15 / 10	36 / 28 / 25 / 19	36 / 28 / 25 / 19
	Outdoor	Heating (P-Hi/Hi/Me/Lo) 24 / 19 / 15 / 10	36 / 28 / 25 / 19	36 / 28 / 25 / 19
External static pressure*2		Pa Standard:35 Max:100	Standard:60 Max:100	
Exterior dimensions	Indoor	HeightxWidthxDepth mm 280 x 950 x 635	280 x 1,370 x 740	
	Outdoor	640 x 800(+71) x 290	750 x 880(+88) x 340	845 x 970 x 370
Net weight	Indoor	kg 34	54	
	Outdoor	45	57	70
Ref.piping size		Liquid/Gas ømm 6.35(1/4") / 12.7(1/2")	6.35(1/4") / 15.88(5/8")	
Refrigerant line (one way) length		m Max.30		
Vertical height differences		m Max.20 / Max.20		
Outdoor operating temperature range		Cooling °CDB -15~46*3	Heating °CWB -15~20	
Air filter (option)		Filter kit : UM-FL2EF		Filter kit : UM-FL3EF
Remote control (option)		wired:RC-EX3A, RC-E5, RCH-E3 wireless:RCN-KIT4-E2		

# SRK Indoor Unit Wall Mounted

**SRK 50-60**  
Only used with  
Multi System.



**SRK 71-100**  
Common to the  
both case of  
Single and Multi



**SRK 100**  
Only connected to  
R32 outdoor unit.

New



Wireless LAN Built-in



Remote control (option)

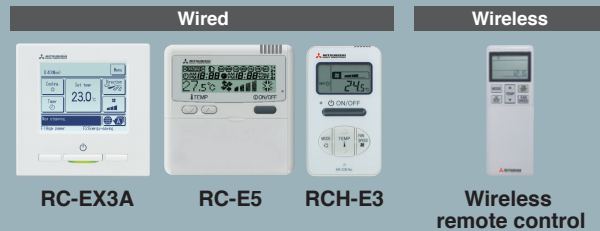

\*Not all functions available with all remote control options.

## Elegant Timeless Design

The SRK series air-conditioners have been innovatively designed with rounded contours that fit beautifully into any of Europe's diverse interior settings.

The design was created by the Italian industrial design studio Tensa srl, based in Milan, to respond to a broad spectrum of requirements.(SRK50\*60)

## Jet Air Technology

We used the same aerodynamic analysis technology as used in developing jet engines.



CFD (computational fluid dynamics), used in blade shape design of jet engines, has been applied to the design of air channels in air conditioners to develop the ideal air channel system (air circulation).  
The jet air stream generated by this air channel system can bring large volumes of air without consuming a great amount of power. While at the same time, it delivers a consistent breeze evenly throughout the room.

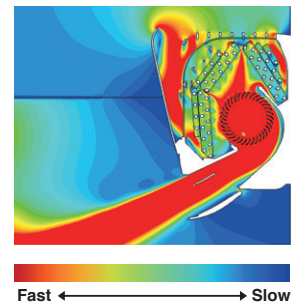

Colours in the figure show the air speed.

## Long Reach Air Flow

Long reach airflow is achieved by Jet technology. Good for large living rooms and shops, which increases comfort.



## Flap Control System

The flap can swing within the range of upper and lower flap position selected.

\* The wireless remote control is not applicable to the flap control system.

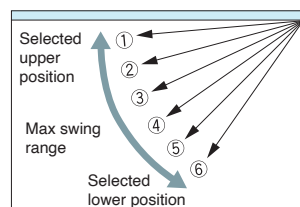

## Indoor Unit Connection

Up to three indoor units are connectable to one outdoor unit.

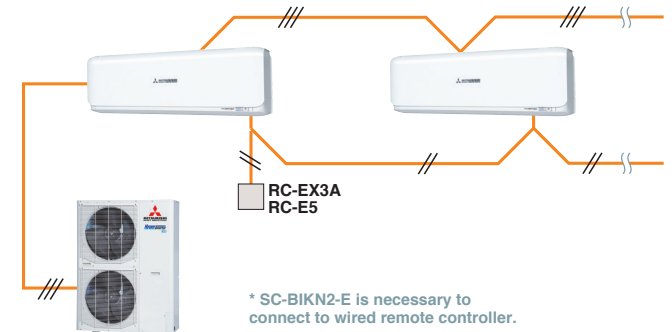

\* SC-BIKN2-E is necessary to connect to wired remote controller.

## SC-BIKN2-E connection (Option)

Interface kit can be built into indoor unit.(SRK50\*60)

**OUTDOOR UNIT**

		Hyper Inverter		Micro Inverter		
FDC		71VNX-W	100~140VN(S)X-W	100~140VN(S)A-W	-	200VSA-W
		-	100~140VN(S)X	100VN(S)A	200VSA	-
model						
Chargeless		30m		30m		
Height x Width x Depth (mm)		750 x 880(+88) x 340	1,300 x 970 x 370	845 x 970 x 370	1,300 x 970 x 370	1,505 x 970 x 370

		Standard Inverter		
FDC		71VNP-W	100VNP-W	-
		-	-	100VNP
model				
Chargeless		15m		
Height x Width x Depth (mm)		640 x 800(+71) x 290	750 x 880(+88) x 340	845 x 970 x 370

**DIMENSIONS (Unit:mm) - SRK -**

Models SRK50ZSX-W, 60ZSX-W

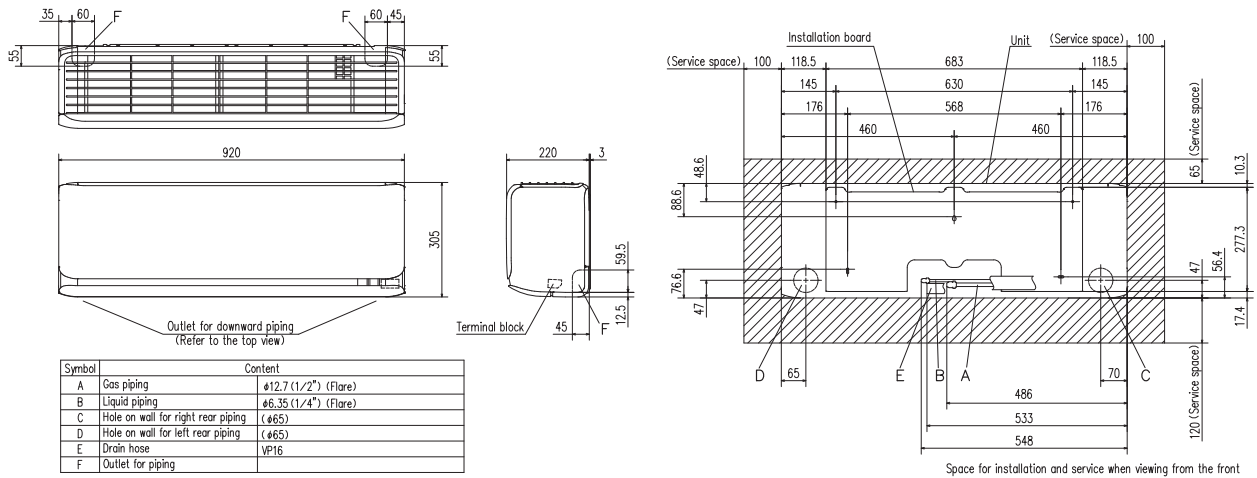

Models SRK71ZR-W, 100ZR-W, 100ZR-WF

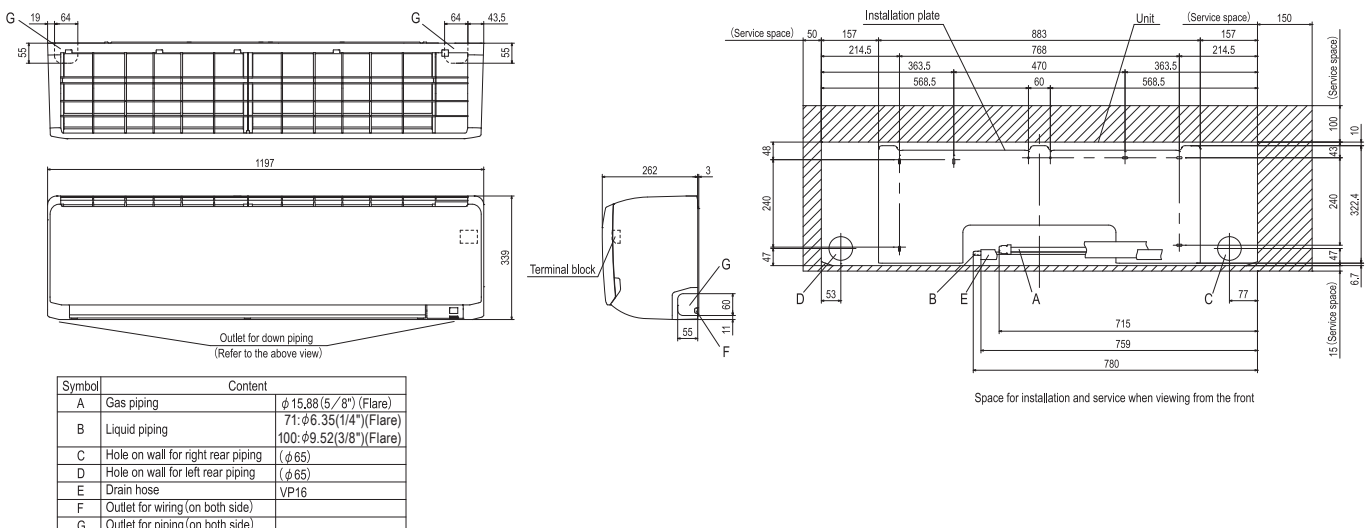

## SPECIFICATIONS - SRK -

R32		Hyper Inverter				
Set model name		SRK71VNXWZR	SRK100VNXWZRF	SRK100VNXWZR	SRK100VSXWZRF	SRK100VSXWZR
Indoor unit		SRK71ZR-W	SRK100ZR-WF	SRK100ZR-W	SRK100ZR-WF	SRK100ZR-W
Outdoor unit		FDC71VNX-W	FDC100VNX-W	FDC100VNX-W	FDC100VSX-W	FDC100VSX-W
Power source		1 Phase 220-240V, 50Hz / 220V, 60Hz			3 Phase 380-415V, 50Hz / 380V, 60Hz	
Nominal cooling capacity (Min~Max)		kW 7.1 (3.2 ~ 8.0)	10.0 (3.5 ~ 11.2)	10.0 (3.5 ~ 11.2)	10.0 (3.5 ~ 11.2)	10.0 (3.5 ~ 11.2)
Nominal heating capacity (Min~Max)		kW 8.0 (3.6 ~ 9.0)	11.2 (2.7 ~ 12.5)	11.2 (2.7 ~ 12.5)	11.2 (2.7 ~ 16.0)	11.2 (2.7 ~ 16.0)
Power consumption		Cooling/Heating kW 1.93 / 1.78	2.74 / 3.04	2.74 / 3.04	2.74 / 3.04	2.74 / 3.04
EER/COP		Cooling/Heating 3.68 / 4.49	3.65 / 3.69	3.65 / 3.69	3.65 / 3.69	3.65 / 3.69
Inrush current		A 5	5	5	5	5
Max. current		19.1	25	25	14	14
Sound power level*1	Indoor	Cooling/Heating 57 / 60	63 / 63	63 / 63	63 / 63	63 / 63
	Outdoor	Cooling/Heating 66 / 66	67 / 67	67 / 67	67 / 67	67 / 67
Sound pressure level*1	Indoor	Cooling (Hi/Me/Lo/Ulo) dB(A) 44 / 41 / 37 / 25	48 / 45 / 40 / 27	48 / 45 / 40 / 27	48 / 45 / 40 / 27	48 / 45 / 40 / 27
		Heating (Hi/Me/Lo/Ulo) 46 / 39 / 35 / 28	48 / 43 / 38 / 30	48 / 43 / 38 / 30	48 / 43 / 38 / 30	48 / 43 / 38 / 30
	Outdoor	Cooling/Heating 51 / 51	53 / 51	53 / 51	53 / 51	53 / 51
		Cooling (Hi/Me/Lo/Ulo) m³/min 20.5 / 18.6 / 16.2 / 10.4	24.5 / 21.3 / 17.6 / 10.4	24.5 / 21.3 / 17.6 / 10.4	24.5 / 21.3 / 17.6 / 10.4	24.5 / 21.3 / 17.6 / 10.4
Air flow	Indoor	Heating (Hi/Me/Lo/Ulo) 25.0 / 19.8 / 17.3 / 13.3	27.5 / 23.2 / 19.1 / 13.6	27.5 / 23.2 / 19.1 / 13.6	27.5 / 23.2 / 19.1 / 13.6	27.5 / 23.2 / 19.1 / 13.6
		Outdoor	Cooling/Heating 60 / 50	100 / 100	100 / 100	100 / 100
Exterior dimensions	Indoor	HeightxWidthxDepth mm 339 x 1,197 x 262				
	Outdoor	750 x 880(+88) x 340	1,300 x 970 x 370			
Net weight	Indoor	kg 15.5	16.5			
	Outdoor	60	97		99	
Ref.piping size	Liquid/Gas	ømm 9.52(3/8") / 15.88(5/8")				
Refrigerant line (one way) length		m Max.50		Max.100		
Vertical height differences	Outdoor is higher/lower	m Max.30 / Max.15		Max.50 / Max.15		
Outdoor operating temperature range	Cooling	°CDB -15~50*2				
	Heating	°CWB -20~20				
Air filter, Q'ty		Polypropylene net x 2(washable)				
Remote control (option)		wired:RC-EX3A, RC-E5, RCH-E3 & Interface kit:SC-BIKN2-E				

The values are for simultaneous Multi operation.

R32		Hyper Inverter		
Set model name		SRK100VNXWPZSX	SRK125VNXWPZSX	SRK140VNXWTZSX
		Twin		Triple
Indoor unit		SRK50ZSX-W x 2	SRK60ZSX-W x 2	SRK50ZSX-W x 3
Outdoor unit		FDC100VNX-W	FDC125VNX-W	FDC140VNX-W
Power source		1 Phase 220-240V, 50Hz / 220V, 60Hz		
Nominal cooling capacity (Min~Max)		kW 10.0 (3.5 ~ 11.2)	12.5 (3.5 ~ 14.0)	14.0 (3.5 ~ 16.0)
Nominal heating capacity (Min~Max)		kW 11.2 (2.7 ~ 12.5)	14.0 (2.7 ~ 17.0)	16.0 (2.7 ~ 18.0)
Power consumption		Cooling/Heating kW 2.47 / 2.60	3.43 / 3.42	4.03 / 4.04
EER/COP		Cooling/Heating 4.05 / 4.31	3.64 / 4.09	3.48 / 3.96
Inrush current		A 5	5	5
Max. current		25	27	27
Sound power level*1	Indoor*3	Cooling/Heating 59 / 62	62 / 63	59 / 62
	Outdoor	Cooling/Heating 67 / 67	68 / 70	69 / 71
Sound pressure level*1	Indoor*3	Cooling (Hi/Me/Lo/Ulo) dB(A) 44 / 39 / 31 / 22	46 / 41 / 33 / 22	44 / 39 / 31 / 22
		Heating (Hi/Me/Lo/Ulo) 46 / 41 / 33 / 23	46 / 42 / 34 / 23	46 / 41 / 33 / 23
	Outdoor	Cooling/Heating 53 / 51	53 / 54	54 / 54
		Cooling (Hi/Me/Lo/Ulo) m³/min 14.3 / 12.4 / 7.8 / 5.4	16.3 / 13.4 / 8.9 / 5.4	14.3 / 12.4 / 7.8 / 5.4
Air flow	Indoor*3	Heating (Hi/Me/Lo/Ulo) 17.3 / 14.3 / 9.8 / 6.2	17.8 / 13.7 / 10.9 / 6.2	17.3 / 14.3 / 9.8 / 6.2
		Outdoor	Cooling/Heating 100 / 100	100 / 100
Exterior dimensions	Indoor	mm 305 x 920 x 220		
	Outdoor	1,300 x 970 x 370		
Net weight	Indoor	kg 13		
	Outdoor	97		
Ref.piping size	Liquid/Gas	ømm 9.52(3/8") / 15.88(5/8")		
Refrigerant line (one way) length		m Max.100		Max.65
Vertical height differences	Outdoor is higher/lower	m Max.50 / Max.15		
Outdoor operating temperature range	Cooling	°CDB -15~50*2		
	Heating	°CWB -20~20		
Air filter, Q'ty		Polypropylene net x 2(washable)		
Remote control (option)		wired:RC-EX3A, RC-E5, RCH-E3 & Interface kit:SC-BIKN2-E		

### NOTES:

The data are measured under the following conditions (R32 : ISO-T1, -H1 / R410A : ISO-T1).

Cooling:Indoor temp. of 27°CDB, 19°CWB, and outdoor temp. of 35°CDB. Heating:Indoor temp. of 20°CDB, and outdoor temp. of 7°CDB, 6°CWB.

\*1 : Indicates the value in an anechoic chamber. During operation these values are somewhat higher due to ambient conditions.

\*2 : If a cooling operation is conducted when the outdoor air temperature is -5°C or lower, the outdoor unit should be installed at a place where it is not influenced by natural wind. If wind blows, the low pressure will drop and compressor frequency will increase, this will cause the capacity to drop and may cause the unit to break down.

\*3 : The values are for one indoor unit operation. (Multi system only)

The values are for simultaneous Multi operation.

R32			Hyper Inverter		
Set model name			SRK100VSXWPZSX	SRK125VSXWPZSX	SRK140VSXWTZSX
			Twin		Triple
Indoor unit			SRK50ZSX-W x 2	SRK60ZSX-W x 2	SRK50ZSX-W x 3
Outdoor unit			FDC100VSX-W	FDC125VSX-W	FDC140VSX-W
Power source			3 Phase 380-415V, 50Hz / 380V, 60Hz		
Nominal cooling capacity (Min~Max)		kW	10.0 ( 3.5 ~ 11.2 )	12.5 ( 3.5 ~ 14.0 )	14.0 ( 3.5 ~ 16.0 )
Nominal heating capacity (Min~Max)		kW	11.2 ( 2.7 ~ 12.5 )	14.0 ( 2.7 ~ 18.0 )	16.0 ( 2.7 ~ 20.0 )
Power consumption	Cooling/Heating	kW	2.47 / 2.60	3.43 / 3.42	4.03 / 4.04
EER/COP	Cooling/Heating		4.05 / 4.31	3.64 / 4.09	3.48 / 3.96
Inrush current		A	5	5	5
Max. current			14	14	14
Sound power level*1	Indoor*3	Cooling/Heating	59 / 62	62 / 63	59 / 62
	Outdoor	Cooling/Heating	67 / 67	68 / 70	69 / 71
Sound pressure level*1	Indoor*3	Cooling (Hi/Me/Lo/Ulo)	44 / 39 / 31 / 22	46 / 41 / 33 / 22	44 / 39 / 31 / 22
		Heating (Hi/Me/Lo/Ulo)	46 / 41 / 33 / 23	46 / 42 / 34 / 23	46 / 41 / 33 / 23
	Outdoor	Cooling/Heating	53 / 51	53 / 54	54 / 54
Air flow	Indoor*3	Cooling (Hi/Me/Lo/Ulo)	14.3 / 12.4 / 7.8 / 5.4	16.3 / 13.4 / 8.9 / 5.4	14.3 / 12.4 / 7.8 / 5.4
		Heating (Hi/Me/Lo/Ulo)	17.3 / 14.3 / 9.8 / 6.2	17.8 / 13.7 / 10.9 / 6.2	17.3 / 14.3 / 9.8 / 6.2
	Outdoor	Cooling/Heating	100 / 100	100 / 100	100 / 100
Exterior dimensions	Indoor	HeightxWidthxDepth	305 x 920 x 220		
	Outdoor		1,300 x 970 x 370		
Net weight	Indoor		13		
	Outdoor		99		
Ref.piping size	Liquid/Gas	ømm	9.52(3/8") / 15.88(5/8")		
Refrigerant line (one way) length		m	Max.100		Max.65
Vertical height differences	Outdoor is higher/lower	m	Max.50 / Max.15		
Outdoor operating temperature range	Cooling	°CDB	-15~50*2		
	Heating	°CWB	-20~20		
Air filter, Q'ty			Polypropylene net x 2(washable)		
Remote control (option)			wired:RC-EX3A, RC-E5, RCH-E3 & Interface kit:SC-BIKN2-E		

The values are for simultaneous Multi operation.

R410A			Hyper Inverter		
Set model name			SRK100VNXPZSX	SRK125VNXPZSX	SRK140VNXTZSX
			Twin		Triple
Indoor unit			SRK50ZSX-W x 2	SRK60ZSX-W x 2	SRK50ZSX-W x 3
Outdoor unit			FDC100VNX	FDC125VNX	FDC140VNX
Power source			1 Phase 220-240V, 50Hz / 220V, 60Hz		
Nominal cooling capacity (Min~Max)		kW	10.0 ( 4.0 ~ 11.2 )	12.5 ( 5.0 ~ 14.0 )	14.0 ( 5.0 ~ 16.0 )
Nominal heating capacity (Min~Max)		kW	11.2 ( 4.0 ~ 12.5 )	14.0 ( 4.0 ~ 17.0 )	16.0 ( 4.0 ~ 18.0 )
Power consumption	Cooling/Heating	kW	2.66 / 2.60	3.60 / 3.48	3.98 / 3.68
EER/COP	Cooling/Heating		3.76 / 4.31	3.47 / 4.02	3.52 / 4.35
Inrush current		A	5	5	5
Max. current			24	26	26
Sound power level*1	Indoor*3	Cooling/Heating	59 / 62	62 / 63	59 / 62
	Outdoor	Cooling/Heating	70 / 70	70 / 70	72 / 72
Sound pressure level*1	Indoor*3	Cooling (Hi/Me/Lo/Ulo)	44 / 39 / 31 / 22	46 / 41 / 33 / 22	44 / 39 / 31 / 22
		Heating (Hi/Me/Lo/Ulo)	46 / 41 / 33 / 23	46 / 42 / 34 / 23	46 / 41 / 33 / 23
	Outdoor	Cooling/Heating	48 / 50	48 / 50	49 / 52
Air flow	Indoor*3	Cooling (Hi/Me/Lo/Ulo)	14.3 / 12.4 / 7.8 / 5.4	16.3 / 13.4 / 8.9 / 5.4	14.3 / 12.4 / 7.8 / 5.4
		Heating (Hi/Me/Lo/Ulo)	17.3 / 14.3 / 9.8 / 6.2	17.8 / 13.7 / 10.9 / 6.2	17.3 / 14.3 / 9.8 / 6.2
	Outdoor	Cooling/Heating	100 / 100	100 / 100	100 / 100
Exterior dimensions	Indoor	HeightxWidthxDepth	305 x 920 x 220		
	Outdoor		1,300 x 970 x 370		
Net weight	Indoor		13		
	Outdoor		105		
Ref.piping size	Liquid/Gas	ømm	9.52(3/8") / 15.88(5/8")		
Refrigerant line (one way) length		m	Max.100		
Vertical height differences	Outdoor is higher/lower	m	Max.30 / Max.15		
Outdoor operating temperature range	Cooling	°CDB	-15~43*2		
	Heating	°CWB	-20~20		
Air filter, Q'ty			Polypropylene net x 2(washable)		
Remote control (option)			wired:RC-EX3A, RC-E5, RCH-E3 & Interface kit:SC-BIKN2-E		

# SPECIFICATIONS - SRK -

The values are for simultaneous Multi operation.

R410A		Hyper Inverter			
Set model name		SRK100VSPZSX	SRK125VSPZSX	SRK140VSTZSX	
		Twin		Triple	
Indoor unit		SRK50ZSX-W x 2	SRK60ZSX-W x 2	SRK50ZSX-W x 3	
Outdoor unit		FDC100VSX	FDC125VSX	FDC140VSX	
Power source		3 Phase 380-415V, 50Hz / 380V, 60Hz			
Nominal cooling capacity (Min~Max)	kW	10.0 ( 4.0 ~ 11.2 )	12.5 ( 5.0 ~ 14.0 )	14.0 ( 5.0 ~ 16.0 )	
Nominal heating capacity (Min~Max)	kW	11.2 ( 4.0 ~ 16.0 )	14.0 ( 4.0 ~ 18.0 )	16.0 ( 4.0 ~ 20.0 )	
Power consumption	Cooling/Heating kW	2.66 / 2.60	3.60 / 3.48	3.98 / 3.68	
EER/COP	Cooling/Heating	3.76 / 4.31	3.47 / 4.02	3.52 / 4.35	
Inrush current	A	5	5	5	
Max. current		15	15	15	
Sound power level*1	Indoor*3	Cooling/Heating	59 / 62	62 / 63	59 / 62
	Outdoor	Cooling/Heating	70 / 70	70 / 70	72 / 72
Sound pressure level*1	Indoor*3	Cooling (Hi/Me/Lo/Ulo)	44 / 39 / 31 / 22	46 / 41 / 33 / 22	44 / 39 / 31 / 22
		Heating (Hi/Me/Lo/Ulo)	46 / 41 / 33 / 23	46 / 42 / 34 / 23	46 / 41 / 33 / 23
	Outdoor	Cooling/Heating	48 / 50	48 / 50	49 / 52
Air flow	Indoor*3	Cooling (Hi/Me/Lo/Ulo)	14.3 / 12.4 / 7.8 / 5.4	16.3 / 13.4 / 8.9 / 5.4	14.3 / 12.4 / 7.8 / 5.4
		Heating (Hi/Me/Lo/Ulo)	17.3 / 14.3 / 9.8 / 6.2	17.8 / 13.7 / 10.9 / 6.2	17.3 / 14.3 / 9.8 / 6.2
	Outdoor	Cooling/Heating	100 / 100	100 / 100	100 / 100
Exterior dimensions	Indoor	HeightxWidthxDepth	305 x 920 x 220		
	Outdoor		1,300 x 970 x 370		
Net weight	Indoor		13		
	Outdoor		105		
Ref.piping size	Liquid/Gas	ømm	9.52(3/8") / 15.88(5/8")		
Refrigerant line (one way) length		m	Max.100		
Vertical height differences	Outdoor is higher/lower	m	Max.30 / Max.15		
Outdoor operating temperature range	Cooling	°CDB	-15~43*2		
	Heating	°CWB	-20~20		
Air filter, Q'ty			Polypropylene net x 2(washable)		
Remote control (option)			wired:RC-EX3A, RC-E5, RCH-E3 & Interface kit:SC-BIKN2-E		

R32		Micro Inverter			
Set model name		SRK100VNAWZRF	SRK100VNAWZR	SRK100VSAWZRF	SRK100VSAWZR
Indoor unit		SRK100ZR-WF	SRK100ZR-W	SRK100ZR-WF	SRK100ZR-W
Outdoor unit		FDC100VNA-W	FDC100VNA-W	FDC100VSA-W	FDC100VSA-W
Power source		1 Phase 220-240V, 50Hz / 220V, 60Hz		3 Phase 380-415V, 50Hz / 380V, 60Hz	
Nominal cooling capacity (Min~Max)	kW	10.0 ( 4.0 ~ 11.2 )	10.0 ( 4.0 ~ 11.2 )	10.0 ( 4.0 ~ 11.2 )	10.0 ( 4.0 ~ 11.2 )
Nominal heating capacity (Min~Max)	kW	11.2 ( 4.0 ~ 12.5 )	11.2 ( 4.0 ~ 12.5 )	11.2 ( 4.0 ~ 12.5 )	11.2 ( 4.0 ~ 12.5 )
Power consumption	Cooling/Heating kW	3.19 / 3.04	3.19 / 3.04	3.19 / 3.04	3.19 / 3.04
EER/COP	Cooling/Heating	3.13 / 3.68	3.13 / 3.68	3.13 / 3.68	3.13 / 3.68
Inrush current	A	5	5	5	5
Max. current		24	24	15	15
Sound power level*1	Indoor	Cooling/Heating	63 / 63	63 / 63	63 / 63
	Outdoor	Cooling/Heating	69 / 70	69 / 70	69 / 70
Sound pressure level*1	Indoor	Cooling (Hi/Me/Lo/Ulo)	48 / 45 / 40 / 27	48 / 45 / 40 / 27	48 / 45 / 40 / 27
		Heating (Hi/Me/Lo/Ulo)	48 / 43 / 38 / 30	48 / 43 / 38 / 30	48 / 43 / 38 / 30
	Outdoor	Cooling/Heating	54 / 55	54 / 55	54 / 55
Air flow	Indoor	Cooling (Hi/Me/Lo/Ulo)	24.5 / 21.3 / 17.6 / 10.4	24.5 / 21.3 / 17.6 / 10.4	24.5 / 21.3 / 17.6 / 10.4
		Heating (Hi/Me/Lo/Ulo)	27.5 / 23.2 / 19.1 / 13.6	27.5 / 23.2 / 19.1 / 13.6	27.5 / 23.2 / 19.1 / 13.6
	Outdoor	Cooling/Heating	75 / 73	75 / 73	75 / 73
Exterior dimensions	Indoor	HeightxWidthxDepth	339 x 1,197 x 262		
	Outdoor		845 x 970 x 370		
Net weight	Indoor		16.5		
	Outdoor		77		78
Ref.piping size	Liquid/Gas	ømm	9.52(3/8") / 15.88(5/8")		
Refrigerant line (one way) length		m	Max.50		
Vertical height differences	Outdoor is higher/lower	m	Max.50 / Max.15		
Outdoor operating temperature range	Cooling	°CDB	-15~50*2		
	Heating	°CWB	-20~20		
Air filter, Q'ty			Polypropylene net x2 (Washable)		
Remote control (option)			wired:RC-EX3A, RC-E5, RCH-E3 & Interface kit:SC-BIKN2-E		

## NOTES:

The data are measured under the following conditions (R32 : ISO-T1, -H1 / R410A : ISO-T1).  
 Cooling:Indoor temp. of 27°CDB, 19°CWB, and outdoor temp. of 35°CDB. Heating:Indoor temp. of 20°CDB, and outdoor temp. of 7°CDB, 6°CWB.  
 \*1 : Indicates the value in an anechoic chamber. During operation these values are somewhat higher due to ambient conditions.  
 \*2 : If a cooling operation is conducted when the outdoor air temperature is -5°C or lower, the outdoor unit should be installed at a place where it is not influenced by natural wind. If wind blows, the low pressure will drop and compressor frequency will increase, this will cause the capacity to drop and may cause the unit to break down.  
 \*3 : The values are for one indoor unit operation. (Multi system only)

The values are for simultaneous Multi operation.

R32		Micro Inverter			
Set model name		SRK100VNAWPZSX	SRK125VNAWPZSX	SRK140VNAWPZR	SRK140VNAWTZSX
		Twin		Triple	
Indoor unit		SRK50ZSX-W x 2	SRK60ZSX-W x 2	SRK71ZR-W x 2	SRK50ZSX-W x 3
Outdoor unit		FDC100VNA-W	FDC125VNA-W	FDC140VNA-W	FDC140VNA-W
Power source		1 Phase 220-240V, 50Hz / 220V, 60Hz			
Nominal cooling capacity (Min~Max)	kW	10.0 ( 4.0 ~ 11.2 )	12.5 ( 5.0 ~ 14.0 )	13.6 ( 5.0 ~ 14.5 )	13.6 ( 5.0 ~ 14.5 )
Nominal heating capacity (Min~Max)	kW	11.2 ( 4.0 ~ 12.5 )	14.0 ( 4.0 ~ 16.0 )	15.5 ( 4.0 ~ 16.5 )	15.5 ( 4.0 ~ 16.5 )
Power consumption	Cooling/Heating	2.89 / 2.61	4.54 / 3.58	4.26 / 4.03	4.26 / 3.74
EER/COP	Cooling/Heating	3.46 / 4.29	2.76 / 3.91	3.19 / 3.85	3.19 / 4.14
Inrush current		5	5	5	5
Max. current		24	24	24	24
Sound power level*1	Indoor <sup>3</sup>	Cooling/Heating	59 / 62	62 / 63	57 / 60
	Outdoor	Cooling/Heating	69 / 70	71 / 71	72 / 73
Sound pressure level*1	Indoor <sup>3</sup>	Cooling (Hi/Me/Lo/Ulo)	44 / 39 / 31 / 22	46 / 41 / 33 / 22	44 / 41 / 37 / 25
		Heating (Hi/Me/Lo/Ulo)	46 / 41 / 33 / 23	46 / 42 / 34 / 23	46 / 39 / 35 / 28
	Outdoor	Cooling/Heating	54 / 55	54 / 56	56 / 58
Air flow	Indoor <sup>3</sup>	Cooling (Hi/Me/Lo/Ulo)	14.3 / 12.4 / 7.8 / 5.4	16.3 / 13.4 / 8.9 / 5.4	20.5 / 18.6 / 16.2 / 10.4
		Heating (Hi/Me/Lo/Ulo)	17.3 / 14.3 / 9.8 / 6.2	17.8 / 13.7 / 10.9 / 6.2	25.0 / 19.8 / 17.3 / 13.3
	Outdoor	Cooling/Heating	75 / 73	75 / 73	75 / 73
Exterior dimensions	Indoor	HeightxWidthxDepth	305 x 920 x 220		305 x 920 x 220
	Outdoor		845 x 970 x 370		
Net weight	Indoor		13		13
	Outdoor		77		
Ref.piping size	Liquid/Gas		9.52(3/8") / 15.88(5/8")		
Refrigerant line (one way) length			Max.50		
Vertical height differences	Outdoor is higher/lower		Max.50 / Max.15		
Outdoor operating temperature range	Cooling	°CDB	-15~50*2		
	Heating	°CWB	-20~20		
Air filter, Q'ty			Polypropylene net x 2(washable)		
Remote control (option)			wired:RC-EX3A, RC-E5, RCH-E3 & Interface kit:SC-BIKN2-E		

The values are for simultaneous Multi operation.

R32		Micro Inverter			
Set model name		SRK100VSAWPZSX	SRK125VSAWPZSX	SRK140VSAWPZR	SRK140VSAWTZSX
		Twin		Triple	
Indoor unit		SRK50ZSX-W x 2	SRK60ZSX-W x 2	SRK71ZR-W x 2	SRK50ZSX-W x 3
Outdoor unit		FDC100VSA-W	FDC125VSA-W	FDC140VSA-W	FDC140VSA-W
Power source		3 Phase 380-415V, 50Hz / 380V, 60Hz			
Nominal cooling capacity (Min~Max)	kW	10.0 ( 4.0 ~ 11.2 )	12.5 ( 5.0 ~ 14.0 )	13.6 ( 5.0 ~ 14.5 )	13.6 ( 5.0 ~ 14.5 )
Nominal heating capacity (Min~Max)	kW	11.2 ( 4.0 ~ 12.5 )	14.0 ( 4.0 ~ 16.0 )	15.5 ( 4.0 ~ 16.5 )	15.5 ( 4.0 ~ 16.5 )
Power consumption	Cooling/Heating	2.89 / 2.61	4.54 / 3.58	4.26 / 4.03	4.26 / 3.74
EER/COP	Cooling/Heating	3.46 / 4.29	2.76 / 3.91	3.19 / 3.85	3.19 / 4.14
Inrush current		5	5	5	5
Max. current		15	15	15	15
Sound power level*1	Indoor <sup>3</sup>	Cooling/Heating	59 / 62	62 / 63	57 / 60
	Outdoor	Cooling/Heating	69 / 70	71 / 71	72 / 73
Sound pressure level*1	Indoor <sup>3</sup>	Cooling (Hi/Me/Lo/Ulo)	44 / 39 / 31 / 22	46 / 41 / 33 / 22	44 / 41 / 37 / 25
		Heating (Hi/Me/Lo/Ulo)	46 / 41 / 33 / 23	46 / 42 / 34 / 23	46 / 39 / 35 / 28
	Outdoor	Cooling/Heating	54 / 55	54 / 56	56 / 58
Air flow	Indoor <sup>3</sup>	Cooling (Hi/Me/Lo/Ulo)	14.3 / 12.4 / 7.8 / 5.4	16.3 / 13.4 / 8.9 / 5.4	20.5 / 18.6 / 16.2 / 10.4
		Heating (Hi/Me/Lo/Ulo)	17.3 / 14.3 / 9.8 / 6.2	17.8 / 13.7 / 10.9 / 6.2	25.0 / 19.8 / 17.3 / 13.3
	Outdoor	Cooling/Heating	75 / 73	75 / 73	75 / 73
Exterior dimensions	Indoor	HeightxWidthxDepth	305 x 920 x 220		305 x 920 x 220
	Outdoor		845 x 970 x 370		
Net weight	Indoor		13		13
	Outdoor		78		
Ref.piping size	Liquid/Gas		9.52(3/8") / 15.88(5/8")		
Refrigerant line (one way) length			Max.50		
Vertical height differences	Outdoor is higher/lower		Max.50 / Max.15		
Outdoor operating temperature range	Cooling	°CDB	-15~50*2		
	Heating	°CWB	-20~20		
Air filter, Q'ty			Polypropylene net x 2(washable)		
Remote control (option)			wired:RC-EX3A, RC-E5, RCH-E3 & Interface kit:SC-BIKN2-E		

## SPECIFICATIONS - SRK -

R32		Micro Inverter		
Set model name		SRK200VSAWPZRF		SRK200VSAWPZR
Indoor unit		SRK100ZR-WF x 2		SRK100ZR-W x 2
Outdoor unit		FDC200VSA-W		FDC200VSA-W
Power source		3 Phase 380-415V, 50Hz / 380V, 60Hz		
Nominal cooling capacity (Min~Max)	kW	20.0 ( 7.0 ~ 22.4 )		20.0 ( 7.0 ~ 22.4 )
Nominal heating capacity (Min~Max)	kW	22.4 ( 6.6 ~ 25.0 )		22.4 ( 6.6 ~ 25.0 )
Power consumption	Cooling/Heating	7.46 / 6.87		7.46 / 6.87
EER/COP	Cooling/Heating	2.68 / 3.26		2.68 / 3.26
Inrush current		5		5
Max. current		19		19
Sound power level*1	Indoor	Cooling/Heating	63 / 63	
	Outdoor	Cooling/Heating	72 / 74	
Sound pressure level*1	Indoor	Cooling (Hi/Me/Lo/Ulo)	48 / 45 / 40 / 27	
		Heating (Hi/Me/Lo/Ulo)	48 / 43 / 38 / 30	
	Outdoor	Cooling/Heating	58 / 59	
		Cooling (Hi/Me/Lo/Ulo)	24.5 / 21.3 / 17.6 / 10.4	
Air flow	Indoor	Heating (Hi/Me/Lo/Ulo)	27.5 / 23.2 / 19.1 / 13.6	
		Cooling/Heating	148 / 134	
Exterior dimensions	Indoor	HeightxWidthxDepth	339 x 1,197 x 262	
	Outdoor		1,505 x 970 x 370	
Net weight	Indoor		16.5	
	Outdoor		144	
Ref.piping size	Liquid/Gas	ømm	9.52(3/8") / 22.22(7/8")	
Refrigerant line (one way) length		m	Max.70	
Vertical height differences	Outdoor is higher/lower	m	Max.50 <sup>4</sup> / Max.15	
Outdoor operating temperature range	Cooling	°CDB	-15~-50 <sup>2</sup>	
	Heating	°CWB	-20~-20	
Air filter, Q'ty			Polypropylene net x2 (Washable)	
Remote control (option)			wired:RC-EX3A, RC-E5, RCH-E3 & Interface kit:SC-BIKN2-E	

The values are for simultaneous Multi operation.

R410A		Micro Inverter		
Set model name		SRK100VNAZR	SRK100VSAZR	SRK200VSAAPZR
Indoor unit		SRK100ZR-W	SRK100ZR-W	SRK100ZR-W x 2
Outdoor unit		FDC100VNA	FDC100VSA	FDC200VSA
Power source		1 Phase 220-240V, 50Hz / 220V, 60Hz	3 Phase 380-415V, 50Hz / 380V, 60Hz	
Nominal cooling capacity (Min~Max)	kW	10.0 ( 4.0 ~ 11.2 )	10.0 ( 4.0 ~ 11.2 )	19.0 ( 5.2 ~ 22.4 )
Nominal heating capacity (Min~Max)	kW	11.2 ( 4.0 ~ 12.5 )	11.2 ( 4.0 ~ 12.5 )	22.4 ( 3.3 ~ 25.0 )
Power consumption	Cooling/Heating	3.19 / 2.78	3.19 / 2.78	7.52 / 7.41
EER/COP	Cooling/Heating	3.13 / 4.03	3.13 / 4.03	2.53 / 3.02
Inrush current		5	5	5
Max. current		24	15	20
Sound power level*1	Indoor*3	Cooling/Heating	63 / 63	
	Outdoor	Cooling/Heating	70 / 70	
Sound pressure level*1	Indoor*3	Cooling (Hi/Me/Lo/Ulo)	48 / 45 / 40 / 27	
		Heating (Hi/Me/Lo/Ulo)	48 / 43 / 38 / 30	
	Outdoor	Cooling/Heating	54 / 56	
		Cooling (Hi/Me/Lo/Ulo)	24.5 / 21.3 / 17.6 / 10.4	
Air flow	Indoor*3	Heating (Hi/Me/Lo/Ulo)	27.5 / 23.2 / 19.1 / 13.6	
		Cooling/Heating	75 / 73	
Exterior dimensions	Indoor	HeightxWidthxDepth	339 x 1,197 x 262	
	Outdoor		845 x 970 x 370	
Net weight	Indoor		16.5	
	Outdoor		82	
Ref.piping size	Liquid/Gas	ømm	9.52(3/8") / 15.88(5/8")	
Refrigerant line (one way) length		m	Max.50	
Vertical height differences	Outdoor is higher/lower	m	Max.50 / Max.15	
Outdoor operating temperature range	Cooling	°CDB	-15~-50 <sup>2</sup>	
	Heating	°CWB	-20~-20	
Air filter, Q'ty			Polypropylene net x2 (Washable)	
Remote control (option)			wired:RC-EX3A, RC-E5, RCH-E3 & Interface kit:SC-BIKN2-E	

### NOTES:

The data are measured under the following conditions (R32 : ISO-T1, -H1 / R410A : ISO-T1).

Cooling:Indoor temp. of 27°CDB, 19°CWB, and outdoor temp. of 35°CDB. Heating:Indoor temp. of 20°CDB, and outdoor temp. of 7°CDB, 6°CWB.

\*1 : Indicates the value in an anechoic chamber. During operation these values are somewhat higher due to ambient conditions.

\*2 : If a cooling operation is conducted when the outdoor air temperature is -5°C or lower, the outdoor unit should be installed at a place where it is not influenced by natural wind. If wind blows, the low pressure will drop and compressor frequency will increase, this will cause the capacity to drop and may cause the unit to break down.

\*3 : The values are for one indoor unit operation. (Multi system only)

\*4 : In case of following conditions:Max.50m(Outdoor unit is higher & Outdoor temperature ≤ 43°C), Max.30m(Outdoor unit is higher & Outdoor temperature > 43°C)



R32		Standard Inverter		
Set model name		SRK71VNPWZR	SRK100VNPWZRF	SRK100VNPWZR
Indoor unit		SRK71ZR-W	SRK100ZR-WF	SRK100ZR-W
Outdoor unit		FDC71VNP-W	FDC100VNP-W	FDC100VNP-W
Power source		1 Phase 220-240V, 50Hz / 220V, 60Hz		
Nominal cooling capacity (Min~Max)		kW 7.1 ( 1.5 ~ 7.3 )	9.6 ( 2.1 ~ 9.6 )	9.6 ( 2.1 ~ 9.6 )
Nominal heating capacity (Min~Max)		kW 7.1 ( 1.1 ~ 7.3 )	10.0 ( 1.7 ~ 10.4 )	10.0 ( 1.7 ~ 10.4 )
Power consumption	Cooling/Heating	kW 2.36 / 1.88	3.10 / 2.80	3.10 / 2.80
EER/COP	Cooling/Heating	3.01 / 3.78	3.10 / 3.57	3.10 / 3.57
Inrush current		A 5	5	5
Max. current		15.8	19	19
Sound power level*1	Indoor*3	Cooling/Heating	57 / 60	63 / 63
	Outdoor	Cooling/Heating	67 / 67	68 / 67
Sound pressure level*1	Indoor*3	Cooling (Hi/Me/Lo/Ulo)	44 / 41 / 37 / 25	48 / 45 / 40 / 27
		Heating (Hi/Me/Lo/Ulo)	46 / 39 / 35 / 28	48 / 43 / 38 / 30
	Outdoor	Cooling/Heating	54 / 54	56 / 54
		Cooling/Heating	20.5 / 18.6 / 16.2 / 10.4	24.5 / 21.3 / 17.6 / 10.4
Air flow	Indoor*3	Heating (Hi/Me/Lo/Ulo)	25.0 / 19.8 / 17.3 / 13.3	27.5 / 23.2 / 19.1 / 13.6
		Cooling/Heating	42 / 42	63 / 55
Exterior dimensions	Indoor	HeightxWidthxDepth	mm 339 x 1,197 x 262	
	Outdoor		640 x 800(+71) x 290	750 x 880(+88) x 340
Net weight	Indoor		kg 15.5	
	Outdoor		45	57
Ref.piping size	Liquid/Gas	ømm	6.35(1/4") / 12.7(1/2") 6.35(1/4") / 15.88(5/28") 6.35(1/4") / 15.88(5/28")	
Refrigerant line (one way) length		m	Max.30	
Vertical height differences		Outdoor is higher/lower	m Max.20 / Max.20	
Outdoor operating temperature range	Cooling	°CDB	-15~46*2	
	Heating	°CWB	-15~20	
Air filter, Q'ty			Polypropylene net x2 (Washable)	
Remote control (option)			wired:RC-EX3A, RC-E5, RCH-E3 & Interface kit:SC-BIKN2-E	

R410A		Standard Inverter		
Set model name		SRK100VNPW1ZR		
Indoor unit		SRK100ZR-W		
Outdoor unit		FDC100VNP		
Power source		1 Phase 220-240V, 50Hz / 220V, 60Hz		
Nominal cooling capacity (Min~Max)		kW	10.0 ( 2.4 ~ 10.5 )	
Nominal heating capacity (Min~Max)		kW	11.2 ( 3.2 ~ 11.5 )	
Power consumption	Cooling/Heating	kW	3.09 / 3.28	
EER/COP	Cooling/Heating		3.24 / 3.41	
Inrush current		A	14.4	
Max. current			21	
Sound power level*1	Indoor*3	Cooling/Heating	63 / 63	
	Outdoor	Cooling/Heating	70 / 74	
Sound pressure level*1	Indoor*3	Cooling (Hi/Me/Lo/Ulo)	48 / 45 / 40 / 27	
		Heating (Hi/Me/Lo/Ulo)	48 / 43 / 38 / 30	
	Outdoor	Cooling/Heating	57 / 61	
		Cooling/Heating	24.5 / 21.3 / 17.6 / 10.4	27.5 / 23.2 / 19.1 / 13.6
Air flow	Indoor*3	Heating (Hi/Me/Lo/Ulo)	75 / 80	
		Cooling/Heating	75 / 80	
Exterior dimensions	Indoor	HeightxWidthxDepth	mm 339 x 1,197 x 262	
	Outdoor		845 x 970 x 370	
Net weight	Indoor		kg 16.5	
	Outdoor		70	
Ref.piping size	Liquid/Gas	ømm	9.52(3/8") / 15.88(5/8")	
Refrigerant line (one way) length		m	Max.30	
Vertical height differences		Outdoor is higher/lower	m Max.20 / Max.20	
Outdoor operating temperature range	Cooling	°CDB	-15~46*2	
	Heating	°CWB	-15~20	
Air filter, Q'ty			Polypropylene net x2 (Washable)	
Remote control (option)			wired:RC-EX3A, RC-E5, RCH-E3 & Interface kit:SC-BIKN2-E	

# FDE

## Indoor Unit Ceiling Suspended



FDE 40/50/60/71/100/125/140



- Energy Saving
- Home Leave
- Hi Power
- Silent Operation
- Flap Control
- Favourite Setting



### Remote control (option)

Wired			Wireless	
RC-EX3A	RC-E5	RCH-E3	RCN-E-E3	

\*Not all functions available with all remote control options.

## High Efficiency

Energy efficiency was improved by use of DC fan motor & high efficient heat exchanger.

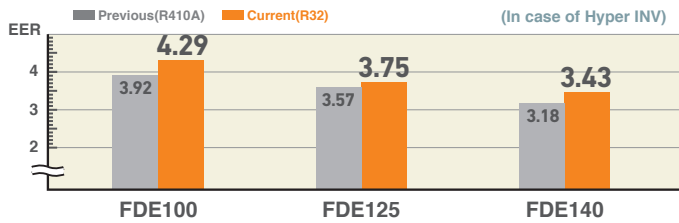

## Lighter than ever

By decreasing the numbers of fan motors from two to one, we reduced the overall weight of our FDE units.

	Previous (VF)	Current (VH)	
60-71VH	37	33	4kg less!!
100-125-140VH	49	43	6kg less!!

## Reduced Noise

The industry's lowest sound pressure levels were achieved by decreasing air flow volume, decreasing pressure loss with employment of one fan motor and optimizing casing and distributor shape.

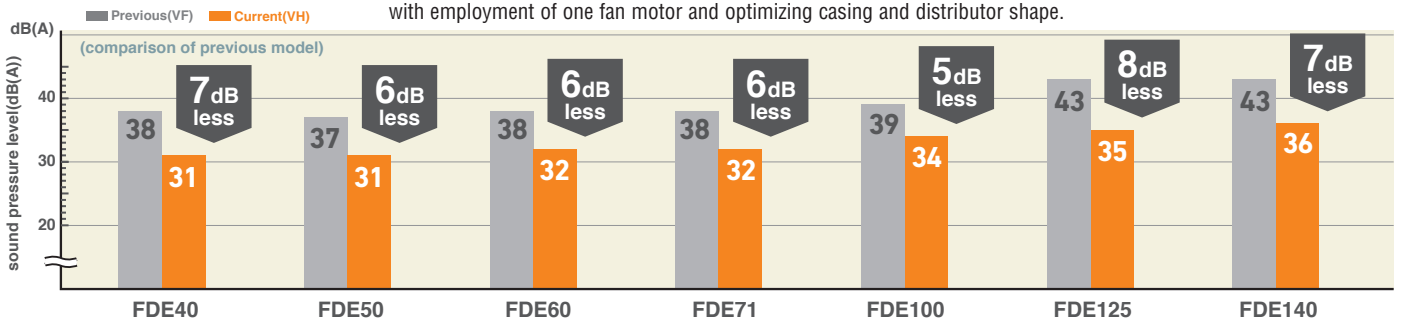

## Flap Control System

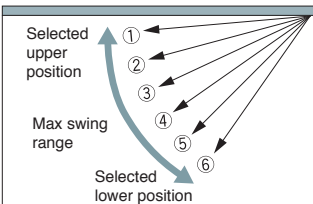

The flap can swing within the range of upper and lower flap position selected.

\* The wireless remote control is not applicable to the flap control system.

## Motion Sensor (Option)

Motion sensor is equipped in the panel and detects the presence/absence and activity of humans in a room to improve the comfort and energy saving performance of the unit.

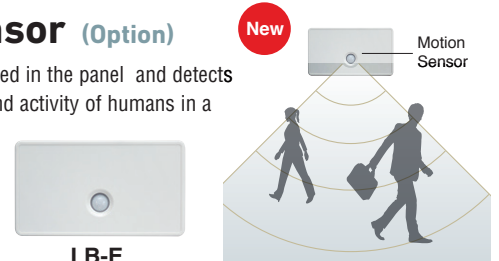

## Improved Installation Workability

The refrigerant pipe from the unit can be arranged in three directions, rear, right and up. The drain pipe can be arranged in two directions, left and right. This will allow a free layout of piping for various installation conditions. The unit can only be serviced from the bottom.



### OUTDOOR UNIT

		Hyper Inverter		
SRC · FDC	 	40~60ZSX-W1,-W2	71VNX-W	100~140VN(S)X-W
		40~60ZSX-S	71VNX	100~140VN(S)X
model				
Chargeless		15m	30m	
Height x Width x Depth (mm)		640 x 800(+71) x 290	750 x 880(+88) x 340	1,300 x 970 x 370

		Micro Inverter			Standard Inverter		
FDC	 	100~140VN(S)A-W	—	200·250·280VSA-W	71VNP-W	90~100VNP-W	125VNP-W
		100~140VN(S)A	200VSA	250VSA	71VNP	90VNP1	100VNP
model							
Chargeless		30m			15m		
Height x Width x Depth (mm)		845 x 970 x 370	1,300 x 970 x 370	1,505 x 970 x 370	640 x 800(+71) x 290	750 x 880(+88) x 340	845 x 970 x 370

### DIMENSIONS (Unit:mm) - FDE -

#### Models FDE40VH, 50VH

Note (1) The model name label is attached on the fan casing inside the air return grille.

Symbol	Content
A	Gas piping $\phi 12.7$ (1/2") (Flare)
B	Liquid piping $\phi 6.35$ (1/4") (Flare)
C <sub>1,2</sub>	Drain piping VP20 (I.D.20, O.D.26)
D	Hole for suspension bolts (M10 or M8)
E	Back cutout PE cover
F	Top cutout Plate cover
G	Drain piping (for left back) (Knock out)

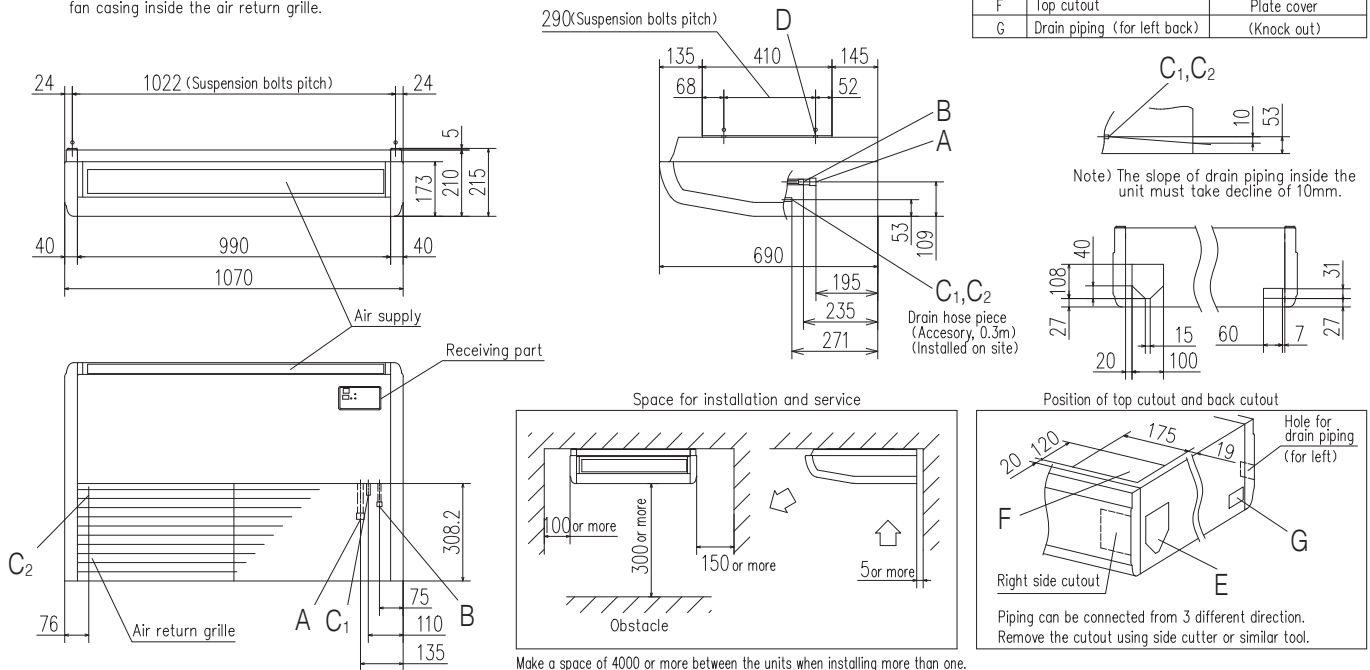

Make a space of 4000 or more between the units when installing more than one.

# DIMENSIONS (Unit:mm) - FDE -

## Models FDE60VH, 71VH

Note (1) The model name label is attached on the fan casing inside the air return grille.

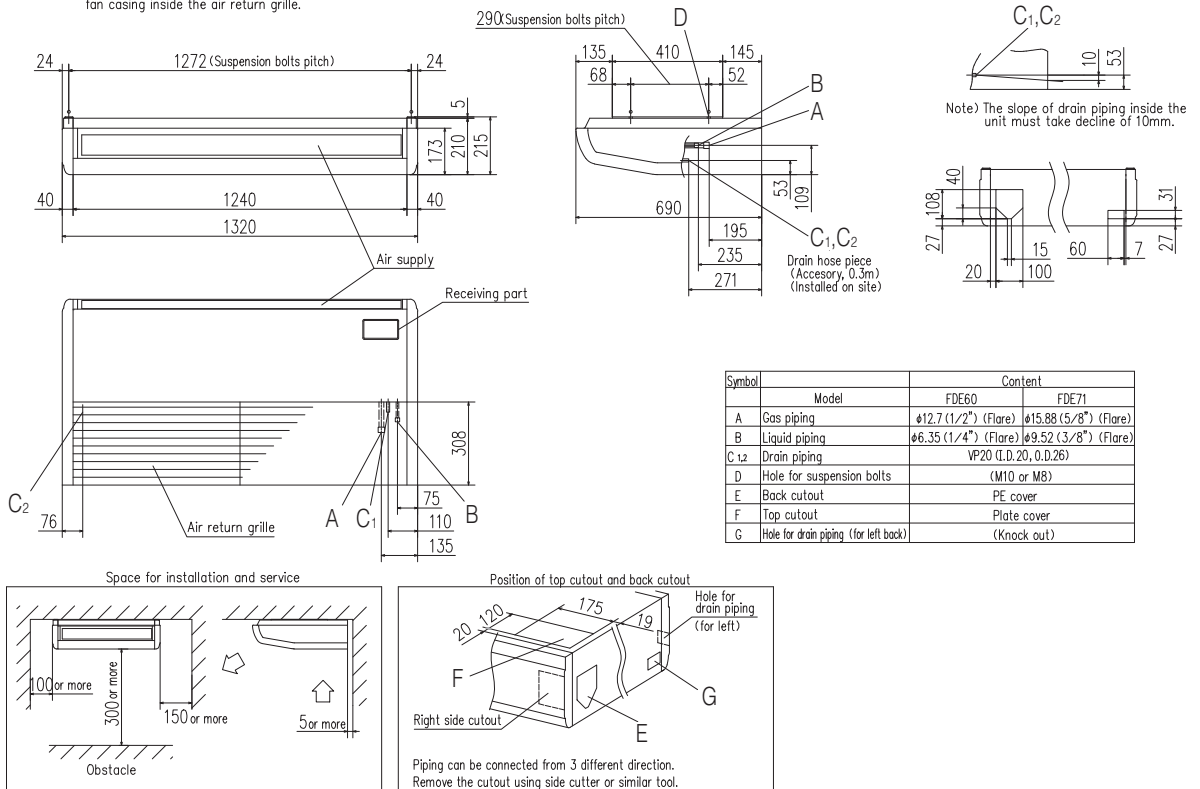

## Models FDE100VH, 125VH, 140VH

Note (1) The model name label is attached on the fan casing inside the air return grille.

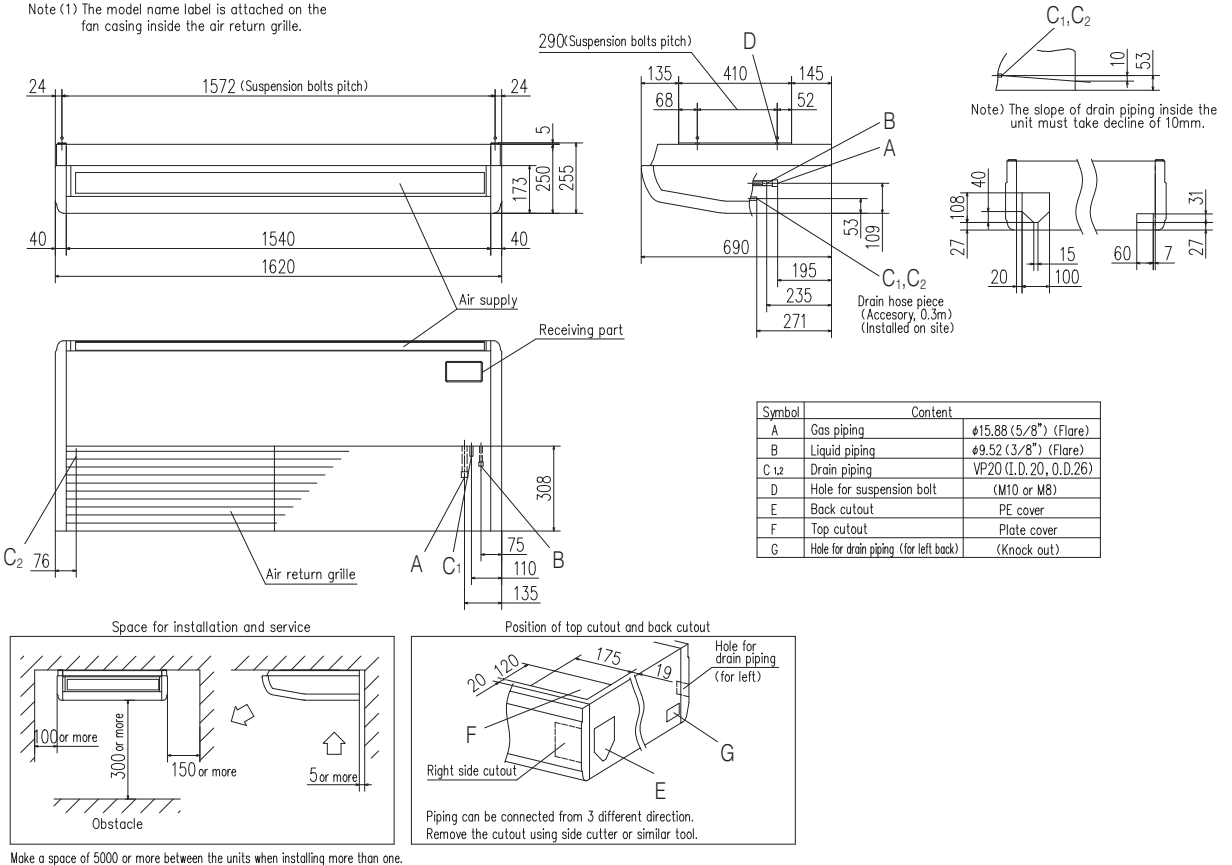

R32		Hyper Inverter		
Set model name		FDE40ZSXW1VH	FDE50ZSXW2VH	FDE60ZSXW1VH
Indoor unit		FDE40VH	FDE50VH	FDE60VH
Outdoor unit		SRC40ZSX-W1	SRC50ZSX-W2	SRC60ZSX-W1
Power source		1 Phase 220-240V, 50Hz / 220V, 60Hz		
Nominal cooling capacity (Min~Max)		kW 4.0 ( 1.1 ~ 4.7 )	5.0 ( 1.1 ~ 5.6 )	5.6 ( 1.1 ~ 6.3 )
Nominal heating capacity (Min~Max)		kW 4.5 ( 0.6 ~ 5.4 )	5.4 ( 0.6 ~ 6.3 )	6.7 ( 0.6 ~ 7.1 )
Power consumption		Cooling/Heating kW 1.02 / 1.10	1.43 / 1.46	1.51 / 1.86
EER/COP		Cooling/Heating 3.92 / 4.09	3.49 / 3.70	3.71 / 3.60
Inrush current		A 5	5	5
Max. current		15	15	15
Sound power level*1	Indoor	Cooling/Heating 60 / 60	60 / 60	60 / 60
	Outdoor	Cooling/Heating 63 / 62	63 / 62	65 / 65
Sound pressure level*1	Indoor	Cooling (P-Hi/Hi/Me/Lo) dB(A) 46 / 38 / 36 / 31	46 / 38 / 36 / 31	47 / 41 / 37 / 32
		Heating (P-Hi/Hi/Me/Lo) 46 / 38 / 36 / 31	46 / 38 / 36 / 31	47 / 41 / 37 / 32
	Outdoor	Cooling/Heating 52 / 50	52 / 50	53 / 54
		Air flow	Indoor Cooling (P-Hi/Hi/Me/Lo) m³/min 13 / 10 / 9 / 7	13 / 10 / 9 / 7
	Indoor Heating (P-Hi/Hi/Me/Lo) 13 / 10 / 9 / 7	13 / 10 / 9 / 7	20 / 16 / 13 / 10	
	Outdoor Cooling/Heating 33 / 33	39 / 33	41.5 / 39	
Exterior dimensions	Indoor	HeightxWidthxDepth mm 210 x 1,070 x 690		210 x 1,320 x 690
	Outdoor	640 x 800(+71) x 290		
Net weight	Indoor	kg 28		33
	Outdoor	45		
Ref.piping size	Liquid/Gas	ømm 6.35(1/4") / 12.7(1/2")		
Refrigerant line (one way) length	m	Max.30		
Vertical height differences	Outdoor is higher/lower	m Max.20 / Max.20		
Outdoor operating temperature range	Cooling	°CDB -15~46*2		
	Heating	°CWB -20~20		
Air filter, Q'ty		Pocket Plastic net x2(Washable)		
Remote control (option)		wired:RC-EX3A, RC-E5, RCH-E3 wireless:RCN-E-E3		

R32		Hyper Inverter			
Set model name		FDE71VNXWVH	FDE100VNXWVH	FDE125VNXWVH	FDE140VNXWVH
Indoor unit		FDE71VH	FDE100VH	FDE125VH	FDE140VH
Outdoor unit		FDC71VNX-W	FDC100VNX-W	FDC125VNX-W	FDC140VNX-W
Power source		1 Phase 220-240V, 50Hz / 220V, 60Hz			
Nominal cooling capacity (Min~Max)		kW 7.1 ( 3.2 ~ 8.0 )	10.0 ( 3.5 ~ 11.2 )	12.5 ( 3.5 ~ 14.0 )	14.0 ( 3.5 ~ 16.0 )
Nominal heating capacity (Min~Max)		kW 8.0 ( 3.6 ~ 9.0 )	11.2 ( 2.7 ~ 12.5 )	14.0 ( 2.7 ~ 17.0 )	16.0 ( 2.7 ~ 18.0 )
Power consumption		Cooling/Heating kW 1.87 / 1.87	2.33 / 2.52	3.34 / 3.74	4.08 / 4.41
EER/COP		Cooling/Heating 3.80 / 4.28	4.29 / 4.45	3.75 / 3.74	3.43 / 3.63
Inrush current		A 5	5	5	5
Max. current		19.1	25	27	27
Sound power level*1	Indoor	Cooling/Heating 60 / 60	64 / 64	64 / 64	65 / 65
	Outdoor	Cooling/Heating 66 / 66	67 / 67	68 / 70	69 / 71
Sound pressure level*1	Indoor	Cooling (P-Hi/Hi/Me/Lo) dB(A) 47 / 41 / 37 / 32	48 / 43 / 38 / 34	48 / 45 / 40 / 35	49 / 45 / 40 / 36
		Heating (P-Hi/Hi/Me/Lo) 47 / 41 / 37 / 32	48 / 43 / 38 / 34	48 / 45 / 40 / 35	49 / 45 / 40 / 36
	Outdoor	Cooling/Heating 51 / 51	53 / 51	53 / 54	54 / 54
		Air flow	Indoor Cooling (P-Hi/Hi/Me/Lo) m³/min 20 / 16 / 13 / 10	32 / 26 / 21 / 16.5	32 / 29 / 23 / 17
	Indoor Heating (P-Hi/Hi/Me/Lo) 20 / 16 / 13 / 10	32 / 26 / 21 / 16.5	32 / 29 / 23 / 17	34 / 29 / 23 / 18	
	Outdoor Cooling/Heating 60 / 50	100 / 100	100 / 100	100 / 100	
Exterior dimensions	Indoor	HeightxWidthxDepth mm 210 x 1,320 x 690		250 x 1,620 x 690	
	Outdoor	750 x 880(+88) x 340		1,300 x 970 x 370	
Net weight	Indoor	kg 33		43	
	Outdoor	60		97	
Ref.piping size	Liquid/Gas	ømm 9.52(3/8") / 15.88(5/8")			
Refrigerant line (one way) length	m	Max.50		Max.100	
Vertical height differences	Outdoor is higher/lower	m Max.30 / Max.15		Max.50 / Max.15	
Outdoor operating temperature range	Cooling	°CDB -15~50*2			
	Heating	°CWB -20~20			
Air filter, Q'ty		Pocket Plastic net x2(Washable)			
Remote control (option)		wired:RC-EX3A, RC-E5, RCH-E3 wireless:RCN-E-E3			

**NOTES:**

The data are measured under the following conditions( ISO-T1, -H1).  
 Cooling:Indoor temp. of 27°CDB, 19°CWB, and outdoor temp. of 35°CDB. Heating:Indoor temp. of 20°CDB, and outdoor temp. of 7°CDB, 6°CWB.  
 \*1 : Indicates the value in an anechoic chamber. During operation these values are somewhat higher due to ambient conditions.  
 \*2 : If a cooling operation is conducted when the outdoor air temperature is -5°C or lower, the outdoor unit should be installed at a place where it is not influenced by natural wind. If wind blows, the low pressure will drop and compressor frequency will increase, this will cause the capacity to drop and may cause the unit to break down.

## SPECIFICATIONS - FDE -

R32		Hyper Inverter		
Set model name		FDE100VSXWVH	FDE125VSXWVH	FDE140VSXWVH
Indoor unit		FDE100VH	FDE125VH	FDE140VH
Outdoor unit		FDC100VSX-W	FDC125VSX-W	FDC140VSX-W
Power source		3 Phase 380-415V, 50Hz / 380V, 60Hz		
Nominal cooling capacity (Min~Max)		kW 10.0 (3.5 ~ 11.2)	12.5 (3.5 ~ 14.0)	14.0 (3.5 ~ 16.0)
Nominal heating capacity (Min~Max)		kW 11.2 (2.7 ~ 16.0)	14.0 (2.7 ~ 18.0)	16.0 (2.7 ~ 20.0)
Power consumption		Cooling/Heating kW 2.33 / 2.52	3.34 / 3.74	4.08 / 4.41
EER/COP		Cooling/Heating 4.29 / 4.45	3.75 / 3.74	3.43 / 3.63
Inrush current		5	5	5
Max. current		14	14	14
Sound power level*1	Indoor	Cooling/Heating 64 / 64	64 / 64	65 / 65
	Outdoor	Cooling/Heating 67 / 67	68 / 70	69 / 71
Sound pressure level*1	Indoor	Cooling (P-Hi/Hi/Me/Lo) dB(A) 48 / 43 / 38 / 34	48 / 45 / 40 / 35	49 / 45 / 40 / 36
		Heating (P-Hi/Hi/Me/Lo) 48 / 43 / 38 / 34	48 / 45 / 40 / 35	49 / 45 / 40 / 36
	Outdoor	Cooling/Heating 53 / 51	53 / 54	54 / 54
		Cooling (P-Hi/Hi/Me/Lo) m³/min 32 / 26 / 21 / 16.5	32 / 29 / 23 / 17	34 / 29 / 23 / 18
Air flow	Heating (P-Hi/Hi/Me/Lo) 32 / 26 / 21 / 16.5	32 / 29 / 23 / 17	34 / 29 / 23 / 18	
	Outdoor	Cooling/Heating 100 / 100	100 / 100	100 / 100
Exterior dimensions	Indoor	HeightxWidthxDepth mm 250 x 1,620 x 690		
	Outdoor	1,300 x 970 x 370		
Net weight	Indoor	43		
	Outdoor	99		
Ref.piping size	Liquid/Gas	ømm 9.52(3/8") / 15.88(5/8")		
Refrigerant line (one way) length		m	Max. 100	
Vertical height differences		Outdoor is higher/lower m	Max.50 / Max.15	
Outdoor operating temperature range	Cooling	°CDB	-15~50*2	
	Heating	°CWB	-20~20	
Air filter, Q'ty		Pocket Plastic net x2(Washable)		
Remote control (option)		wired:RC-EX3A, RC-E5, RCH-E3 wireless:RCN-E-E3		

The values are for simultaneous Multi operation.

R32		Hyper Inverter				
Set model name		FDE71VNXWPVH	FDE100VNXWPVH	FDE125VNXWPVH	FDE140VNXWPVH	FDE140VNXWTVH
Indoor unit		FDE40VH x 2	FDE50VH x 2	FDE60VH x 2	FDE71VH x 2	FDE50VH x 3
Outdoor unit		FDC71VNX-W	FDC100VNX-W	FDC125VNX-W	FDC140VNX-W	FDC140VNX-W
Power source		1 Phase 220-240V, 50Hz / 220V, 60Hz				
Nominal cooling capacity (Min~Max)		kW 7.1 (3.2 ~ 8.0)	10.0 (3.5 ~ 11.2)	12.5 (3.5 ~ 14.0)	14.0 (3.5 ~ 16.0)	14.0 (3.5 ~ 16.0)
Nominal heating capacity (Min~Max)		kW 8.0 (3.6 ~ 9.0)	11.2 (2.7 ~ 12.5)	14.0 (2.7 ~ 17.0)	16.0 (2.7 ~ 18.0)	16.0 (2.7 ~ 18.0)
Power consumption		Cooling/Heating kW 1.76 / 2.10	2.48 / 2.88	3.49 / 3.27	4.16 / 3.97	3.72 / 4.11
EER/COP		Cooling/Heating 4.03 / 3.81	4.04 / 3.89	3.58 / 4.29	3.36 / 4.03	3.76 / 3.89
Inrush current		5	5	5	5	5
Max. current		19.1	25	27	27	27
Sound power level*1	Indoor*3	Cooling/Heating 60 / 60	60 / 60	60 / 60	60 / 60	60 / 60
	Outdoor	Cooling/Heating 66 / 66	67 / 67	68 / 70	69 / 71	69 / 71
Sound pressure level*1	Indoor*3	Cooling (P-Hi/Hi/Me/Lo) dB(A) 46 / 38 / 36 / 31	46 / 38 / 36 / 31	47 / 41 / 37 / 32	47 / 41 / 37 / 32	46 / 38 / 36 / 31
		Heating (P-Hi/Hi/Me/Lo) 46 / 38 / 36 / 31	46 / 38 / 36 / 31	47 / 41 / 37 / 32	47 / 41 / 37 / 32	46 / 38 / 36 / 31
	Outdoor	Cooling/Heating 51 / 51	53 / 51	53 / 54	54 / 54	54 / 54
		Cooling (P-Hi/Hi/Me/Lo) m³/min 13 / 10 / 9 / 7	13 / 10 / 9 / 7	20 / 16 / 13 / 10	20 / 16 / 13 / 10	13 / 10 / 9 / 7
Air flow	Heating (P-Hi/Hi/Me/Lo) 13 / 10 / 9 / 7	13 / 10 / 9 / 7	20 / 16 / 13 / 10	20 / 16 / 13 / 10	13 / 10 / 9 / 7	
	Outdoor	Cooling/Heating 60 / 50	100 / 100	100 / 100	100 / 100	100 / 100
Exterior dimensions	Indoor	HeightxWidthxDepth mm 210 x 1,070 x 690	210 x 1,320 x 690		210 x 1,070 x 690	
	Outdoor	750 x 880(+88) x 340	1,300 x 970 x 370			
Net weight	Indoor	28	33		28	
	Outdoor	60	97			
Ref.piping size	Liquid/Gas	ømm 9.52(3/8") / 15.88(5/8")				
Refrigerant line (one way) length		m Max. 50	Max. 100		Max. 85	
Vertical height differences		Outdoor is higher/lower m	Max.30 / Max.15		Max.50 / Max.15	
Outdoor operating temperature range	Cooling	°CDB	-15~50*2			
	Heating	°CWB	-20~20			
Air filter, Q'ty		Pocket plastic net x 2(Washable)				
Remote control (option)		wired:RC-EX3A, RC-E5, RCH-E3 wireless:RCN-E-E3				

### NOTES:

The data are measured under the following conditions(R32 : ISO-T1, -H1 / R410A : ISO-T1).

Cooling:Indoor temp. of 27°CDB, 19°CWB, and outdoor temp. of 35°CDB. Heating:Indoor temp. of 20°CDB, and outdoor temp. of 7°CDB, 6°CWB.

\*1 : Indicates the value in an anechoic chamber. During operation these values are somewhat higher due to ambient conditions.

\*2 : If a cooling operation is conducted when the outdoor air temperature is -5°C or lower, the outdoor unit should be installed at a place where it is not influenced by natural wind. If wind blows, the low pressure will drop and compressor frequency will increase, this will cause the capacity to drop and may cause the unit to break down.

\*3 : The values are for one indoor unit operation. (Multi system only)

The values are for simultaneous Multi operation.

R32			Hyper Inverter			
Set model name			FDE100VSXWPVH	FDE125VSXWPVH	FDE140VSXWPVH	FDE140VSXWTVH
			Twin		Triple	
Indoor unit			FDE50VH x 2	FDE60VH x 2	FDE71VH x 2	FDE50VH x 3
Outdoor unit			FDC100VSX-W	FDC125VSX-W	FDC140VSX-W	FDC140VSX-W
Power source			3 Phase 380-415V, 50Hz / 380V, 60Hz			
Nominal cooling capacity (Min~Max)	kW		10.0 ( 3.5 ~ 11.2 )	12.5 ( 3.5 ~ 14.0 )	14.0 ( 3.5 ~ 16.0 )	14.0 ( 3.5 ~ 16.0 )
Nominal heating capacity (Min~Max)	kW		11.2 ( 2.7 ~ 16.0 )	14.0 ( 2.7 ~ 18.0 )	16.0 ( 2.7 ~ 20.0 )	16.0 ( 2.7 ~ 20.0 )
Power consumption	Cooling/Heating	kW	2.48 / 2.88	3.49 / 3.27	4.16 / 3.97	3.72 / 4.11
EER/COP	Cooling/Heating		4.04 / 3.89	3.58 / 4.29	3.36 / 4.03	3.76 / 3.89
Inrush current		A	5	5	5	5
Max. current			14	14	14	14
Sound power level*1	Indoor*3	Cooling/Heating	60 / 60	60 / 60	60 / 60	60 / 60
	Outdoor	Cooling/Heating	67 / 67	68 / 70	69 / 71	69 / 71
Sound pressure level*1	Indoor*3	Cooling (P-Hi/Hi/Me/Lo)	46 / 38 / 36 / 31	47 / 41 / 37 / 32	47 / 41 / 37 / 32	46 / 38 / 36 / 31
	Outdoor	Cooling/Heating	53 / 51	53 / 54	54 / 54	54 / 54
Air flow	Indoor*3	Cooling (P-Hi/Hi/Me/Lo)	13 / 10 / 9 / 7	20 / 16 / 13 / 10	20 / 16 / 13 / 10	13 / 10 / 9 / 7
	Outdoor	Cooling/Heating	100 / 100	100 / 100	100 / 100	100 / 100
Exterior dimensions	Indoor	HeightxWidthxDepth	210 x 1,070 x 690	210 x 1,320 x 690		210 x 1,070 x 690
	Outdoor			1,300 x 970 x 370		
Net weight	Indoor		28	33		28
	Outdoor			99		
Ref.piping size	Liquid/Gas	ømm	9.52(3/8") / 15.88(5/8")			
Refrigerant line (one way) length		m	Max.100		Max.85	
Vertical height differences	Outdoor is higher/lower	m	Max.50 / Max.15			
Outdoor operating temperature range	Cooling	°CDB	-15~50*2			
	Heating	°CWB	-20~20			
Air filter, Q'ty			Pocket plastic net x 2(Washable)			
Remote control (option)			wired:RC-EX3A, RC-E5, RCH-E3 wireless:RCN-E-E3			

R410A			Hyper Inverter			
Set model name			FDE40ZSXVH	FDE50ZSXVH	FDE60ZSXVH	
Indoor unit			FDE40VH	FDE50VH	FDE60VH	
Outdoor unit			SRC40ZSX-S	SRC50ZSX-S	SRC60ZSX-S	
Power source			1 Phase 220-240V, 50Hz / 220V, 60Hz			
Nominal cooling capacity (Min~Max)	kW		4.0 ( 1.1 ~ 4.7 )	5.0 ( 1.1 ~ 5.6 )	5.6 ( 1.1 ~ 6.3 )	
Nominal heating capacity (Min~Max)	kW		4.5 ( 0.6 ~ 5.4 )	5.4 ( 0.6 ~ 6.3 )	6.7 ( 0.6 ~ 7.1 )	
Power consumption	Cooling/Heating	kW	1.02 / 1.10	1.52 / 1.46	1.75 / 1.86	
EER/COP	Cooling/Heating		3.92 / 4.09	3.29 / 3.70	3.20 / 3.60	
Inrush current		A	5	5	5	
Max. current			12	15	15	
Sound power level*1	Indoor	Cooling/Heating	60 / 60	60 / 60	60 / 60	
	Outdoor	Cooling/Heating	63 / 63	63 / 63	65 / 64	
Sound pressure level*1	Indoor	Cooling (P-Hi/Hi/Me/Lo)	46 / 38 / 36 / 31	46 / 38 / 36 / 31	47 / 41 / 37 / 32	
	Outdoor	Cooling/Heating	50 / 49	50 / 49	52 / 52	
Air flow	Indoor	Cooling (P-Hi/Hi/Me/Lo)	13 / 10 / 9 / 7	13 / 10 / 9 / 7	20 / 16 / 13 / 10	
	Outdoor	Cooling/Heating	36 / 33	40 / 33	41.5 / 39	
Exterior dimensions	Indoor	HeightxWidthxDepth	210 x 1,070 x 690			210 x 1,320 x 690
	Outdoor		640 x 800(+71) x 290			
Net weight	Indoor		28		33	
	Outdoor		45			
Ref.piping size	Liquid/Gas	ømm	6.35(1/4") / 12.7(1/2")			
Refrigerant line (one way) length		m	Max.30			
Vertical height differences	Outdoor is higher/lower	m	Max.20 / Max.20			
Outdoor operating temperature range	Cooling	°CDB	-15~46*2			
	Heating	°CWB	-20~24			
Air filter, Q'ty			Pocket Plastic net x2(Washable)			
Remote control (option)			wired:RC-EX3A, RC-E5, RCH-E3 wireless:RCN-E-E3			

## SPECIFICATIONS - FDE -

R410A		Hyper Inverter			
Set model name		FDE71VNXVH	FDE100VNXVH	FDE125VNXVH	FDE140VNXVH
Indoor unit		FDE71VH	FDE100VH	FDE125VH	FDE140VH
Outdoor unit		FDC71VNX	FDC100VNX	FDC125VNX	FDC140VNX
Power source		1 Phase 220-240V, 50Hz / 220V, 60Hz			
Nominal cooling capacity (Min~Max)		kW 7.1 (3.2 ~ 8.0)	10.0 (4.0 ~ 11.2)	12.5 (5.0 ~ 14.0)	14.0 (5.0 ~ 16.0)
Nominal heating capacity (Min~Max)		kW 8.0 (3.6 ~ 9.0)	11.2 (4.0 ~ 12.5)	14.0 (4.0 ~ 17.0)	16.0 (4.0 ~ 18.0)
Power consumption		Cooling/Heating kW 2.11 / 2.11	2.55 / 2.68	3.50 / 3.77	4.40 / 4.69
EER/COP		Cooling/Heating 3.36 / 3.79	3.92 / 4.18	3.57 / 3.71	3.18 / 3.41
Inrush current		A 5	5	5	5
Max. current		A 17	24	26	26
Sound power level*1	Indoor	Cooling/Heating	60 / 60	64 / 64	64 / 64
	Outdoor	Cooling/Heating	66 / 66	70 / 70	70 / 70
Sound pressure level*1	Indoor	Cooling (P-Hi/Hi/Me/Lo)	47 / 41 / 37 / 32	48 / 43 / 38 / 34	48 / 45 / 40 / 35
		Heating (P-Hi/Hi/Me/Lo)	47 / 41 / 37 / 32	48 / 43 / 38 / 34	48 / 45 / 40 / 35
	Outdoor	Cooling/Heating	51 / 48	48 / 50	48 / 50
		Cooling/Heating	51 / 48	48 / 50	48 / 50
Air flow	Indoor	Cooling (P-Hi/Hi/Me/Lo)	m <sup>3</sup> /min 20 / 16 / 13 / 10	32 / 26 / 21 / 16.5	32 / 29 / 23 / 17
		Heating (P-Hi/Hi/Me/Lo)	20 / 16 / 13 / 10	32 / 26 / 21 / 16.5	32 / 29 / 23 / 17
	Outdoor	Cooling/Heating	60 / 50	100 / 100	100 / 100
Exterior dimensions	Indoor	HeightxWidthxDepth	mm 210 x 1,320 x 690	250 x 1,620 x 690	
	Outdoor	HeightxWidthxDepth	750 x 880(+88) x 340	1,300 x 970 x 370	
Net weight	Indoor		kg 33	43	
	Outdoor		60	105	
Ref.piping size		Liquid/Gas	ømm 9.52(3/8") / 15.88(5/8")		
Refrigerant line (one way) length		m	Max.50	Max.100	
Vertical height differences		Outdoor is higher/lower	m Max.30 / Max.15		
Outdoor operating temperature range	Cooling	°CDB	-15~43*2		
	Heating	°CWB	-20~20		
Air filter, Q'ty			Pocket Plastic net x2(Washable)		
Remote control (option)			wired:RC-EX3A, RC-E5, RCH-E3 wireless:RCN-E-E3		

R410A		Hyper Inverter			
Set model name		FDE100VSXVH	FDE125VSXVH	FDE140VSXVH	
Indoor unit		FDE100VH	FDE125VH	FDE140VH	
Outdoor unit		FDC100VSX	FDC125VSX	FDC140VSX	
Power source		3 Phase 380-415V, 50Hz / 380V, 60Hz			
Nominal cooling capacity (Min~Max)		kW 10.0 (4.0 ~ 11.2)	12.5 (5.0 ~ 14.0)	14.0 (5.0 ~ 16.0)	
Nominal heating capacity (Min~Max)		kW 11.2 (4.0 ~ 16.0)	14.0 (4.0 ~ 18.0)	16.0 (4.0 ~ 20.0)	
Power consumption		Cooling/Heating kW 2.55 / 2.68	3.50 / 3.77	4.40 / 4.69	
EER/COP		Cooling/Heating 3.92 / 4.18	3.57 / 3.71	3.18 / 3.41	
Inrush current		A 5	5	5	
Max. current		A 15	15	15	
Sound power level*1	Indoor	Cooling/Heating	64 / 64	64 / 64	65 / 65
	Outdoor	Cooling/Heating	70 / 70	70 / 70	72 / 72
Sound pressure level*1	Indoor	Cooling (P-Hi/Hi/Me/Lo)	48 / 43 / 38 / 34	48 / 45 / 40 / 35	49 / 45 / 40 / 36
		Heating (P-Hi/Hi/Me/Lo)	48 / 43 / 38 / 34	48 / 45 / 40 / 35	49 / 45 / 40 / 36
	Outdoor	Cooling/Heating	48 / 50	48 / 50	49 / 52
		Cooling/Heating	48 / 50	48 / 50	49 / 52
Air flow	Indoor	Cooling (P-Hi/Hi/Me/Lo)	m <sup>3</sup> /min 32 / 26 / 21 / 16.5	32 / 29 / 23 / 17	34 / 29 / 23 / 18
		Heating (P-Hi/Hi/Me/Lo)	32 / 26 / 21 / 16.5	32 / 29 / 23 / 17	34 / 29 / 23 / 18
	Outdoor	Cooling/Heating	100 / 100	100 / 100	100 / 100
Exterior dimensions	Indoor	HeightxWidthxDepth	mm 250 x 1,620 x 690		
	Outdoor	HeightxWidthxDepth	1,300 x 970 x 370		
Net weight	Indoor		kg 43		
	Outdoor		105		
Ref.piping size		Liquid/Gas	ømm 9.52(3/8") / 15.88(5/8")		
Refrigerant line (one way) length		m	Max.100		
Vertical height differences		Outdoor is higher/lower	m Max.30 / Max.15		
Outdoor operating temperature range	Cooling	°CDB	-15~43*2		
	Heating	°CWB	-20~20		
Air filter, Q'ty			Pocket Plastic net x2(Washable)		
Remote control (option)			wired:RC-EX3A, RC-E5, RCH-E3 wireless:RCN-E-E3		

### NOTES:

The data are measured under the following conditions(ISO-T1).

Cooling:Indoor temp. of 27°CDB, 19°CWB, and outdoor temp. of 35°CDB. Heating:Indoor temp. of 20°CDB, and outdoor temp. of 7°CDB, 6°CWB.

\*1 : Indicates the value in an anechoic chamber. During operation these values are somewhat higher due to ambient conditions.

\*2 : If a cooling operation is conducted when the outdoor air temperature is -5°C or lower, the outdoor unit should be installed at a place where it is not influenced by natural wind. If wind blows, the low pressure will drop and compressor frequency will increase, this will cause the capacity to drop and may cause the unit to break down.

\*3 : The values are for one indoor unit operation. (Multi system only)



The values are for simultaneous Multi operation.

R410A			Hyper Inverter				
Set model name			FDE71VNXPVH	FDE100VNXPVH	FDE125VNXPVH	FDE140VNXPVH	FDE140VNXTVH
			Twin				Triple
Indoor unit			FDE40VH x 2	FDE50VH x 2	FDE60VH x 2	FDE71VH x 2	FDE50VH x 3
Outdoor unit			FDC71VNX	FDC100VNX	FDC125VNX	FDC140VNX	FDC140VNX
Power source			1 Phase 220-240V, 50Hz / 220V, 60Hz				
Nominal cooling capacity (Min~Max)			kW 7.1 (3.2 ~ 8.0)	10.0 (4.0 ~ 11.2)	12.5 (5.0 ~ 14.0)	14.0 (5.0 ~ 16.0)	14.0 (5.0 ~ 16.0)
Nominal heating capacity (Min~Max)			kW 8.0 (3.6 ~ 9.0)	11.2 (4.0 ~ 12.5)	14.0 (4.0 ~ 17.0)	16.0 (4.0 ~ 18.0)	16.0 (4.0 ~ 18.0)
Power consumption			Cooling/Heating kW 2.05 / 2.35	3.00 / 3.39	3.97 / 3.70	4.67 / 4.58	4.66 / 4.53
EER/COP			Cooling/Heating 3.46 / 3.40	3.33 / 3.30	3.15 / 3.78	3.00 / 3.49	3.00 / 3.53
Inrush current			A 5	5	5	5	5
Max. current			17	24	26	26	26
Sound power level*1	Indoor*3	Cooling/Heating	60 / 60	60 / 60	60 / 60	60 / 60	60 / 60
	Outdoor	Cooling/Heating	66 / 66	70 / 70	70 / 70	72 / 72	72 / 72
Sound pressure level*1	Indoor*3	Cooling (P-Hi/Hi/Me/Lo)	46 / 38 / 36 / 31	46 / 38 / 36 / 31	47 / 41 / 37 / 32	47 / 41 / 37 / 32	46 / 38 / 36 / 31
		Heating (P-Hi/Hi/Me/Lo)	46 / 38 / 36 / 31	46 / 38 / 36 / 31	47 / 41 / 37 / 32	47 / 41 / 37 / 32	46 / 38 / 36 / 31
	Outdoor	Cooling/Heating	51 / 48	48 / 50	48 / 50	49 / 52	49 / 52
Air flow	Indoor*3	Cooling (P-Hi/Hi/Me/Lo)	13 / 10 / 9 / 7	13 / 10 / 9 / 7	20 / 16 / 13 / 10	20 / 16 / 13 / 10	13 / 10 / 9 / 7
		Heating (P-Hi/Hi/Me/Lo)	13 / 10 / 9 / 7	13 / 10 / 9 / 7	20 / 16 / 13 / 10	20 / 16 / 13 / 10	13 / 10 / 9 / 7
	Outdoor	Cooling/Heating	60 / 50	100 / 100	100 / 100	100 / 100	100 / 100
Exterior dimensions	Indoor	HeightxWidthxDepth	210 x 1,070 x 690		210 x 1,320 x 690		210 x 1,070 x 690
	Outdoor		750 x 880(+88) x 340		1,300 x 970 x 370		
Net weight	Indoor		28		33		28
	Outdoor		60		105		
Ref.piping size	Liquid/Gas	ømm	9.52(3/8") / 15.88(5/8")				
Refrigerant line (one way) length		m	Max. 50		Max. 100		
Vertical height differences	Outdoor is higher/lower	m	Max.30 / Max.15				
Outdoor operating temperature range	Cooling	°CDB	-15~43*2				
	Heating	°CWB	-20~20				
Air filter, Q'ty			Pocket plastic net x 2(Washable)				
Remote control (option)			wired:RC-EX3A, RC-E5, RCH-E3 wireless:RCN-E-E3				

The values are for simultaneous Multi operation.

R410A			Hyper Inverter			
Set model name			FDE100VSXPVH	FDE125VSXPVH	FDE140VSXPVH	FDE140VSXTVH
			Twin			Triple
Indoor unit			FDE50VH x 2	FDE60VH x 2	FDE71VH x 2	FDE50VH x 3
Outdoor unit			FDC100VSX	FDC125VSX	FDC140VSX	FDC140VSX
Power source			3 Phase 380-415V, 50Hz / 380V, 60Hz			
Nominal cooling capacity (Min~Max)			kW 10.0 (4.0 ~ 11.2)	12.5 (5.0 ~ 14.0)	14.0 (5.0 ~ 16.0)	14.0 (5.0 ~ 16.0)
Nominal heating capacity (Min~Max)			kW 11.2 (4.0 ~ 16.0)	14.0 (4.0 ~ 18.0)	16.0 (4.0 ~ 20.0)	16.0 (4.0 ~ 20.0)
Power consumption			Cooling/Heating kW 3.00 / 3.39	3.97 / 3.70	4.67 / 4.58	4.66 / 4.53
EER/COP			Cooling/Heating 3.33 / 3.30	3.15 / 3.78	3.00 / 3.49	3.00 / 3.53
Inrush current			A 5	5	5	5
Max. current			15	15	15	15
Sound power level*1	Indoor*3	Cooling/Heating	60 / 60	60 / 60	60 / 60	60 / 60
	Outdoor	Cooling/Heating	70 / 70	70 / 70	72 / 72	72 / 72
Sound pressure level*1	Indoor*3	Cooling (P-Hi/Hi/Me/Lo)	46 / 38 / 36 / 31	47 / 41 / 37 / 32	47 / 41 / 37 / 32	46 / 38 / 36 / 31
		Heating (P-Hi/Hi/Me/Lo)	46 / 38 / 36 / 31	47 / 41 / 37 / 32	47 / 41 / 37 / 32	46 / 38 / 36 / 31
	Outdoor	Cooling/Heating	48 / 50	48 / 50	49 / 52	49 / 52
Air flow	Indoor*3	Cooling (P-Hi/Hi/Me/Lo)	13 / 10 / 9 / 7	20 / 16 / 13 / 10	20 / 16 / 13 / 10	13 / 10 / 9 / 7
		Heating (P-Hi/Hi/Me/Lo)	13 / 10 / 9 / 7	20 / 16 / 13 / 10	20 / 16 / 13 / 10	13 / 10 / 9 / 7
	Outdoor	Cooling/Heating	100 / 100	100 / 100	100 / 100	100 / 100
Exterior dimensions	Indoor	HeightxWidthxDepth	210 x 1,070 x 690		210 x 1,320 x 690	
	Outdoor				1,300 x 970 x 370	
Net weight	Indoor		28		33	
	Outdoor		60		105	
Ref.piping size	Liquid/Gas	ømm	9.52(3/8") / 15.88(5/8")			
Refrigerant line (one way) length		m	Max.100			
Vertical height differences	Outdoor is higher/lower	m	Max.30 / Max.15			
Outdoor operating temperature range	Cooling	°CDB	-15~43*2			
	Heating	°CWB	-20~20			
Air filter, Q'ty			Pocket plastic net x 2(Washable)			
Remote control (option)			wired:RC-EX3A, RC-E5, RCH-E3 wireless:RCN-E-E3			

## SPECIFICATIONS - FDE -

R32		Micro Inverter		
Set model name		FDE100VNAVWH	FDE125VNAVWH	FDE140VNAVWH
Indoor unit		FDE100VH	FDE125VH	FDE140VH
Outdoor unit		FDC100VNA-W	FDC125VNA-W	FDC140VNA-W
Power source		1 Phase 220-240V, 50Hz / 220V, 60Hz		
Nominal cooling capacity (Min-Max)	kW	10.0 ( 4.0 ~ 11.2 )	12.5 ( 5.0 ~ 14.0 )	13.6 ( 5.0 ~ 14.5 )
Nominal heating capacity (Min-Max)	kW	11.2 ( 4.0 ~ 12.5 )	14.0 ( 4.0 ~ 16.0 )	15.5 ( 4.0 ~ 16.5 )
Power consumption	Cooling/Heating	2.85 / 2.54	4.45 / 3.74	5.05 / 4.18
EER/COP	Cooling/Heating	3.51 / 4.41	2.81 / 3.74	2.69 / 3.71
Inrush current		5	5	5
Max. current		24	24	24
Sound power level*1	Indoor	Cooling/Heating	64 / 64	65 / 65
	Outdoor	Cooling/Heating	69 / 70	72 / 73
Sound pressure level*1	Indoor	Cooling (P-Hi/Hi/Me/Lo)	48 / 43 / 38 / 34	49 / 45 / 40 / 36
		Heating (P-Hi/Hi/Me/Lo)	48 / 43 / 38 / 34	49 / 45 / 40 / 36
	Outdoor	Cooling/Heating	54 / 55	56 / 58
Air flow	Indoor	Cooling (P-Hi/Hi/Me/Lo)	32 / 26 / 21 / 16.5	34 / 29 / 23 / 18
		Heating (P-Hi/Hi/Me/Lo)	32 / 26 / 21 / 16.5	34 / 29 / 23 / 18
	Outdoor	Cooling/Heating	75 / 73	75 / 73
Exterior dimensions	Indoor	HeightxWidthxDepth	250 x 1,620 x 690	
	Outdoor		845 x 970 x 370	
Net weight	Indoor		43	
	Outdoor		77	
Ref.piping size	Liquid/Gas	ømm	9.52(3/8") / 15.88(5/8")	
Refrigerant line (one way) length		m	Max.50	
Vertical height differences	Outdoor is higher/lower	m	Max.50 / Max.15	
Outdoor operating temperature range	Cooling	°CDB	-15~50*2	
	Heating	°CWB	-20~20	
Air filter, Q'ty			Pocket Plastic net x2(Washable)	
Remote control (option)			wired:RC-EX3A, RC-E5, RCH-E3 wireless:RCN-E-E3	

R32		Micro Inverter		
Set model name		FDE100VSAVWH	FDE125VSAVWH	FDE140VSAVWH
Indoor unit		FDE100VH	FDE125VH	FDE140VH
Outdoor unit		FDC100VSA-W	FDC125VSA-W	FDC140VSA-W
Power source		3 Phase 380-415V, 50Hz / 380V, 60Hz		
Nominal cooling capacity (Min-Max)	kW	10.0 ( 4.0 ~ 11.2 )	12.5 ( 5.0 ~ 14.0 )	13.6 ( 5.0 ~ 14.5 )
Nominal heating capacity (Min-Max)	kW	11.2 ( 4.0 ~ 12.5 )	14.0 ( 4.0 ~ 16.0 )	15.5 ( 4.0 ~ 16.5 )
Power consumption	Cooling/Heating	2.85 / 2.54	4.45 / 3.74	5.05 / 4.18
EER/COP	Cooling/Heating	3.51 / 4.41	2.81 / 3.74	2.69 / 3.71
Inrush current		5	5	5
Max. current		15	15	15
Sound power level*1	Indoor	Cooling/Heating	64 / 64	65 / 65
	Outdoor	Cooling/Heating	69 / 70	72 / 73
Sound pressure level*1	Indoor	Cooling (P-Hi/Hi/Me/Lo)	48 / 43 / 38 / 34	49 / 45 / 40 / 36
		Heating (P-Hi/Hi/Me/Lo)	48 / 43 / 38 / 34	49 / 45 / 40 / 36
	Outdoor	Cooling/Heating	54 / 55	56 / 58
Air flow	Indoor	Cooling (P-Hi/Hi/Me/Lo)	32 / 26 / 21 / 16.5	34 / 29 / 23 / 18
		Heating (P-Hi/Hi/Me/Lo)	32 / 26 / 21 / 16.5	34 / 29 / 23 / 18
	Outdoor	Cooling/Heating	75 / 73	75 / 73
Exterior dimensions	Indoor	HeightxWidthxDepth	250 x 1,620 x 690	
	Outdoor		845 x 970 x 370	
Net weight	Indoor		43	
	Outdoor		78	
Ref.piping size	Liquid/Gas	ømm	9.52(3/8") / 15.88(5/8")	
Refrigerant line (one way) length		m	Max.50	
Vertical height differences	Outdoor is higher/lower	m	Max.50 / Max.15	
Outdoor operating temperature range	Cooling	°CDB	-15~50*2	
	Heating	°CWB	-20~20	
Air filter, Q'ty			Pocket Plastic net x2(Washable)	
Remote control (option)			wired:RC-EX3A, RC-E5, RCH-E3 wireless:RCN-E-E3	

### NOTES:

The data are measured under the following conditions(ISO-T1, -H1).

Cooling:Indoor temp. of 27°CDB, 19°CWB, and outdoor temp. of 35°CDB. Heating:Indoor temp. of 20°CDB, and outdoor temp. of 7°CDB, 6°CWB.

\*1 : Indicates the value in an anechoic chamber. During operation these values are somewhat higher due to ambient conditions.

\*2 : If a cooling operation is conducted when the outdoor air temperature is -5°C or lower, the outdoor unit should be installed at a place where it is not influenced by natural wind. If wind blows, the low pressure will drop and compressor frequency will increase, this will cause the capacity to drop and may cause the unit to break down.

\*3 : The values are for one indoor unit operation. (Multi system only)

The values are for simultaneous Multi operation.

R32			Micro Inverter			
Set model name			FDE100VNAVPVH	FDE125VNAVPVH	FDE140VNAVPVH	FDE140VNAWTVH
			Twin		Triple	
Indoor unit			FDE50VH x 2	FDE60VH x 2	FDE71VH x 2	FDE50VH x 3
Outdoor unit			FDC100VNA-W	FDC125VNA-W	FDC140VNA-W	FDC140VNA-W
Power source			1 Phase 220-240V, 50Hz / 220V, 60Hz			
Nominal cooling capacity (Min~Max)	kW		10.0 (4.0 ~ 11.2)	12.5 (5.0 ~ 14.0)	13.6 (5.0 ~ 14.5)	13.6 (5.0 ~ 14.5)
Nominal heating capacity (Min~Max)	kW		11.2 (4.0 ~ 12.5)	14.0 (4.0 ~ 16.0)	15.5 (4.0 ~ 16.5)	15.5 (4.0 ~ 16.5)
Power consumption	Cooling/Heating	kW	3.12 / 2.99	4.16 / 3.54	4.74 / 4.21	4.74 / 4.21
EER/COP	Cooling/Heating		3.21 / 3.75	3.00 / 3.95	2.87 / 3.68	2.87 / 3.68
Inrush current		A	5	5	5	5
Max. current			24	24	24	24
Sound power level*1	Indoor <sup>3</sup>	Cooling/Heating	60 / 60	60 / 60	60 / 60	60 / 60
	Outdoor	Cooling/Heating	69 / 70	71 / 71	72 / 73	72 / 73
Sound pressure level*1	Indoor <sup>3</sup>	Cooling (P-Hi/Hi/Me/Lo)	46 / 38 / 36 / 31	47 / 41 / 37 / 32	47 / 41 / 37 / 32	46 / 38 / 36 / 31
	Outdoor	Heating (P-Hi/Hi/Me/Lo)	46 / 38 / 36 / 31	47 / 41 / 37 / 32	47 / 41 / 37 / 32	46 / 38 / 36 / 31
Air flow	Indoor <sup>3</sup>	Cooling/Heating	54 / 55	54 / 56	56 / 58	56 / 58
	Outdoor	Cooling (P-Hi/Hi/Me/Lo)	13 / 10 / 9 / 7	20 / 16 / 13 / 10	20 / 16 / 13 / 10	13 / 10 / 9 / 7
Exterior dimensions	Indoor	HeightxWidthxDepth	210 x 1,070 x 690	210 x 1,320 x 690		210 x 1,070 x 690
	Outdoor			845 x 970 x 370		
Net weight	Indoor		28	33		28
	Outdoor			77		
Ref.piping size	Liquid/Gas	ømm	9.52(3/8") / 15.88(5/8")			
Refrigerant line (one way) length		m	Max. 50			
Vertical height differences	Outdoor is higher/lower	m	Max.50 / Max.15			
Outdoor operating temperature range	Cooling	°CDB	-15~50*2			
	Heating	°CWB	-20~20			
Air filter, Q'ty			Pocket plastic net x 2(Washable)			
Remote control (option)			wired:RC-EX3A, RC-E5, RCH-E3 wireless:RCN-E-E3			

The values are for simultaneous Multi operation.

R32			Micro Inverter			
Set model name			FDE100VSAVPVH	FDE125VSAVPVH	FDE140VSAVPVH	FDE140VSAWTVH
			Twin		Triple	
Indoor unit			FDE50VH x 2	FDE60VH x 2	FDE71VH x 2	FDE50VH x 3
Outdoor unit			FDC100VSA-W	FDC125VSA-W	FDC140VSA-W	FDC140VSA-W
Power source			3 Phase 380-415V, 50Hz / 380V, 60Hz			
Nominal cooling capacity (Min~Max)	kW		10.0 (4.0 ~ 11.2)	12.5 (5.0 ~ 14.0)	13.6 (5.0 ~ 14.5)	13.6 (5.0 ~ 14.5)
Nominal heating capacity (Min~Max)	kW		11.2 (4.0 ~ 12.5)	14.0 (4.0 ~ 16.0)	15.5 (4.0 ~ 16.5)	15.5 (4.0 ~ 16.5)
Power consumption	Cooling/Heating	kW	3.12 / 2.99	4.16 / 3.54	4.74 / 4.21	4.74 / 4.21
EER/COP	Cooling/Heating		3.21 / 3.75	3.00 / 3.95	2.87 / 3.68	2.87 / 3.68
Inrush current		A	5	5	5	5
Max. current			15	15	15	15
Sound power level*1	Indoor <sup>3</sup>	Cooling/Heating	60 / 60	60 / 60	60 / 60	60 / 60
	Outdoor	Cooling/Heating	69 / 70	71 / 71	72 / 73	72 / 73
Sound pressure level*1	Indoor <sup>3</sup>	Cooling (P-Hi/Hi/Me/Lo)	46 / 38 / 36 / 31	47 / 41 / 37 / 32	47 / 41 / 37 / 32	46 / 38 / 36 / 31
	Outdoor	Heating (P-Hi/Hi/Me/Lo)	46 / 38 / 36 / 31	47 / 41 / 37 / 32	47 / 41 / 37 / 32	46 / 38 / 36 / 31
Air flow	Indoor <sup>3</sup>	Cooling/Heating	54 / 55	54 / 56	56 / 58	56 / 58
	Outdoor	Cooling (P-Hi/Hi/Me/Lo)	13 / 10 / 9 / 7	20 / 16 / 13 / 10	20 / 16 / 13 / 10	13 / 10 / 9 / 7
Exterior dimensions	Indoor	HeightxWidthxDepth	210 x 1,070 x 690	210 x 1,320 x 690		210 x 1,070 x 690
	Outdoor			845 x 970 x 370		
Net weight	Indoor		28	33		28
	Outdoor			78		
Ref.piping size	Liquid/Gas	ømm	9.52(3/8") / 15.88(5/8")			
Refrigerant line (one way) length		m	Max.50			
Vertical height differences	Outdoor is higher/lower	m	Max.50 / Max.15			
Outdoor operating temperature range	Cooling	°CDB	-15~50*2			
	Heating	°CWB	-20~20			
Air filter, Q'ty			Pocket plastic net x 2(Washable)			
Remote control (option)			wired:RC-EX3A, RC-E5, RCH-E3 wireless:RCN-E-E3			

## SPECIFICATIONS - FDE -

The values are for simultaneous Multi operation.

R32		Micro Inverter			
		FDE200VSAWPVH	FDE250VSAWPVH	FDE280VSAWPVH	FDE200VSAWTVH
Set model name		Twin		Triple	
Indoor unit		FDE100VH x 2	FDE125VH x 2	FDE140VH x 2	FDE71VH x 3
Outdoor unit		FDC200VSA-W	FDC250VSA-W	FDC280VSA-W	FDC200VSA-W
Power source		3 Phase 380-415V, 50Hz / 380V, 60Hz			
Nominal cooling capacity (Min~Max)	kW	20.0 ( 6.7 ~ 22.4 )	25.0 ( 6.7 ~ 28.0 )	27.0 ( 7.1 ~ 31.5 )	20.0 ( 7.5 ~ 22.4 )
Nominal heating capacity (Min~Max)	kW	22.4 ( 6.6 ~ 25.0 )	28.0 ( 5.2 ~ 31.5 )	30.0 ( 5.8 ~ 33.5 )	22.4 ( 6.6 ~ 25.0 )
Power consumption	Cooling/Heating	6.29 / 5.66	8.20 / 7.93	9.31 / 8.98	6.29 / 5.66
EER/COP	Cooling/Heating	3.18 / 3.96	3.05 / 3.53	2.90 / 3.34	3.18 / 3.96
Inrush current		5	5	5	5
Max. current		19	20	20	19
Sound power level*1	Indoor*3	Cooling/Heating	64 / 64	65 / 65	60 / 60
	Outdoor	Cooling/Heating	72 / 74	73 / 75	72 / 74
Sound pressure level*1	Indoor*3	Cooling (P-Hi/Hi/Me/Lo)	48 / 43 / 38 / 34	48 / 45 / 40 / 35	47 / 41 / 37 / 32
	Outdoor	Heating (P-Hi/Hi/Me/Lo)	48 / 43 / 38 / 34	48 / 45 / 40 / 35	47 / 41 / 37 / 32
Air flow	Indoor*3	Cooling/Heating	58 / 59	58 / 62	58 / 59
	Outdoor	Cooling/Heating	32 / 26 / 21 / 16.5	32 / 29 / 23 / 17	34 / 29 / 23 / 18
Exterior dimensions	Indoor	HeightxWidthxDepth	250 x 1,620 x 690		210 x 1,320 x 690
	Outdoor		1,505 x 970 x 370		
Net weight	Indoor		43		33
	Outdoor		144	145	155
Ref.piping size	Liquid/Gas	ømm	9.52(3/8") / 22.22(7/8")	12.7(1/2") / 22.22(7/8")	9.52(3/8") / 22.22(7/8")
Refrigerant line (one way) length		m	Max.70		Max.60
Vertical height differences	Outdoor is higher/lower	m	Max.50*4 / Max.15		
Outdoor operating temperature range	Cooling	°CDB	-15~50*2		
	Heating	°CWB	-20~20		
Air filter, Q'ty			Pocket plastic net x 2(Washable)		
Remote control (option)			wired:RC-EX3A, RC-E5, RCH-E3 wireless:RCN-E-E3		

The values are for simultaneous Multi operation.

R32		Micro Inverter			
		FDE200VSAWDVH	FDE250VSAWDVH	FDE280VSAWDVH	
Set model name		Double Twin			
Indoor unit		FDE50VH x 4	FDE60VH x 4	FDE71VH x 4	
Outdoor unit		FDC200VSA-W	FDC250VSA-W	FDC280VSA-W	
Power source		3 Phase 380-415V, 50Hz / 380V, 60Hz			
Nominal cooling capacity (Min~Max)	kW	20.0 ( 7.8 ~ 22.4 )	25.0 ( 7.8 ~ 28.0 )	27.0 ( 7.5 ~ 31.5 )	
Nominal heating capacity (Min~Max)	kW	22.4 ( 6.6 ~ 25.0 )	28.0 ( 5.2 ~ 31.5 )	30.0 ( 5.8 ~ 33.5 )	
Power consumption	Cooling/Heating	6.29 / 5.66	8.04 / 7.32	9.15 / 8.98	
EER/COP	Cooling/Heating	3.18 / 3.96	3.11 / 3.83	2.95 / 3.34	
Inrush current		5	5	5	
Max. current		19	20	20	
Sound power level*1	Indoor*3	Cooling/Heating	60 / 60	60 / 60	
	Outdoor	Cooling/Heating	72 / 74	73 / 75	
Sound pressure level*1	Indoor*3	Cooling (P-Hi/Hi/Me/Lo)	46 / 38 / 36 / 31	47 / 41 / 37 / 32	
	Outdoor	Heating (P-Hi/Hi/Me/Lo)	46 / 38 / 36 / 31	47 / 41 / 37 / 32	
Air flow	Indoor*3	Cooling/Heating	58 / 59	58 / 62	
	Outdoor	Cooling/Heating	13 / 10 / 9 / 7	20 / 16 / 13 / 10	
Exterior dimensions	Indoor	HeightxWidthxDepth	210 x 1,070 x 690		
	Outdoor		1,505 x 970 x 370		
Net weight	Indoor		28	33	
	Outdoor		144	145	
Ref.piping size	Liquid/Gas	ømm	9.52(3/8") / 22.22(7/8")	12.7(1/2") / 22.22(7/8")	
Refrigerant line (one way) length		m	Max.70		
Vertical height differences	Outdoor is higher/lower	m	Max.50*4 / Max.15		
Outdoor operating temperature range	Cooling	°CDB	-15~50*2		
	Heating	°CWB	-20~20		
Air filter, Q'ty			Pocket plastic net x 2(Washable)		
Remote control (option)			wired:RC-EX3A, RC-E5, RCH-E3 wireless:RCN-E-E3		

### NOTES:

The data are measured under the following conditions(R32 : ISO-T1, -H1 / R410A : ISO-T1).

Cooling:Indoor temp. of 27°CDB, 19°CWB, and outdoor temp. of 35°CDB. Heating:Indoor temp. of 20°CDB, and outdoor temp. of 7°CDB, 6°CWB.

\*1 : Indicates the value in an anechoic chamber. During operation these values are somewhat higher due to ambient conditions.

\*2 : If a cooling operation is conducted when the outdoor air temperature is -5°C or lower, the outdoor unit should be installed at a place where it is not influenced by natural wind. If wind blows, the low pressure will drop and compressor frequency will increase, this will cause the capacity to drop and may cause the unit to break down.

\*3 : The values are for one indoor unit operation. (Multi system only)

\*4 : In case of following conditions:Max.50m(Outdoor unit is higher & Outdoor temperature ≤ 43°C), Max.30m(Outdoor unit is higher & Outdoor temperature > 43°C)

R410A		Micro Inverter					
Set model name		FDE100VNAVH	FDE125VNAVH	FDE140VNAVH	FDE100VSAVH	FDE125VSAVH	FDE140VSAVH
Indoor unit		FDE100VH	FDE125VH	FDE140VH	FDE100VH	FDE125VH	FDE140VH
Outdoor unit		FDC100VNA	FDC125VNA	FDC140VNA	FDC100VSA	FDC125VSA	FDC140VSA
Power source		1 Phase 220-240V, 50Hz / 220V, 60Hz			3 Phase 380-415V, 50Hz / 380V, 60Hz		
Nominal cooling capacity (Min~Max)	kW	10.0 (4.0 ~ 11.2)	12.5 (5.0 ~ 14.0)	13.6 (5.0 ~ 14.5)	10.0 (4.0 ~ 11.2)	12.5 (5.0 ~ 14.0)	13.6 (5.0 ~ 14.5)
Nominal heating capacity (Min~Max)	kW	11.2 (4.0 ~ 12.5)	14.0 (4.0 ~ 16.0)	15.5 (4.0 ~ 16.5)	11.2 (4.0 ~ 12.5)	14.0 (4.0 ~ 16.0)	15.5 (4.0 ~ 16.5)
Power consumption	Cooling/Heating	2.85 / 2.70	4.45 / 3.74	5.21 / 4.42	2.85 / 2.70	4.45 / 3.74	5.21 / 4.42
EER/COP	Cooling/Heating	3.51 / 4.15	2.81 / 3.74	2.61 / 3.51	3.51 / 4.15	2.81 / 3.74	2.61 / 3.51
Inrush current		5	5	5	5	5	5
Max. current		24	24	24	15	15	15
Sound power level*1	Indoor	Cooling/Heating	64 / 64	64 / 64	65 / 65	64 / 64	64 / 64
	Outdoor	Cooling/Heating	70 / 70	71 / 71	73 / 73	70 / 70	71 / 71
Sound pressure level*1	Indoor	Cooling (P-Hi/Hi/Me/Lo)	48 / 43 / 38 / 34	48 / 45 / 40 / 35	49 / 45 / 40 / 36	48 / 43 / 38 / 34	48 / 45 / 40 / 35
		Heating (P-Hi/Hi/Me/Lo)	48 / 43 / 38 / 34	48 / 45 / 40 / 35	49 / 45 / 40 / 36	48 / 43 / 38 / 34	48 / 45 / 40 / 35
	Outdoor	Cooling/Heating	54 / 56	55 / 57	57 / 59	54 / 56	55 / 57
Air flow	Indoor	Cooling (P-Hi/Hi/Me/Lo)	32 / 26 / 21 / 16.5	32 / 29 / 23 / 17	34 / 29 / 23 / 18	32 / 26 / 21 / 16.5	32 / 29 / 23 / 17
		Heating (P-Hi/Hi/Me/Lo)	32 / 26 / 21 / 16.5	32 / 29 / 23 / 17	34 / 29 / 23 / 18	32 / 26 / 21 / 16.5	32 / 29 / 23 / 17
	Outdoor	Cooling/Heating	75 / 73	75 / 73	75 / 73	75 / 73	75 / 73
Exterior dimensions	Indoor	HeightxWidthxDepth	250 x 1,620 x 690				
	Outdoor		845 x 970 x 370				
Net weight	Indoor		43				
	Outdoor		80				82
Ref.piping size	Liquid/Gas	ømm	9.52(3/8") / 15.88(5/8")				
Refrigerant line (one way) length		m	Max.50				
Vertical height differences	Outdoor is higher/lower	m	Max.50 / Max.15				
Outdoor operating temperature range	Cooling	°CDB	-15~50*2				
	Heating	°CWB	-20~20				
Air filter, Q'ty			Pocket Plastic net x2(Washable)				
Remote control (option)			wired:RC-EX3A, RC-E5, RCH-E3 wireless:RCN-E-E3				

The values are for simultaneous Multi operation.

R410A		Micro Inverter			
Set model name		FDE100VNAPVH	FDE125VNAPVH	FDE140VNAPVH	FDE140VNATVH
Indoor unit		FDE50VH x 2	FDE60VH x 2	FDE71VH x 2	FDE50VH x 3
Outdoor unit		FDC100VNA	FDC125VNA	FDC140VNA	FDC140VNA
Power source		1 Phase 220-240V, 50Hz / 220V, 60Hz			
Nominal cooling capacity (Min~Max)	kW	10.0 (4.0 ~ 11.2)	12.5 (5.0 ~ 14.0)	13.6 (5.0 ~ 14.5)	13.6 (5.0 ~ 14.5)
Nominal heating capacity (Min~Max)	kW	11.2 (4.0 ~ 12.5)	14.0 (4.0 ~ 16.0)	15.5 (4.0 ~ 16.5)	15.5 (4.0 ~ 16.5)
Power consumption	Cooling/Heating	3.12 / 2.99	4.16 / 3.54	4.74 / 4.21	4.74 / 4.21
EER/COP	Cooling/Heating	3.21 / 3.75	3.00 / 3.95	2.87 / 3.68	2.87 / 3.68
Inrush current		5	5	5	5
Max. current		24	24	24	24
Sound power level*1	Indoor*3	Cooling/Heating	60 / 60	60 / 60	60 / 60
	Outdoor	Cooling/Heating	70 / 70	71 / 71	73 / 73
Sound pressure level*1	Indoor*3	Cooling (P-Hi/Hi/Me/Lo)	46 / 38 / 36 / 31	47 / 41 / 37 / 32	47 / 41 / 37 / 32
		Heating (P-Hi/Hi/Me/Lo)	46 / 38 / 36 / 31	47 / 41 / 37 / 32	47 / 41 / 37 / 32
	Outdoor	Cooling/Heating	54 / 56	55 / 57	57 / 59
Air flow	Indoor*3	Cooling (P-Hi/Hi/Me/Lo)	13 / 10 / 9 / 7	20 / 16 / 13 / 10	20 / 16 / 13 / 10
		Heating (P-Hi/Hi/Me/Lo)	13 / 10 / 9 / 7	20 / 16 / 13 / 10	20 / 16 / 13 / 10
	Outdoor	Cooling/Heating	75 / 73	75 / 73	75 / 73
Exterior dimensions	Indoor	HeightxWidthxDepth	210 x 1,070 x 690	210 x 1,320 x 690	
	Outdoor		845 x 970 x 370		
Net weight	Indoor		28	33	
	Outdoor		80		
Ref.piping size	Liquid/Gas	ømm	9.52(3/8") / 15.88(5/8")		
Refrigerant line (one way) length		m	Max. 50		
Vertical height differences	Outdoor is higher/lower	m	Max.50 / Max.15		
Outdoor operating temperature range	Cooling	°CDB	-15~50*2		
	Heating	°CWB	-20~20		
Air filter, Q'ty			Pocket plastic net x 2(Washable)		
Remote control (option)			wired:RC-EX3A, RC-E5, RCH-E3 wireless:RCN-E-E3		

# SPECIFICATIONS - FDE -

The values are for simultaneous Multi operation.

R410A			Micro Inverter			
Set model name			FDE100VSAPVH	FDE125VSAPVH	FDE140VSAPVH	FDE140VSATVH
			Twin		Triple	
Indoor unit			FDE50VH x 2	FDE60VH x 2	FDE71VH x 2	FDE50VH x 3
Outdoor unit			FDC100VSA	FDC125VSA	FDC140VSA	FDC140VSA
Power source			3 Phase 380-415V, 50Hz / 380V, 60Hz			
Nominal cooling capacity (Min~Max)	kW		10.0 ( 4.0 ~ 11.2 )	12.5 ( 5.0 ~ 14.0 )	13.6 ( 5.0 ~ 14.5 )	13.6 ( 5.0 ~ 14.5 )
Nominal heating capacity (Min~Max)	kW		11.2 ( 4.0 ~ 12.5 )	14.0 ( 4.0 ~ 16.0 )	15.5 ( 4.0 ~ 16.5 )	15.5 ( 4.0 ~ 16.5 )
Power consumption	Cooling/Heating	kW	3.12 / 2.99	4.16 / 3.54	4.74 / 4.21	4.74 / 4.21
EER/COP	Cooling/Heating		3.21 / 3.75	3.00 / 3.95	2.87 / 3.68	2.87 / 3.68
Inrush current		A	5	5	5	5
Max. current			15	15	15	15
Sound power level*1	Indoor <sup>3</sup>	Cooling/Heating	60 / 60	60 / 60	60 / 60	60 / 60
	Outdoor	Cooling/Heating	70 / 70	71 / 71	73 / 73	73 / 73
Sound pressure level*1	Indoor <sup>3</sup>	Cooling (P-Hi/Hi/Me/Lo)	46 / 38 / 36 / 31	47 / 41 / 37 / 32	47 / 41 / 37 / 32	46 / 38 / 36 / 31
	Outdoor	Cooling/Heating	54 / 56	55 / 57	57 / 59	57 / 59
Air flow	Indoor <sup>3</sup>	Cooling (P-Hi/Hi/Me/Lo)	13 / 10 / 9 / 7	20 / 16 / 13 / 10	20 / 16 / 13 / 10	13 / 10 / 9 / 7
	Outdoor	Cooling/Heating	75 / 73	75 / 73	75 / 73	75 / 73
Exterior dimensions	Indoor	HeightxWidthxDepth	210 x 1,070 x 690	210 x 1,320 x 690		210 x 1,070 x 690
	Outdoor			845 x 970 x 370		
Net weight	Indoor		28	33		28
	Outdoor			82		
Ref.piping size	Liquid/Gas	ømm	9.52(3/8") / 15.88(5/8")			
Refrigerant line (one way) length		m	Max.50			
Vertical height differences	Outdoor is higher/lower	m	Max.50 / Max.15			
Outdoor operating temperature range	Cooling	°CDB	-15~50*2			
	Heating	°CWB	-20~20			
Air filter, Q'ty			Pocket plastic net x 2(Washable)			
Remote control (option)			wired:RC-EX3A, RC-E5, RCH-E3 wireless:RCN-E-E3			

The values are for simultaneous Multi operation.

R410A			Micro Inverter				
Set model name			FDE200VSAPVH	FDE250VSAPVH	FDE200VSATVH	FDE200VSADVH	FDE250VSADVH
			Twin		Triple	Double Twin	
Indoor unit			FDE100VH x 2	FDE125VH x 2	FDE71VH x 3	FDE50VH x 4	FDE60VH x 4
Outdoor unit			FDC200VSA	FDC250VSA	FDC200VSA	FDC200VSA	FDC250VSA
Power source			3 Phase 380-415V, 50Hz / 380V, 60Hz				
Nominal cooling capacity (Min~Max)	kW		19.0 ( 5.2 ~ 22.4 )	24.0 ( 6.9 ~ 28.0 )	19.0 ( 5.2 ~ 22.4 )	19.0 ( 5.2 ~ 22.4 )	24.0 ( 6.9 ~ 28.0 )
Nominal heating capacity (Min~Max)	kW		22.4 ( 3.3 ~ 25.0 )	27.0 ( 5.5 ~ 31.5 )	22.4 ( 3.3 ~ 25.0 )	22.4 ( 3.3 ~ 25.0 )	27.0 ( 5.5 ~ 31.5 )
Power consumption	Cooling/Heating	kW	6.34 / 6.10	8.52 / 7.54	6.33 / 5.94	6.90 / 7.10	8.00 / 7.02
EER/COP	Cooling/Heating		3.00 / 3.67	2.82 / 3.58	3.00 / 3.77	2.75 / 3.15	3.00 / 3.85
Inrush current		A	5	5	5	5	5
Max. current			20	21	20	20	21
Sound power level*1	Indoor <sup>3</sup>	Cooling/Heating	64 / 64	64 / 64	60 / 60	60 / 60	60 / 60
	Outdoor	Cooling/Heating	72 / 74	73 / 75	72 / 74	72 / 74	73 / 75
Sound pressure level*1	Indoor <sup>3</sup>	Cooling (P-Hi/Hi/Me/Lo)	48 / 43 / 38 / 34	48 / 45 / 40 / 35	47 / 41 / 37 / 32	46 / 38 / 36 / 31	47 / 41 / 37 / 32
	Outdoor	Cooling/Heating	58 / 59	59 / 62	58 / 59	58 / 59	59 / 62
Air flow	Indoor <sup>3</sup>	Cooling (P-Hi/Hi/Me/Lo)	32 / 26 / 21 / 16.5	32 / 29 / 23 / 17	20 / 16 / 13 / 10	13 / 10 / 9 / 7	20 / 16 / 13 / 10
	Outdoor	Cooling/Heating	135 / 135	143 / 151	135 / 135	135 / 135	143 / 151
Exterior dimensions	Indoor	HeightxWidthxDepth	250 x 1,620 x 690		210 x 1,320 x 690	210 x 1,070 x 690	210 x 1,320 x 690
	Outdoor		1,300 x 970 x 370	1,505 x 970 x 370	1,300 x 970 x 370	1,300 x 970 x 370	1,505 x 970 x 370
Net weight	Indoor		43		33	28	33
	Outdoor		115	143	115	115	143
Ref.piping size	Liquid/Gas	ømm	9.52(3/8") / 22.22(7/8")	12.7(1/2") / 22.22(7/8")	9.52(3/8") / 22.22(7/8")	9.52(3/8") / 22.22(7/8")	12.7(1/2") / 22.22(7/8")
Refrigerant line (one way) length		m	Max.70				
Vertical height differences	Outdoor is higher/lower	m	Max.30 / Max.15				
Outdoor operating temperature range	Cooling	°CDB	-15~50*2				
	Heating	°CWB	-15~20				
Air filter, Q'ty			Pocket plastic net x 2(Washable)				
Remote control (option)			wired:RC-EX3A, RC-E5, RCH-E3 wireless:RCN-E-E3				

### NOTES:

The data are measured under the following conditions(R32 : ISO-T1, -H1 / R410A : ISO-T1).  
 Cooling:Indoor temp. of 27°CDB, 19°CWB, and outdoor temp. of 35°CDB. Heating:Indoor temp. of 20°CDB, and outdoor temp. of 7°CDB, 6°CWB.  
 \*1 : Indicates the value in an anechoic chamber. During operation these values are somewhat higher due to ambient conditions.  
 \*2 : If a cooling operation is conducted when the outdoor air temperature is -5°C or lower, the outdoor unit should be installed at a place where it is not influenced by natural wind. If wind blows, the low pressure will drop and compressor frequency will increase, this will cause the capacity to drop and may cause the unit to break down.  
 \*3 : The values are for one indoor unit operation. (Multi system only)

R32		Standard Inverter			
Set model name		FDE71VNPVH	FDE90VNPVH	FDE100VNPVH	FDE125VNPVH
Indoor unit		FDE71VH	FDE100VH	FDE100VH	FDE125VH
Outdoor unit		FDC71VNP-W	FDC90VNP-W	FDC100VNP-W	FDC125VNP-W
Power source		1 Phase 220-240V, 50Hz / 220V, 60Hz			
Nominal cooling capacity (Min~Max)		kW 7.1 ( 1.5 ~ 7.3 )	9.0 ( 2.1 ~ 9.5 )	10.0 ( 2.1 ~ 10.2 )	12.1 ( 5.0 ~ 12.1 )
Nominal heating capacity (Min~Max)		kW 7.1 ( 1.1 ~ 7.3 )	9.0 ( 1.7 ~ 9.5 )	10.0 ( 1.7 ~ 10.4 )	12.1 ( 4.0 ~ 13.3 )
Power consumption		Cooling/Heating kW 2.41 / 1.96	2.38 / 1.99	3.00 / 2.36	3.88 / 3.30
EER/COP		Cooling/Heating 2.95 / 3.62	3.78 / 4.52	3.33 / 4.24	3.12 / 3.30
Inrush current		A 5	5	5	5
Max. current		15.8	19	19	18
Sound power level*1	Indoor	Cooling/Heating 60 / 60	64 / 64	64 / 64	64 / 64
	Outdoor	Cooling/Heating 67 / 67	67 / 66	68 / 67	73 / 72
Sound pressure level*1	Indoor	Cooling (P-Hi/Hi/Me/Lo) dB(A) 47 / 41 / 37 / 32	48 / 43 / 38 / 34	48 / 43 / 38 / 34	48 / 45 / 40 / 35
	Outdoor	Heating (P-Hi/Hi/Me/Lo) 47 / 41 / 37 / 32	48 / 43 / 38 / 34	48 / 43 / 38 / 34	48 / 45 / 40 / 35
Air flow	Indoor	Cooling (P-Hi/Hi/Me/Lo) m³/min 20 / 16 / 13 / 10	32 / 26 / 21 / 16.5	32 / 26 / 21 / 16.5	32 / 29 / 23 / 17
	Outdoor	Heating (P-Hi/Hi/Me/Lo) 20 / 16 / 13 / 10	32 / 26 / 21 / 16.5	32 / 26 / 21 / 16.5	32 / 29 / 23 / 17
Exterior dimensions	Indoor	HeightxWidthxDepth mm 210 x 1,320 x 690	250 x 1,620 x 690		
	Outdoor	640 x 800(+71) x 290	750 x 880(+88) x 340	845 x 970 x 370	
Net weight	Indoor	kg 33	43		
	Outdoor	45	57	73	
Ref.piping size	Liquid/Gas	ømm 6.35(1/4") / 12.7(1/2")	6.35(1/4") / 15.88(5/8")		9.52(3/8") / 15.88(5/8")
Refrigerant line (one way) length		m Max.30			
Vertical height differences		m Outdoor is higher/lower Max.20 / Max.20			
Outdoor operating temperature range	Cooling	°CDB -15~46*2			
	Heating	°CWB -15~20			
Air filter, Q'ty		Pocket Plastic net x2(Washable)			
Remote control (option)		wired:RC-EX3A, RC-E5, RCH-E3 wireless:RCN-E-E3			

R410A		Standard Inverter			
Set model name		FDE71VNPVH	FDE90VNP1VH	FDE100VNP1VH	
Indoor unit		FDE71VH	FDE100VH	FDE100VH	
Outdoor unit		FDC71VNP	FDC90VNP1	FDC100VNP	
Power source		1 Phase 220-240V, 50Hz / 220V, 60Hz			
Nominal cooling capacity (Min~Max)		kW 7.1 ( 1.4 ~ 7.1 )	9.0 ( 1.9 ~ 9.0 )	10.0 ( 2.8 ~ 11.2 )	
Nominal heating capacity (Min~Max)		kW 7.1 ( 1.0 ~ 7.1 )	9.0 ( 1.5 ~ 9.0 )	11.2 ( 2.5 ~ 12.5 )	
Power consumption		Cooling/Heating kW 2.50 / 1.96	2.75 / 2.22	2.66 / 2.94	
EER/COP		Cooling/Heating 2.84 / 3.62	3.27 / 4.05	3.76 / 3.81	
Inrush current		A 5	5	5	
Max. current		14.5	18	21	
Sound power level*1	Indoor	Cooling/Heating 60 / 60	64 / 64	64 / 64	
	Outdoor	Cooling/Heating 67 / 67	69 / 69	70 / 70	
Sound pressure level*1	Indoor	Cooling (P-Hi/Hi/Me/Lo) dB(A) 47 / 41 / 37 / 32	48 / 43 / 38 / 34	48 / 43 / 38 / 34	
	Outdoor	Heating (P-Hi/Hi/Me/Lo) 47 / 41 / 37 / 32	48 / 43 / 38 / 34	48 / 43 / 38 / 34	
Air flow	Indoor	Cooling (P-Hi/Hi/Me/Lo) m³/min 20 / 16 / 13 / 10	32 / 26 / 21 / 16.5	32 / 26 / 21 / 16.5	
	Outdoor	Heating (P-Hi/Hi/Me/Lo) 20 / 16 / 13 / 10	32 / 26 / 21 / 16.5	32 / 26 / 21 / 16.5	
Exterior dimensions	Indoor	HeightxWidthxDepth mm 210 x 1,320 x 690	250 x 1,620 x 690		
	Outdoor	640 x 800(+71) x 290	750 x 880(+88) x 340	845 x 970 x 370	
Net weight	Indoor	kg 33	43		
	Outdoor	45	57	70	
Ref.piping size	Liquid/Gas	ømm 6.35(1/4") / 12.7(1/2")	6.35(1/4") / 15.88(5/8")		9.52(3/8") / 15.88(5/8")
Refrigerant line (one way) length		m Max.30			
Vertical height differences		m Outdoor is higher/lower Max.20 / Max.20			
Outdoor operating temperature range	Cooling	°CDB -15~46*2			
	Heating	°CWB -15~20			
Air filter, Q'ty		Pocket Plastic net x2(Washable)			
Remote control (option)		wired:RC-EX3A, RC-E5, RCH-E3 wireless:RCN-E-E3			

# FDF

## Indoor Unit Floor Standing

New



FDF 71/100/125/140

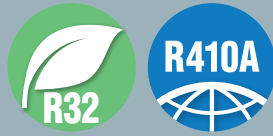
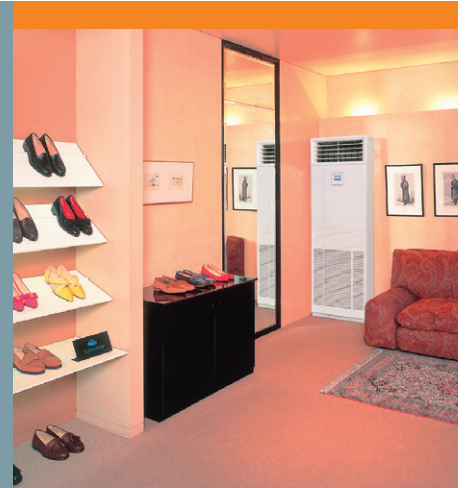

### Remote control

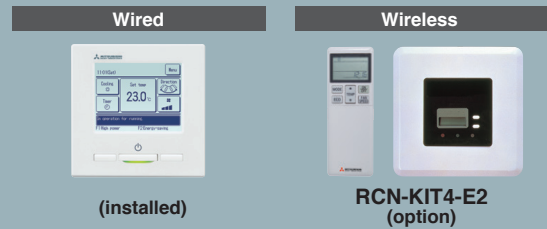

\*Not all functions available with all remote control options.

\*The remote control for the FDF-VD series will be RC-E5 type remote.

## High Efficiency

Energy efficiency is improved by New heat exchanger design (In case of Hyper INV).

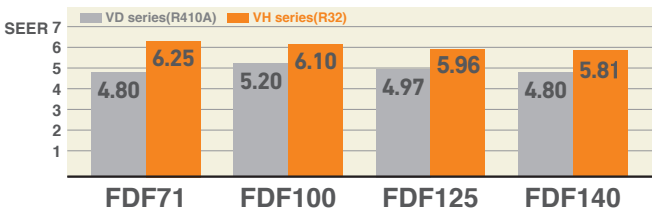

## Improved operability and visibility

Equipped with eco-touch remote control as standard equipment. Various functions can now be controlled. (VH series)



## Wide and Powerful Air Flow

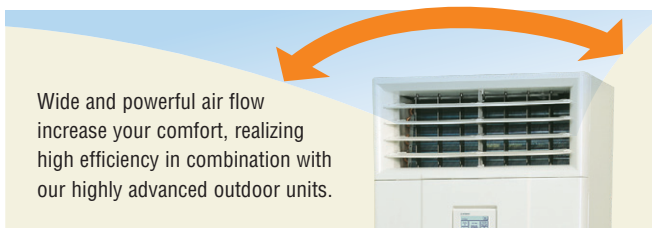

Wide and powerful air flow increase your comfort, realizing high efficiency in combination with our highly advanced outdoor units.

## Equipped with a leak detector device

Can now be safely used with the new refrigerant detector that detects leakage of the refrigerant. (VH series)

Remote control will integrate leak detector functions:  
Audible and visible alarm



## Motion Sensor (Option)

Motion sensor is equipped in the ceiling plane or wall plane and detects the presence/absence and activity of humans in a room to improve the comfort and energy saving performance of the unit.

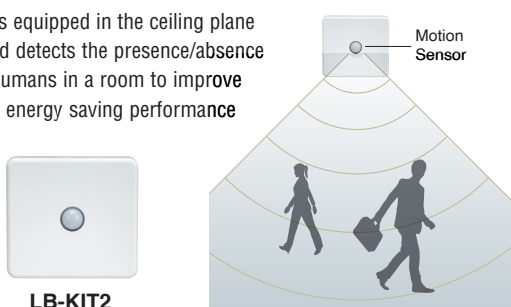

### Leak detector



inside



# Easy Transportation and Installation Workability

Piping and drain hose connection can be selected out of 4-directions and the selection makes installation workability more effective.

Due to slim design (Depth: 329mm, weight:49kg), easy transportation and installation are realized.

## Easy Maintenance

The surface of heat exchanger can be appeared only removing the front panel. Easy cleaning of heat exchanger is possible.

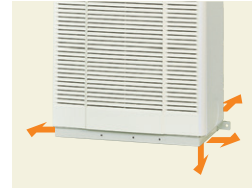

## OUTDOOR UNIT

		Hyper Inverter	
FDC		71VNX-W	100~140VN(S)X-W
		71VNX	100~140VN(S)X
model			
Chargeless		30m	
Height x Width x Depth (mm)		750 x 880(+88) x 340	1,300 x 970 x 370

		Micro Inverter			Standard Inverter		
FDC		100~140VN(S)A-W	-	200~250~280VSA-W	71VNP-W	90~100VNP-W	-
		100~140VN(S)A	200VSA	250VSA	71VNP	90VNP1	100VNP
model							
Chargeless		30m			15m		
Height x Width x Depth (mm)		845 x 970 x 370	1,300 x 970 x 370	1,505 x 970 x 370	640 x 800(+71) x 290	750 x 880(+88) x 340	845 x 970 x 370

## DIMENSIONS (Unit:mm) - FDF -

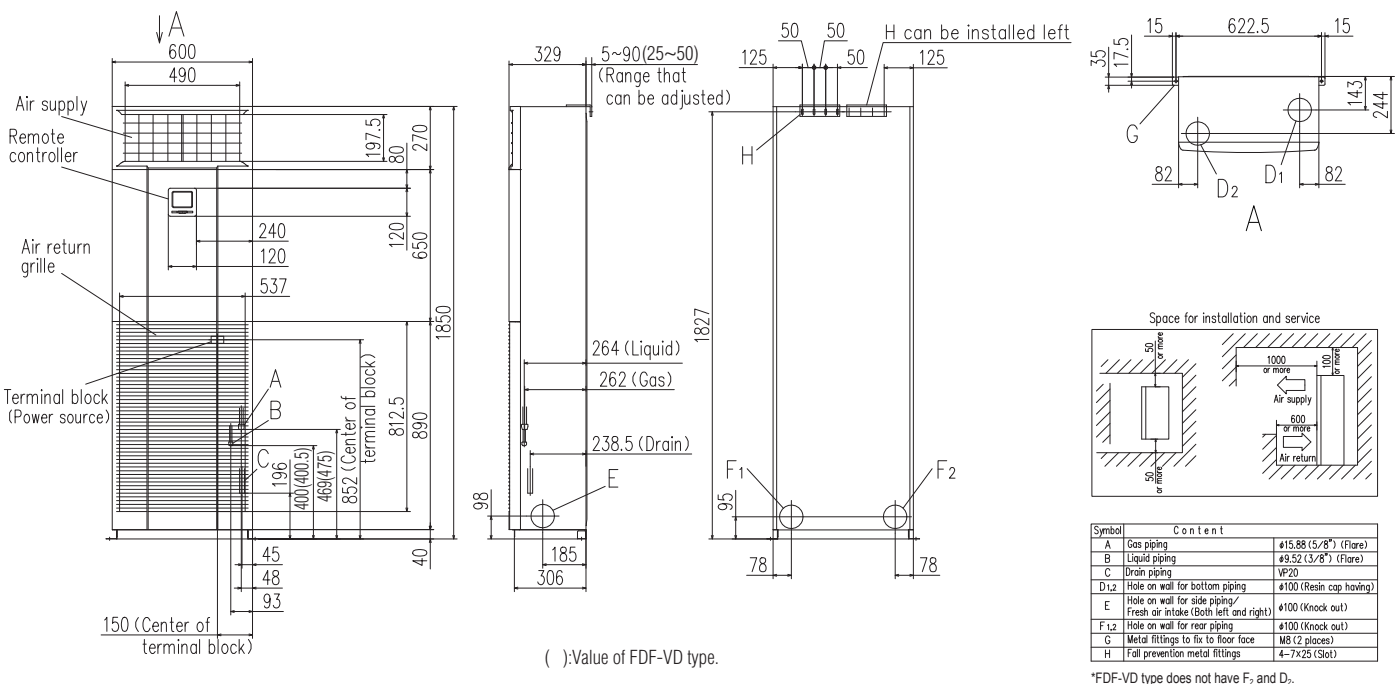

## SPECIFICATIONS - FDF -

R32		Hyper Inverter			
Set model name		FDF71VNXWVH	FDF100VNXWVH	FDF125VNXWVH	FDF140VNXWVH
Indoor unit		FDF71VH	FDF100VH	FDF125VH	FDF140VH
Outdoor unit		FDC71VNX-W	FDC100VNX-W	FDC125VNX-W	FDC140VNX-W
Power source		1 Phase 220-240V, 50Hz / 220V, 60Hz			
Nominal cooling capacity (Min-Max)		kW 7.1 (3.2 ~ 8.0)	10.0 (3.5 ~ 11.2)	12.5 (3.5 ~ 14.0)	14.0 (3.5 ~ 16.0)
Nominal heating capacity (Min-Max)		kW 8.0 (3.6 ~ 9.0)	11.2 (2.7 ~ 12.5)	14.0 (2.7 ~ 17.0)	16.0 (2.7 ~ 18.0)
Power consumption		Cooling/Heating kW 1.97 / 2.21	2.66 / 2.94	3.74 / 3.88	4.62 / 4.69
EER/COP		Cooling/Heating 3.61 / 3.62	3.76 / 3.81	3.34 / 3.61	3.03 / 3.41
Inrush current		A 5			
Max. current		A 19.1			
Sound power level*1	Indoor	Cooling/Heating 55 / 55	65 / 65	67 / 67	67 / 67
	Outdoor	Cooling/Heating 66 / 66	67 / 67	68 / 70	69 / 71
Sound pressure level*1	Indoor	Cooling (P-Hi/Hi/Me/Lo) dB(A) 42 / 39 / 35 / 33	53 / 51 / 49 / 44	55 / 51 / 49 / 44	55 / 51 / 49 / 44
	Outdoor	Heating (P-Hi/Hi/Me/Lo) 42 / 39 / 35 / 33	53 / 51 / 49 / 44	55 / 51 / 49 / 44	55 / 51 / 49 / 44
Air flow	Indoor	Cooling (P-Hi/Hi/Me/Lo) m³/min 18 / 16 / 14 / 12	27 / 26 / 23 / 19	29 / 26 / 23 / 19	29 / 26 / 23 / 19
		Heating (P-Hi/Hi/Me/Lo) 18 / 16 / 14 / 12	27 / 26 / 23 / 19	29 / 26 / 23 / 19	29 / 26 / 23 / 19
	Outdoor	Cooling/Heating 60 / 50	100 / 100	100 / 100	100 / 100
Exterior dimensions	Indoor	HeightxWidthxDepth mm 1,850 × 600 × 329			
	Outdoor	750 × 880(+88) × 340			
Net weight	Indoor	kg 49			
	Outdoor	60			
Ref.piping size	Liquid/Gas	ømm 9.52(3/8") / 15.88(5/8")			
Refrigerant line (one way) length		m Max.50	Min. 3, Max.100		
Vertical height differences		Outdoor is higher/lower m Max.30 / Max.15	Max.50 / Max.15		
Outdoor operating temperature range		Cooling °CDB -15~50*2			
		Heating °CWB -20~20			
Air filter, Q'ty		Plastic net x1(Washable)			
Remote control (option)		wired : RC-EX3A, RC-E5, RCH-E3 wireless : RCN-KIT4-E2			

R32		Hyper Inverter			
Set model name		FDF100VSXWVH	FDF125VSXWVH	FDF140VSXWVH	
Indoor unit		FDF100VH	FDF125VH	FDF140VH	
Outdoor unit		FDC100VSX-W	FDC125VSX-W	FDC140VSX-W	
Power source		3 Phase 380-415V, 50Hz / 380V, 60Hz			
Nominal cooling capacity (Min-Max)		kW 10.0 (3.5 ~ 11.2)	12.5 (3.5 ~ 14.0)	14.0 (3.5 ~ 16.0)	
Nominal heating capacity (Min-Max)		kW 11.2 (2.7 ~ 16.0)	14.0 (2.7 ~ 18.0)	16.0 (2.7 ~ 20.0)	
Power consumption		Cooling/Heating kW 2.66 / 2.95	3.74 / 3.88	4.62 / 4.70	
EER/COP		Cooling/Heating 3.76 / 3.80	3.34 / 3.61	3.03 / 3.41	
Inrush current		A 5			
Max. current		A 14.0			
Sound power level*1	Indoor	Cooling/Heating 65 / 65	67 / 67	67 / 67	
	Outdoor	Cooling/Heating 67 / 67	68 / 70	69 / 71	
Sound pressure level*1	Indoor	Cooling (P-Hi/Hi/Me/Lo) dB(A) 53 / 51 / 49 / 44	55 / 51 / 49 / 44	55 / 51 / 49 / 44	
	Outdoor	Heating (P-Hi/Hi/Me/Lo) 53 / 51 / 49 / 44	55 / 51 / 49 / 44	55 / 51 / 49 / 44	
Air flow	Indoor	Cooling (P-Hi/Hi/Me/Lo) m³/min 27 / 26 / 23 / 19	29 / 26 / 23 / 19	29 / 26 / 23 / 19	
		Heating (P-Hi/Hi/Me/Lo) 27 / 26 / 23 / 19	29 / 26 / 23 / 19	29 / 26 / 23 / 19	
	Outdoor	Cooling/Heating 100 / 100	100 / 100	100 / 100	
Exterior dimensions	Indoor	HeightxWidthxDepth mm 1,850 × 600 × 329			
	Outdoor	1300 × 970 × 370			
Net weight	Indoor	kg 49			
	Outdoor	99			
Ref.piping size	Liquid/Gas	ømm 9.52(3/8") / 15.88(5/8")			
Refrigerant line (one way) length		m Min. 3, Max.100			
Vertical height differences		m Max.50 / Max.15			
Outdoor operating temperature range		Cooling °CDB -15~50*2			
		Heating °CWB -20~20			
Air filter, Q'ty		Plastic net x 1(washable)			
Remote control (option)		wired : RC-EX3A, RC-E5, RCH-E3 wireless : RCN-KIT4-E2			

### NOTES:

The data are measured under the following conditions(R32 : ISO-T1, -H1 / R410A : ISO-T1).  
Cooling:Indoor temp. of 27°CDB, 19°CWB, and outdoor temp. of 35°CDB. Heating:Indoor temp. of 20°CDB, and outdoor temp. of 7°CDB, 6°CWB.  
\*1 : Indicates the value in an anechoic chamber. During operation these values are somewhat higher due to ambient conditions.  
\*2 : If a cooling operation is conducted when the outdoor air temperature is -5°C or lower, the outdoor unit should be installed at a place where it is not influenced by natural wind. If wind blows, the low pressure will drop and compressor frequency will increase, this will cause the capacity to drop and may cause the unit to break down.  
\*3 : The values are for one indoor unit operation. (Multi system only)

The values are for simultaneous Multi operation.

R32			Hyper Inverter	
Set model name			fdf140VNXWPVH	fdf140VSXWPVH
			Twin	
Indoor unit			fdf71VH x 2	
Outdoor unit			fDC140VNX-W	
Power source			1 Phase 220-240V, 50Hz / 220V, 60Hz	
Nominal cooling capacity (Min~Max)	kW		14.0 ( 3.5 ~ 16.0 )	
Nominal heating capacity (Min~Max)	kW		16.0 ( 2.7 ~ 18.0 )	
Power consumption	Cooling/Heating	kW	3.78 / 4.26	
EER/COP	Cooling/Heating		3.71 / 3.75	
Inrush current		A	5	
Max. current			27.0	
Sound power level*1	Indoor	Cooling/Heating	55 / 55	
	Outdoor	Cooling/Heating	69 / 71	
Sound pressure level*1	Indoor	Cooling (P-Hi/Hi/Me/Lo)	42 / 39 / 35 / 33	
	Indoor	Heating (P-Hi/Hi/Me/Lo)	42 / 39 / 35 / 33	
Air flow	Outdoor	Cooling/Heating	54 / 54	
	Indoor	Cooling (P-Hi/Hi/Me/Lo)	18 / 16 / 14 / 12	
	Indoor	Heating (P-Hi/Hi/Me/Lo)	18 / 16 / 14 / 12	
	Outdoor	Cooling/Heating	100 / 100	
Exterior dimensions	Indoor	HeightxWidthxDepth	1,850 × 600 × 329	
	Outdoor		1300 × 970 × 370	
Net weight	Indoor		47	
	Outdoor		97	
Ref.piping size	Liquid/Gas	ømm	9.52(3/8") / 15.88(5/8")	
Refrigerant line (one way) length		m	Min. 3, Max.100	
Vertical height differences	Outdoor is higher/lower	m	Max.50 / Max.15	
Outdoor operating temperature range	Cooling	°CDB	-15~50*2	
	Heating	°CWB	-20~20	
Air filter, Q'ty			Plastic net x1(Washable)	
Remote control (option)			wired : RC-EX3A, RC-E5, RCH-E3 wireless : RCN-KIT4-E2	

R410A			Hyper Inverter			
Set model name			fdf71VNXVD1	fdf100VNXVD2	fdf125VNXVD	fdf140VNXVD
Indoor unit			fdf71VD1	fdf100VD2	fdf125VD	fdf140VD
Outdoor unit			fDC71VNX	fDC100VNX	fDC125VNX	fDC140VNX
Power source			1 Phase 220-240V, 50Hz / 220V, 60Hz			
Nominal cooling capacity (Min~Max)	kW		7.1 ( 3.2 ~ 8.0 )	10.0 ( 4.0 ~ 11.2 )	12.5 ( 5.0 ~ 14.0 )	14.0 ( 5.0 ~ 16.0 )
Nominal heating capacity (Min~Max)	kW		8.0 ( 3.6 ~ 9.0 )	11.2 ( 4.0 ~ 12.5 )	14.0 ( 4.0 ~ 17.0 )	16.0 ( 4.0 ~ 18.0 )
Power consumption	Cooling/Heating	kW	2.21 / 2.21	2.83 / 3.04	3.89 / 3.88	4.65 / 4.69
EER/COP	Cooling/Heating		3.21 / 3.62	3.53 / 3.68	3.21 / 3.61	3.01 / 3.41
Inrush current		A	5	5	5	5
Max. current			17	24	26	26
Sound power level*1	Indoor	Cooling/Heating	61 / 61	65 / 65	73 / 73	73 / 73
	Outdoor	Cooling/Heating	66 / 66	70 / 70	70 / 70	72 / 72
Sound pressure level*1	Indoor	Cooling (P-Hi/Hi/Me/Lo)	42 / 39 / 35 / 33	54 / 50 / 48 / 44	54 / 50 / 48 / 44	54 / 50 / 48 / 44
	Indoor	Heating (P-Hi/Hi/Me/Lo)	42 / 39 / 35 / 33	54 / 50 / 48 / 44	54 / 50 / 48 / 44	54 / 50 / 48 / 44
Air flow	Outdoor	Cooling/Heating	51 / 48	48 / 50	48 / 50	49 / 52
	Indoor	Cooling (P-Hi/Hi/Me/Lo)	20 / 18 / 16 / 14	29 / 26 / 23 / 19	29 / 26 / 23 / 19	29 / 26 / 23 / 19
	Indoor	Heating (P-Hi/Hi/Me/Lo)	20 / 18 / 16 / 14	29 / 26 / 23 / 19	29 / 26 / 23 / 19	29 / 26 / 23 / 19
	Outdoor	Cooling/Heating	60 / 50	100 / 100	100 / 100	100 / 100
Exterior dimensions	Indoor	HeightxWidthxDepth	1,850 × 600 × 329			
	Outdoor		750 x 880(+88) x 340	1,300 x 970 x 370		
Net weight	Indoor		49	52		
	Outdoor		60	105		
Ref.piping size	Liquid/Gas	ømm	9.52(3/8") / 15.88(5/8")			
Refrigerant line (one way) length		m	Max.50	Max.100		
Vertical height differences	Outdoor is higher/lower	m	Max.30 / Max.15			
Outdoor operating temperature range	Cooling	°CDB	-15~43*2			
	Heating	°CWB	-20~20			
Air filter, Q'ty			Plastic net x 1(washable)			
Remote control			wired:RC-E5 (installed) wireless:RCN-KIT4-E2 (option)			

## SPECIFICATIONS - FDF -

R410A			Hyper Inverter		
Set model name			FDF100VSXVD2	FDF125VSXVD	FDF140VSXVD
Indoor unit			FDF100VD2	FDF125VD	FDF140VD
Outdoor unit			FDC100VSX	FDC125VSX	FDC140VSX
Power source			3 Phase 380-415V, 50Hz / 380V, 60Hz		
Nominal cooling capacity (Min~Max)			10.0 (4.0 ~ 11.2)	12.5 (5.0 ~ 14.0)	14.0 (5.0 ~ 16.0)
Nominal heating capacity (Min~Max)			11.2 (4.0 ~ 16.0)	14.0 (4.0 ~ 18.0)	16.0 (4.0 ~ 20.0)
Power consumption			2.83 / 3.04	3.89 / 3.88	4.65 / 4.69
EER/COP			3.53 / 3.68	3.21 / 3.61	3.01 / 3.41
Inrush current			5	5	5
Max. current			15	15	15
Sound power level*1	Indoor	Cooling/Heating	65 / 65	73 / 73	73 / 73
	Outdoor	Cooling/Heating	70 / 70	70 / 70	72 / 72
Sound pressure level*1	Indoor	Cooling (P-Hi/Hi/Me/Lo)	54 / 50 / 48 / 44	54 / 50 / 48 / 44	54 / 50 / 48 / 44
		Heating (P-Hi/Hi/Me/Lo)	54 / 50 / 48 / 44	54 / 50 / 48 / 44	54 / 50 / 48 / 44
	Outdoor	Cooling/Heating	48 / 50	48 / 50	49 / 52
		Cooling (P-Hi/Hi/Me/Lo)	29 / 26 / 23 / 19	29 / 26 / 23 / 19	29 / 26 / 23 / 19
Air flow	Indoor	Heating (P-Hi/Hi/Me/Lo)	29 / 26 / 23 / 19	29 / 26 / 23 / 19	29 / 26 / 23 / 19
		Cooling/Heating	100 / 100	100 / 100	100 / 100
	Outdoor	Cooling/Heating	100 / 100	100 / 100	100 / 100
Exterior dimensions	Indoor	HeightxWidthxDepth	1,850 x 600 x 329		
	Outdoor	HeightxWidthxDepth	1,300 x 970 x 370		
Net weight	Indoor		52		
	Outdoor		105		
Ref.piping size	Liquid/Gas	ømm	9.52(3/8") / 15.88(5/8")		
Refrigerant line (one way) length			Max.100		
Vertical height differences			Outdoor is higher/lower		
Outdoor operating temperature range			Max.30 / Max.15		
Outdoor operating temperature range			Cooling °CDB -15~43*2		
Outdoor operating temperature range			Heating °CWB -20~20		
Air filter, Q'ty			Plastic net x 1(washable)		
Remote control			wired:RC-E5 (installed) wireless:RCN-KIT4-E2 (option)		

The values are for simultaneous Multi operation.

R410A			Hyper Inverter		
Set model name			FDF140VNXPD1	Twin	FDF140VSXPVD1
Indoor unit			FDF71VD1 x 2		FDF71VD1 x 2
Outdoor unit			FDC140VNX		FDC140VSX
Power source			1 Phase 220-240V, 50Hz / 220V, 60Hz		3 Phase 380-415V, 50Hz / 380V 60Hz
Nominal cooling capacity (Min~Max)			14.0 (5.0 ~ 16.0)		14.0 (5.0 ~ 16.0)
Nominal heating capacity (Min~Max)			16.0 (4.0 ~ 18.0)		16.0 (4.0 ~ 20.0)
Power consumption			4.83 / 4.97		4.83 / 4.97
EER/COP			2.90 / 3.22		2.90 / 3.22
Inrush current			5		5
Max. current			26		15
Sound power level*1	Indoor*3	Cooling/Heating	61 / 61		61 / 61
	Outdoor	Cooling/Heating	72 / 72		72 / 72
Sound pressure level*1	Indoor*3	Cooling (P-Hi/Hi/Me/Lo)	42 / 39 / 35 / 33		42 / 39 / 35 / 33
		Heating (P-Hi/Hi/Me/Lo)	42 / 39 / 35 / 33		42 / 39 / 35 / 33
	Outdoor	Cooling/Heating	49 / 52		49 / 52
		Cooling (P-Hi/Hi/Me/Lo)	18 / 16 / 14 / 12		18 / 16 / 14 / 12
Air flow	Indoor*3	Heating (P-Hi/Hi/Me/Lo)	18 / 16 / 14 / 12		18 / 16 / 14 / 12
		Cooling/Heating	100 / 100		100 / 100
	Outdoor	Cooling/Heating	100 / 100		100 / 100
Exterior dimensions	Indoor	HeightxWidthxDepth	1,850 x 600 x 329		
	Outdoor	HeightxWidthxDepth	1,300 x 970 x 370		
Net weight	Indoor		49		
	Outdoor		105		
Ref.piping size	Liquid/Gas	ømm	9.52(3/8") / 15.88(5/8")		
Refrigerant line (one way) length			Max.100		
Vertical height differences			Outdoor is higher/lower		
Outdoor operating temperature range			Max.30 / Max.15		
Outdoor operating temperature range			Cooling °CDB -15~43*2		
Outdoor operating temperature range			Heating °CWB -20~20		
Air filter, Q'ty			Plastic net x 1(washable)		
Remote control			wired:RC-E5 (installed) wireless:RCN-KIT4-E2 (option)		

### NOTES:

The data are measured under the following conditions(R32 : ISO-T1, -H1 / R410A : ISO-T1).  
Cooling:Indoor temp. of 27°CDB, 19°CWB, and outdoor temp. of 35°CDB. Heating:Indoor temp. of 20°CDB, and outdoor temp. of 7°CDB, 6°CWB.  
\*1 : Indicates the value in an anechoic chamber. During operation these values are somewhat higher due to ambient conditions.  
\*2 : If a cooling operation is conducted when the outdoor air temperature is -5°C or lower, the outdoor unit should be installed at a place where it is not influenced by natural wind. If wind blows, the low pressure will drop and compressor frequency will increase, this will cause the capacity to drop and may cause the unit to break down.  
\*3 : The values are for one indoor unit operation. (Multi system only)

R32		Micro Inverter		
Set model name		FDF100VNAWVH	FDF125VNAWVH	FDF140VNAWVH
Indoor unit		FDF100VH	FDF125VH	FDF140VH
Outdoor unit		FDC100VNA-W	FDC125VNA-W	FDC140VNA-W
Power source		1 Phase 220-240V, 50Hz / 220V, 60Hz		
Nominal cooling capacity (Min-Max)		kW 10.0 ( 4.0 ~ 11.2 )	12.5 ( 5.0 ~ 14.0 )	13.6 ( 5.0 ~ 14.5 )
Nominal heating capacity (Min-Max)		kW 11.2 ( 4.0 ~ 12.5 )	14.0 ( 4.0 ~ 16.0 )	15.5 ( 4.0 ~ 16.5 )
Power consumption		Cooling/Heating kW 3.08 / 2.94	4.65 / 4.10	5.35 / 4.98
EER/COP		Cooling/Heating 3.25 / 3.81	2.69 / 3.42	2.54 / 3.11
Inrush current		A 5	5	5
Max. current		24.0	24.0	24.0
Sound power level*1	Indoor	Cooling/Heating 65 / 65	67 / 67	67 / 67
	Outdoor	Cooling/Heating 69 / 70	71 / 71	72 / 73
Sound pressure level*1	Indoor	Cooling (P-Hi/Hi/Me/Lo) dB(A) 53 / 51 / 49 / 44	55 / 51 / 49 / 44	55 / 51 / 49 / 44
		Heating (P-Hi/Hi/Me/Lo) 53 / 51 / 49 / 44	55 / 51 / 49 / 44	55 / 51 / 49 / 44
	Outdoor	Cooling/Heating 54 / 55	54 / 56	56 / 58
		Air flow	Indoor Cooling (P-Hi/Hi/Me/Lo) m³/min 27 / 26 / 23 / 19	29 / 26 / 23 / 19
	Indoor Heating (P-Hi/Hi/Me/Lo) 27 / 26 / 23 / 19	29 / 26 / 23 / 19	29 / 26 / 23 / 19	
	Outdoor Cooling/Heating 75 / 73	75 / 73	75 / 73	
Exterior dimensions	Indoor	HeightxWidthxDepth mm	1,850 × 600 × 329	
	Outdoor	845 × 970 × 370		
Net weight	Indoor	kg	49	
	Outdoor	77		
Ref.piping size	Liquid/Gas	ømm	9.52(3/8") / 15.88(5/8")	
Refrigerant line (one way) length		m	Max.50	
Vertical height differences		Outdoor is higher/lower m	Max.50 / Max.15	
Outdoor operating temperature range	Cooling	°CDB	-15~50*2	
	Heating	°CWB	-20~20	
Air filter, Q'ty		Plastic net x1(Washable)		
Remote control (option)		wired : RC-EX3A, RC-E5, RCH-E3 wireless : RCN-KIT4-E2		

R32		Micro Inverter		
Set model name		FDF100VSAWVH	FDF125VSAWVH	FDF140VSAWVH
Indoor unit		FDF100VH	FDF125VH	FDF140VH
Outdoor unit		FDC100VSA-W	FDC125VSA-W	FDC140VSA-W
Power source		3 Phase 380-415V, 50Hz / 380V, 60Hz		
Nominal cooling capacity (Min-Max)		kW 10.0 ( 4.0 ~ 11.2 )	12.5 ( 5.0 ~ 14.0 )	13.6 ( 5.0 ~ 14.5 )
Nominal heating capacity (Min-Max)		kW 11.2 ( 4.0 ~ 12.5 )	14.0 ( 4.0 ~ 16.0 )	15.5 ( 4.0 ~ 16.5 )
Power consumption		Cooling/Heating kW 3.09 / 2.94	4.65 / 4.09	5.42 / 4.98
EER/COP		Cooling/Heating 3.25 / 3.81	2.69 / 3.42	2.51 / 3.11
Inrush current		A 5	5	5
Max. current		15.0	15.0	15.0
Sound power level*1	Indoor	Cooling/Heating 65 / 65	67 / 67	67 / 67
	Outdoor	Cooling/Heating 69 / 70	71 / 71	72 / 73
Sound pressure level*1	Indoor	Cooling (P-Hi/Hi/Me/Lo) dB(A) 53 / 51 / 49 / 44	55 / 51 / 49 / 44	55 / 51 / 49 / 44
		Heating (P-Hi/Hi/Me/Lo) 53 / 51 / 49 / 44	55 / 51 / 49 / 44	55 / 51 / 49 / 44
	Outdoor	Cooling/Heating 54 / 55	54 / 56	56 / 58
		Air flow	Indoor Cooling (P-Hi/Hi/Me/Lo) m³/min 27 / 26 / 23 / 19	29 / 26 / 23 / 19
	Indoor Heating (P-Hi/Hi/Me/Lo) 27 / 26 / 23 / 19	29 / 26 / 23 / 19	29 / 26 / 23 / 19	
	Outdoor Cooling/Heating 75 / 73	75 / 73	75 / 73	
Exterior dimensions	Indoor	HeightxWidthxDepth mm	1,850 × 600 × 329	
	Outdoor	845 × 970 × 370		
Net weight	Indoor	kg	49	
	Outdoor	78		
Ref.piping size	Liquid/Gas	ømm	9.52(3/8") / 15.88(5/8")	
Refrigerant line (one way) length		m	Max.50	
Vertical height differences		Outdoor is higher/lower m	Max.50 / Max.15	
Outdoor operating temperature range	Cooling	°CDB	-15~50*2	
	Heating	°CWB	-20~20	
Air filter, Q'ty		Plastic net x1(Washable)		
Remote control (option)		wired : RC-EX3A, RC-E5, RCH-E3 wireless : RCN-KIT4-E2		

# SPECIFICATIONS - FDF -

The values are for simultaneous Multi operation.

R32			Micro Inverter				
Set model name			FDF140VNAWPVH	FDF140VSAWPVH	FDF200VSAWPVH	FDF250VSAWPVH	FDF280VSAWPVH
Indoor unit			FDF71VH x 2	FDF71VH x 2	FDF100VH x 2	FDF125VH x 2	FDF140VH x 2
Outdoor unit			FDC140VNA-W	FDC140VSA-W	FDC200VSA-W	FDC250VSA-W	FDC280VSA-W
Power source			1 Phase 220-240V, 50Hz / 220V, 60Hz		3 Phase 380-415V, 50Hz / 380V, 60Hz		
Nominal cooling capacity (Min~Max)			kW 13.6 ( 5.0 ~ 14.5 )	13.6 ( 5.0 ~ 14.5 )	20.0 ( 6.8 ~ 22.4 )	25.0 ( 6.8 ~ 28.0 )	27.0 ( 7.5 ~ 31.5 )
Nominal heating capacity (Min~Max)			kW 15.5 ( 4.0 ~ 16.5 )	15.5 ( 4.0 ~ 16.5 )	22.4 ( 6.6 ~ 25.0 )	28.0 ( 5.7 ~ 31.5 )	30.0 ( 6.3 ~ 33.5 )
Power consumption			kW 4.46 / 4.49	4.58 / 4.49	6.71 / 6.06	9.54 / 8.37	10.93 / 9.47
EER/COP			Cooling/Heating 3.05 / 3.46	3.05 / 3.46	2.98 / 3.69	2.62 / 3.35	2.47 / 3.17
Inrush current			A 5	5	5	5	5
Max. current			24.0	15.0	19.0	20.0	20.0
Sound power level*1	Indoor	Cooling/Heating	55 / 55	55 / 55	65 / 65	67 / 67	67 / 67
	Outdoor	Cooling/Heating	72 / 73	72 / 73	72 / 74	73 / 75	75 / 77
Sound pressure level*1	Indoor	Cooling (P-Hi/Hi/Me/Lo)	42 / 39 / 35 / 33	42 / 39 / 35 / 33	53 / 51 / 49 / 44	55 / 51 / 49 / 44	55 / 51 / 49 / 44
	Outdoor	Heating (P-Hi/Hi/Me/Lo)	42 / 39 / 35 / 33	42 / 39 / 35 / 33	53 / 51 / 49 / 44	55 / 51 / 49 / 44	55 / 51 / 49 / 44
Air flow	Indoor	Cooling/Heating	m³/min 56 / 58	56 / 58	58 / 59	58 / 62	61 / 63
	Outdoor	Cooling/Heating	18 / 16 / 14 / 12	18 / 16 / 14 / 12	27 / 26 / 23 / 19	29 / 26 / 23 / 19	29 / 26 / 23 / 19
Exterior dimensions	Indoor	HeightxWidthxDepth	mm 18 / 16 / 14 / 12	18 / 16 / 14 / 12	27 / 26 / 23 / 19	29 / 26 / 23 / 19	29 / 26 / 23 / 19
	Outdoor	HeightxWidthxDepth	75 / 73	75 / 73	148 / 134	148 / 153	136 / 140
Net weight	Indoor	kg 845 x 970 x 370	47	49	145	155	
	Outdoor	kg 77	78	144			
Ref.piping size	Liquid/Gas	ømm 9.52(3/8") / 15.88(5/8")		9.52(3/8") / 22.22(7/8")		12.7(1/2") / 22.22(7/8")	
Refrigerant line (one way) length	m	Max.50		Max.70		Max.60	
Vertical height differences	Outdoor is higher/lower	m Max.50 / Max.15		Max.50*4 / Max.15			
Outdoor operating temperature range	Cooling	°CDB -15~50*2					
	Heating	°CWB -20~20					
Air filter, Q'ty				Plastic net x1(Washable)			
Remote control (option)				wired : RC-EX3A, RC-E5, RCH-E3		wireless : RCN-KIT4-E2	

R410A			Micro Inverter		
Set model name			FDF100VNAVD2	FDF125VNAVD	FDF140VNAVD
Indoor unit			FDF100VD2	FDF125VD	FDF140VD
Outdoor unit			FDC100VNA	FDC125VNA	FDC140VNA
Power source			1 Phase 220-240V, 50Hz / 220V, 60Hz		
Nominal cooling capacity (Min~Max)			kW 10.0 ( 4.0 ~ 11.2 )	12.5 ( 5.0 ~ 13.0 )	13.0 ( 5.0 ~ 13.0 )
Nominal heating capacity (Min~Max)			kW 11.2 ( 4.0 ~ 12.5 )	14.0 ( 4.0 ~ 16.0 )	15.5 ( 4.0 ~ 16.5 )
Power consumption			kW 3.12 / 2.94	4.65 / 4.14	5.02 / 4.98
EER/COP			Cooling/Heating 3.21 / 3.81	2.69 / 3.38	2.59 / 3.11
Inrush current			A 5	5	5
Max. current			24	24	24
Sound power level*1	Indoor	Cooling/Heating	65 / 65	73 / 73	73 / 73
	Outdoor	Cooling/Heating	70 / 70	71 / 71	73 / 73
Sound pressure level*1	Indoor	Cooling (P-Hi/Hi/Me/Lo)	54 / 50 / 48 / 44	54 / 50 / 48 / 44	54 / 50 / 48 / 44
	Outdoor	Heating (P-Hi/Hi/Me/Lo)	54 / 50 / 48 / 44	54 / 50 / 48 / 44	54 / 50 / 48 / 44
Air flow	Indoor	Cooling/Heating	m³/min 54 / 56	55 / 57	57 / 59
	Outdoor	Cooling/Heating	29 / 26 / 23 / 19	29 / 26 / 23 / 19	29 / 26 / 23 / 19
Exterior dimensions	Indoor	HeightxWidthxDepth	mm 1,850 x 600 x 329	845 x 970 x 370	
	Outdoor	HeightxWidthxDepth	52	80	
Ref.piping size	Liquid/Gas	ømm 9.52(3/8") / 15.88(5/8")			
Refrigerant line (one way) length	m	Max.50			
Vertical height differences	Outdoor is higher/lower	m Max.50 / Max.15			
Outdoor operating temperature range	Cooling	°CDB -15~50*2			
	Heating	°CWB -20~20			
Air filter, Q'ty				Plastic net x1(Washable)	
Remote control				wired:RC-E5 (installed)	wireless:RCN-KIT4-E2 (option)

NOTES:

The data are measured under the following conditions(R32 : ISO-T1, -H1 / R410A : ISO-T1).  
 Cooling:Indoor temp. of 27°CDB, 19°CWB, and outdoor temp. of 35°CDB. Heating:Indoor temp. of 20°CDB, and outdoor temp. of 7°CDB, 6°CWB.  
 \*1 : Indicates the value in an anechoic chamber. During operation these values are somewhat higher due to ambient conditions.  
 \*2 : If a cooling operation is conducted when the outdoor air temperature is -5°C or lower, the outdoor unit should be installed at a place where it is not influenced by natural wind. If wind blows, the low pressure will drop and compressor frequency will increase, this will cause the capacity to drop and may cause the unit to break down.  
 \*3 : The values are for one indoor unit operation. (Multi system only)  
 \*4 : In case of following conditions:Max.50m(Outdoor unit is higher & Outdoor temperature ≤ 43°C), Max.30m(Outdoor unit is higher & Outdoor temperature > 43°C)

R410A		Micro Inverter		
Set model name		FDF100VSAVD2	FDF125VSAVD	FDF140VSAVD
Indoor unit		FDF100VD2	FDF125VD	FDF140VD
Outdoor unit		FDC100VSA	FDC125VSA	FDC140VSA
Power source		3 Phase 380-415V, 50Hz / 380V, 60Hz		
Nominal cooling capacity (Min~Max)	kW	10.0 (4.0 ~ 11.2)	12.5 (5.0 ~ 14.0)	13.6 (5.0 ~ 14.5)
Nominal heating capacity (Min~Max)	kW	11.2 (4.0 ~ 12.5)	14.0 (4.0 ~ 16.0)	15.5 (4.0 ~ 16.5)
Power consumption	Cooling/Heating	3.12 / 2.94	4.65/ 4.14	5.42 / 4.98
EER/COP	Cooling/Heating	3.21 / 3.81	2.69 / 3.38	2.51 / 3.11
Inrush current		5	5	5
Max. current		15	15	15
Sound power level*1	Indoor	Cooling/Heating	65 / 65	73 / 73
	Outdoor	Cooling/Heating	70 / 70	73 / 73
Sound pressure level*1	Indoor	Cooling (P-Hi/Hi/Me/Lo)	54 / 50 / 48 / 44	54 / 50 / 48 / 44
		Heating (P-Hi/Hi/Me/Lo)	54 / 50 / 48 / 44	54 / 50 / 48 / 44
	Outdoor	Cooling/Heating	54 / 56	55 / 57
Air flow	Indoor	Cooling (P-Hi/Hi/Me/Lo)	29 / 26 / 23 / 19	29 / 26 / 23 / 19
		Heating (P-Hi/Hi/Me/Lo)	29 / 26 / 23 / 19	29 / 26 / 23 / 19
	Outdoor	Cooling/Heating	75 / 73	75 / 73
Exterior dimensions	Indoor	HeightxWidthxDepth	1,850 x 600 x 329	
	Outdoor		845 x 970 x 370	
Net weight	Indoor		52	
	Outdoor		82	
Ref.piping size	Liquid/Gas	ømm	9.52(3/8") / 15.88(5/8")	
Refrigerant line (one way) length		m	Max.50	
Vertical height differences	Outdoor is higher/lower	m	Max.50 / Max.15	
Outdoor operating temperature range	Cooling	°CDB	-15~50*2	
	Heating	°CWB	-20~20	
Air filter, Q'ty			Plastic net x 1(Washable)	
Remote control			wired:RC-E5 (installed) wireless:RCN-KIT4-E2 (option)	

The values are for simultaneous Multi operation.

R410A		Micro Inverter			
Set model name		FDF140VNAPVD1	FDF140VSAPVD1	FDF200VSAPVD2	FDF250VSAPVD
Indoor unit		FDF71VD1 x 2	FDF71VD1 x 2	FDF100VD2 x 2	FDF125VD x 2
Outdoor unit		FDC140VNA	FDC140VSA	FDC200VSA	FDC250VSA
Power source		1 Phase 220-240V, 50Hz / 220V, 60Hz		3 Phase 380-415V, 50Hz / 380V, 60Hz	
Nominal cooling capacity (Min~Max)	kW	13.6 (5.0 ~ 14.5)	13.6 (5.0 ~ 14.5)	19.0 (5.2 ~ 22.4)	24.0 (6.9 ~ 28.0)
Nominal heating capacity (Min~Max)	kW	15.5 (4.0 ~ 16.5)	15.5 (4.0 ~ 16.5)	22.4 (3.3 ~ 25.0)	27.0 (5.5 ~ 31.5)
Power consumption	Cooling/Heating	5.15 / 4.35	5.15 / 4.35	6.74 / 6.42	9.15 / 8.49
EER/COP	Cooling/Heating	2.64 / 3.56	2.64 / 3.56	2.82 / 3.49	2.62 / 3.18
Inrush current		5	5	5	5
Max. current		24	15	20	21
Sound power level*1	Indoor*3	Cooling/Heating	61 / 61	65 / 65	73 / 73
	Outdoor	Cooling/Heating	73 / 73	72 / 74	73 / 75
Sound pressure level*1	Indoor*3	Cooling (P-Hi/Hi/Me/Lo)	42 / 39 / 35 / 33	42 / 39 / 35 / 33	54 / 50 / 48 / 44
		Heating (P-Hi/Hi/Me/Lo)	42 / 39 / 35 / 33	42 / 39 / 35 / 33	54 / 50 / 48 / 44
	Outdoor	Cooling/Heating	57 / 59	58 / 59	59 / 62
Air flow	Indoor*3	Cooling (P-Hi/Hi/Me/Lo)	18 / 16 / 14 / 12	18 / 16 / 14 / 12	29 / 26 / 23 / 19
		Heating (P-Hi/Hi/Me/Lo)	18 / 16 / 14 / 12	18 / 16 / 14 / 12	29 / 26 / 23 / 19
	Outdoor	Cooling/Heating	75 / 73	135 / 135	143 / 151
Exterior dimensions	Indoor	HeightxWidthxDepth	1,850 x 600 x 329		
	Outdoor		845 x 970 x 370	1,300 x 970 x 370	1,505 x 970 x 370
Net weight	Indoor		49		
	Outdoor		80	82	115
Ref.piping size	Liquid/Gas	ømm	9.52(3/8") / 15.88(5/8")		12.7(1/2") / 22.22(7/8")
Refrigerant line (one way) length		m	Max.50		Max.70
Vertical height differences	Outdoor is higher/lower	m	Max.50 / Max.15		Max.30 / Max.15
Outdoor operating temperature range	Cooling	°CDB	-15~50*2		
	Heating	°CWB	-20~20		-15~20
Air filter, Q'ty			Plastic net x 1(washable)		
Remote control			wired:RC-E5 (installed) wireless:RCN-KIT4-E2 (option)		

## SPECIFICATIONS - FDF -

R32			Standard Inverter		
Set model name			FDF71VNPVH	FDF90VNPVH	FDF100VNPVH
Indoor unit			FDF71VH	FDF100VH	FDF100VH
Outdoor unit			FDC71VNP-W	FDC90VNP-W	FDC100VNP-W
Power source			1 Phase 220-240V, 50Hz / 220V, 60Hz		
Nominal cooling capacity (Min-Max)			kW 7.1 ( 1.5 ~ 7.3 )	9.0 ( 2.1 ~ 9.5 )	10.0 ( 2.1 ~ 10.2 )
Nominal heating capacity (Min-Max)			kW 7.1 ( 1.1 ~ 7.3 )	9.0 ( 1.7 ~ 9.5 )	10.0 ( 1.7 ~ 10.4 )
Power consumption			Cooling/Heating kW 2.51 / 2.02	2.50 / 2.24	3.39 / 2.71
EER/COP			Cooling/Heating 2.82 / 3.51	3.60 / 4.02	2.95 / 3.69
Inrush current			A 5	5	5
Max. current			15.8	19.0	19.0
Sound power level*1	Indoor	Cooling/Heating	55 / 55	65 / 65	65 / 65
	Outdoor	Cooling/Heating	67 / 67	67 / 66	68 / 67
Sound pressure level*1	Indoor	Cooling (P-Hi/Hi/Me/Lo)	dB(A) 42 / 39 / 35 / 33	53 / 51 / 49 / 44	53 / 51 / 49 / 44
		Heating (P-Hi/Hi/Me/Lo)		53 / 51 / 49 / 44	53 / 51 / 49 / 44
	Outdoor	Cooling/Heating	54 / 54	55 / 53	56 / 54
		Cooling (P-Hi/Hi/Me/Lo)	18 / 16 / 14 / 12	27 / 26 / 23 / 19	27 / 26 / 23 / 19
Air flow	Indoor	Heating (P-Hi/Hi/Me/Lo)	18 / 16 / 14 / 12	27 / 26 / 23 / 19	27 / 26 / 23 / 19
		Cooling/Heating	42 / 42	59 / 55	63 / 55
	Outdoor	Cooling/Heating	42 / 42	59 / 55	63 / 55
Exterior dimensions	Indoor	HeightxWidthxDepth	mm	1,850 x 600 x 329	
	Outdoor			640x800(+71)x290	750x880(+88)x340
Net weight	Indoor		kg	47	49
	Outdoor			45	57
Ref.piping size	Liquid/Gas	ømm	6.35(1/4") / 12.7(1/2")		
Refrigerant line (one way) length			m	26	25
Vertical height differences			Outdoor is higher/lower	m Max.20 / Max.20	
Outdoor operating temperature range	Cooling	°CDB	-15~46*2		
	Heating	°CWB	-15~20		
Air filter, Q'ty			Plastic net x1(Washable)		
Remote control (option)			wired : RC-EX3A, RC-E5, RCH-E3 wireless : RCN-KIT4-E2		

R410A			Standard Inverter		
Set model name			FDF71VNPVD1	FDF90VNP1VD2	FDF100VNP1VD2
Indoor unit			FDF71VD1	FDF100VD2	FDF100VD2
Outdoor unit			FDC71VNP	FDC90VNP1	FDC100VNP
Power source			1 Phase 220-240V, 50Hz / 220V, 60Hz		
Nominal cooling capacity (Min-Max)			kW 7.1 ( 1.4 ~ 7.1 )	9.0 ( 1.9 ~ 9.0 )	10.0 ( 2.8 ~ 11.2 )
Nominal heating capacity (Min-Max)			kW 7.1 ( 1.0 ~ 7.1 )	9.0 ( 1.5 ~ 9.0 )	11.2 ( 2.5 ~ 12.5 )
Power consumption			Cooling/Heating kW 2.67 / 2.04	2.81 / 2.25	3.19 / 3.09
EER/COP			Cooling/Heating 2.66 / 3.48	3.20 / 4.00	3.13 / 3.62
Inrush current			A 5	5	5
Max. current			14.5	18.0	21.0
Sound power level*1	Indoor	Cooling/Heating	61 / 61	65 / 65	65 / 65
	Outdoor	Cooling/Heating	67 / 67	69 / 69	70 / 70
Sound pressure level*1	Indoor	Cooling (P-Hi/Hi/Me/Lo)	dB(A) 42 / 39 / 35 / 33	54 / 50 / 48 / 44	54 / 50 / 48 / 44
		Heating (P-Hi/Hi/Me/Lo)		54 / 50 / 48 / 44	54 / 50 / 48 / 44
	Outdoor	Cooling/Heating	54 / 54	57 / 55	57 / 61
		Cooling (P-Hi/Hi/Me/Lo)	20 / 18 / 16 / 14	29 / 26 / 23 / 19	29 / 26 / 23 / 19
Air flow	Indoor	Heating (P-Hi/Hi/Me/Lo)	20 / 18 / 16 / 14	29 / 26 / 23 / 19	29 / 26 / 23 / 19
		Cooling/Heating	36 / 36	63 / 49.5	75 / 79
	Outdoor	Cooling/Heating	36 / 36	63 / 49.5	75 / 79
Exterior dimensions	Indoor	HeightxWidthxDepth	mm	1,850 x 600 x 329	
	Outdoor			640 x 800(+71) x 290	750 x 880(+88) x 340
Net weight	Indoor		kg	49	52
	Outdoor			45	57
Ref.piping size	Liquid/Gas	ømm	6.35(1/4") / 12.7(1/2")		
Refrigerant line (one way) length			m	Max.23	Max.30
Vertical height differences			Outdoor is higher/lower	m Max.20 / Max.20	
Outdoor operating temperature range	Cooling	°CDB	-15~46*2		
	Heating	°CWB	-15~20		
Air filter, Q'ty			Plastic net x1(Washable)		
Remote control			wired:RC-E5 (installed) wireless:RCN-KIT4-E2 (option)		

### NOTES:

The data are measured under the following conditions(R32 : ISO-T1, -H1 / R410A : ISO-T1).

Cooling:Indoor temp. of 27°CDB, 19°CWB, and outdoor temp. of 35°CDB. Heating:Indoor temp. of 20°CDB, and outdoor temp. of 7°CDB, 6°CWB.

\*1 : Indicates the value in an anechoic chamber. During operation these values are somewhat higher due to ambient conditions.

\*2 : If a cooling operation is conducted when the outdoor air temperature is -5°C or lower, the outdoor unit should be installed at a place where it is not influenced by natural wind. If wind blows, the low pressure will drop and compressor frequency will increase, this will cause the capacity to drop and may cause the unit to break down.



# Outdoor Unit Dimensions (Unit:mm)

SRC40ZSX-W1, 50ZSX-W2, 60ZSX-W1  
SRC40ZSX-S, 50ZSX-S, 60ZSX-S

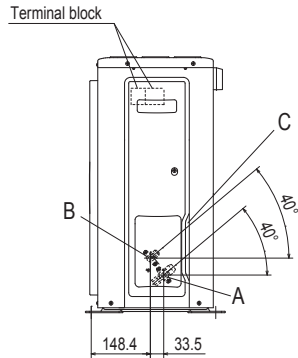
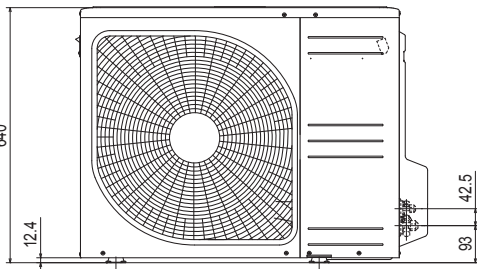
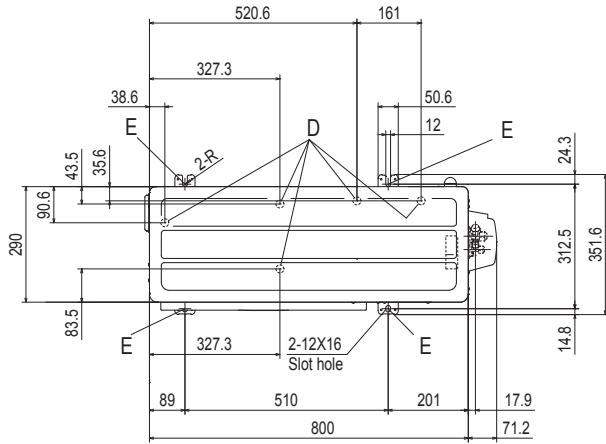

Symbol	Content	
A	Service valve connection (Gas side)	φ 12.7(1/2")(Flare)
B	Service valve connection (Liquid side)	φ 6.35(1/4")(Flare)
C	Pipe/cable draw-out hole	
D	Drain discharge hole	φ 20×5 places
E	Anchor bolt hole	M10-12×4 places

Notes

- (1) The unit must not be surrounded by walls on the four sides.
- (2) The unit must be fixed with anchor bolts. An anchor bolt must not protrude more than 15mm.
- (3) If the unit is installed in the location where there is a possibility of strong winds, place the unit such that the direction of air from the outlet gets perpendicular to the wind direction.
- (4) Leave 200mm or more space above the unit.
- (5) The wall height on the outlet side should be 1200mm or less.
- (6) The model name label is attached on the front side of the unit.

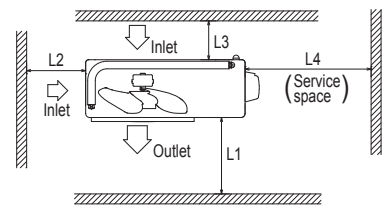

Minimum installation space

Examples Installation	I	II	III	IV
Size				
L1	Open	280	280	180
L2	100	75	Open	Open
L3	100	80	80	80
L4	250	Open	250	Open

FDC71VNX-W  
FDC71VNX

Symbol	Content	
A	Service valve connection (gas side)	φ 15.88 (5/8") (Flare)
B	Service valve connection (liquid side)	φ 9.52 (3/8") (Flare)
C	Pipe/cable draw-out hole	
D	Drain discharge hole	φ 20 × 3places
E	Anchor bolt hole	M10 × 4places

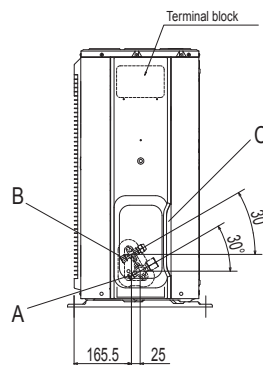
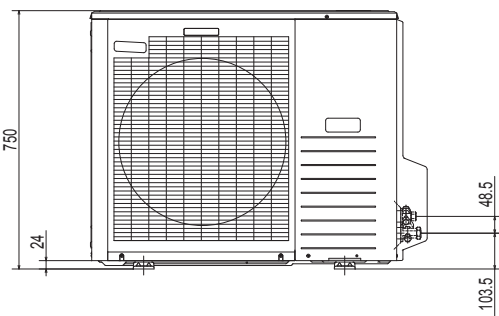
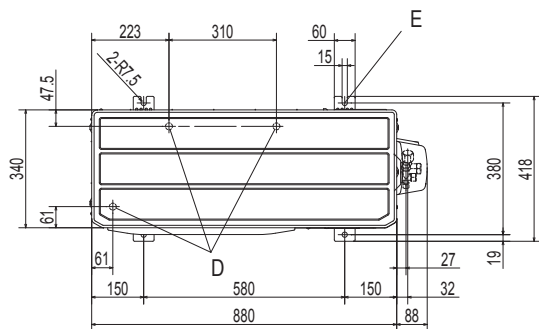

Notes

- (1) It must not be surrounded by walls on the four sides.
- (2) The unit must be fixed with anchor bolts. An anchor bolt must not protrude more than 15mm.
- (3) Where the unit is subject to strong winds, lay it in such a direction that the blower outlet faces perpendicularly to the dominant wind direction.
- (4) Leave 1m or more space above the unit.
- (5) A wall in front of the blower outlet must not exceed the units height.
- (6) The model name label is attached on the lower right corner of the front panel.

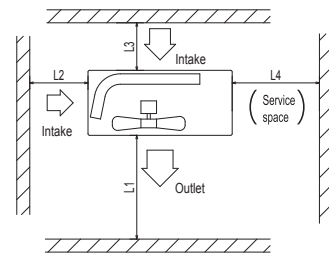

Minimum installation space

Examples of relation	I	II	III
Dimensions			
L1	Open	Open	500
L2	300	250	Open
L3	100	150	100
L4	250	250	250

# Outdoor Unit Dimensions (Unit:mm)

FDC100VNX-W, 125VNX-W, 140VNX-W, 100VSX-W, 125VSX-W, 140VSX-W

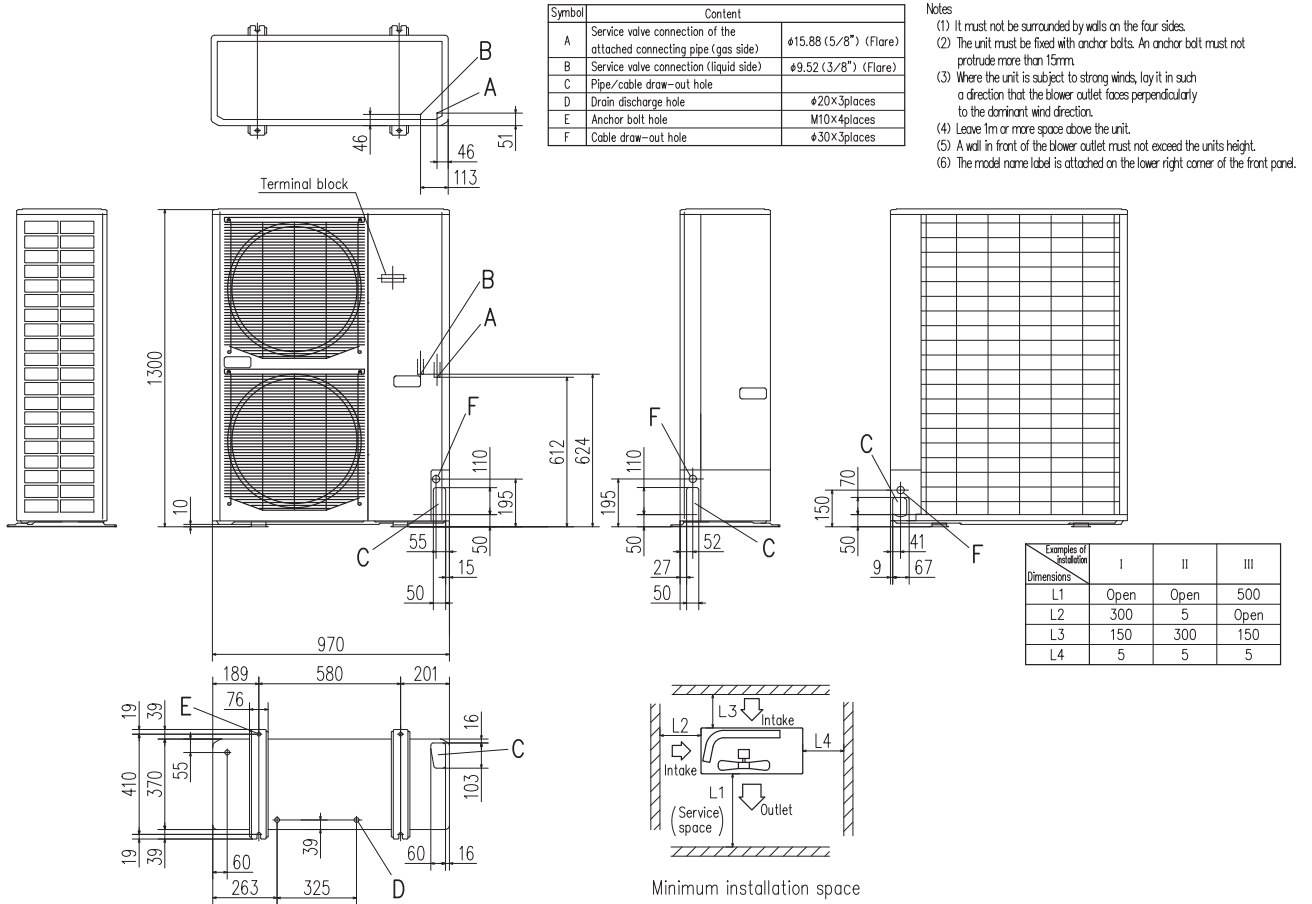

- Notes
- (1) It must not be surrounded by walls on the four sides.
  - (2) The unit must be fixed with anchor bolts. An anchor bolt must not protrude more than 15mm.
  - (3) Where the unit is subject to strong winds, lay it in such a direction that the blower outlet faces perpendicularly to the dominant wind direction.
  - (4) Leave 1m or more space above the unit.
  - (5) A wall in front of the blower outlet must not exceed the units height.
  - (6) The model name label is attached on the lower right corner of the front panel.

FDC100VNX, 125VNX, 140VNX, 100VSX, 125VSX, 140VSX

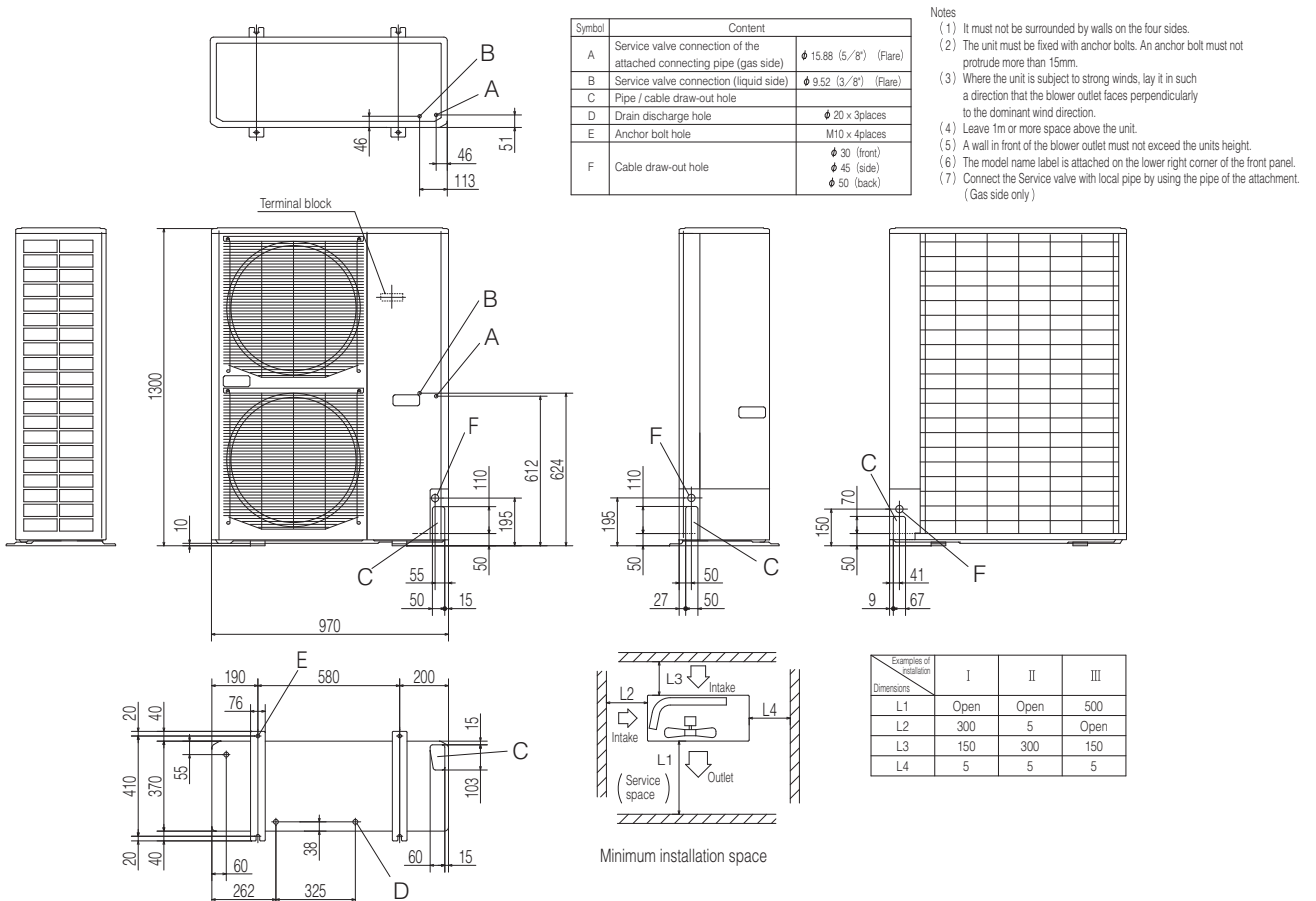

- Notes
- (1) It must not be surrounded by walls on the four sides.
  - (2) The unit must be fixed with anchor bolts. An anchor bolt must not protrude more than 15mm.
  - (3) Where the unit is subject to strong winds, lay it in such a direction that the blower outlet faces perpendicularly to the dominant wind direction.
  - (4) Leave 1m or more space above the unit.
  - (5) A wall in front of the blower outlet must not exceed the units height.
  - (6) The model name label is attached on the lower right corner of the front panel.
  - (7) Connect the Service valve with local pipe by using the pipe of the attachment. (Gas side only)

FDC100VNA-W, 125VNA-W, 140VNA-W, 100VSA-W, 125VSA-W, 140VSA-W  
 FDC100VNA, 125VNA, 140VNA, 100VSA, 125VSA, 140VSA

Symbol	Content	
A	Service valve connection (gas side)	φ15.88 (5/8") (Flare)
B	Service valve connection (liquid side)	φ9.52 (3/8") (Flare)
C	Pipe/cable draw-out hole	
D	Drain discharge hole	φ20×3places
E	Anchor bolt hole	M10×4places
F	Cable draw-out hole	φ30×3places

- Notes
- (1) It must not be surrounded by walls on the four sides.
  - (2) The unit must be fixed with anchor bolts. An anchor bolt must not protrude more than 15mm.
  - (3) Where the unit is subject to strong winds, lay it in such a direction that the blower outlet faces perpendicularly to the dominant wind direction.
  - (4) Leave 1m or more space above the unit.
  - (5) A wall in front of the blower outlet must not exceed the units height.
  - (6) The model name label is attached on the lower right corner of the front panel.

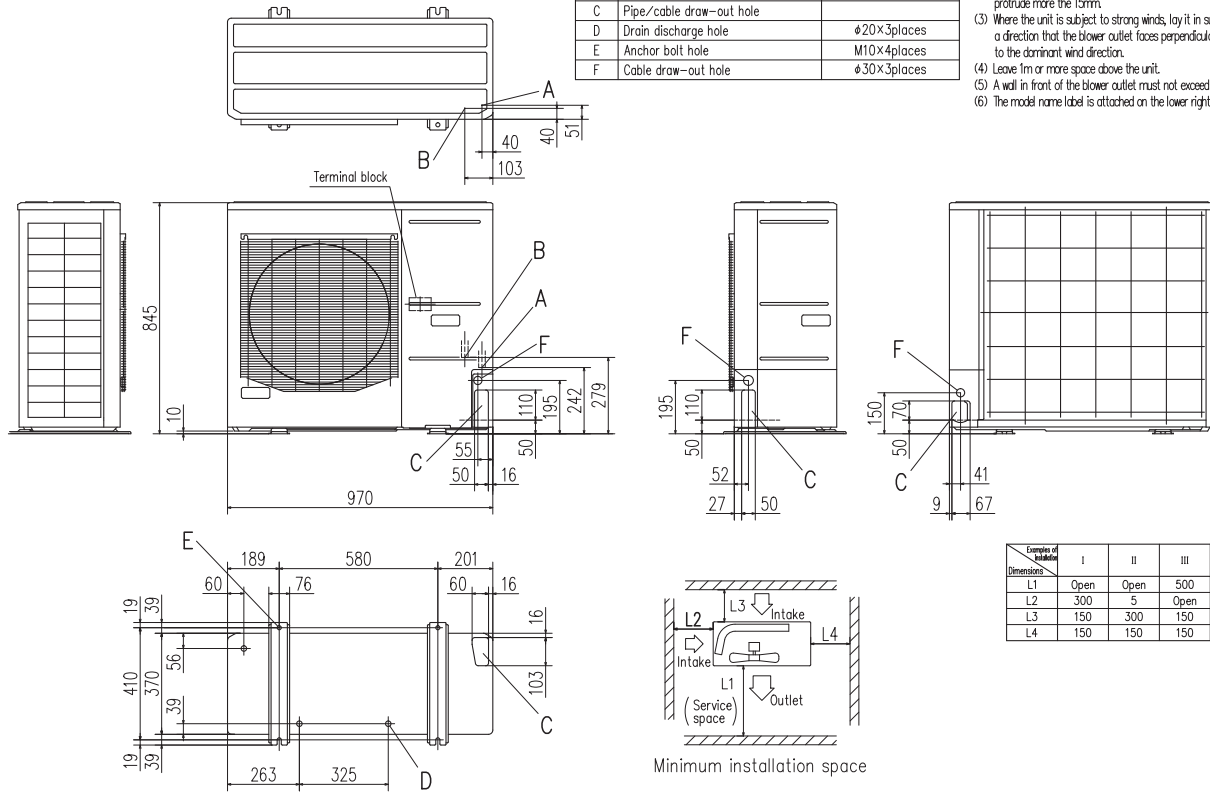

FDC200VSA

Symbol	Content	
A	Service valve connection of the attached connecting pipe (gas side)	φ19.05 (3/4") (Flare)
B	Service valve connection (liquid side)	φ9.52 (3/8") (Flare)
C	Pipe/cable draw-out hole	
D	Drain discharge hole	φ20×3places
E	Anchor bolt hole	M10×4places
F	Cable draw-out hole	φ30 (front) φ30 (side) φ30 (back)

- Notes
- (1) It must not be surrounded by walls on the four sides.
  - (2) The unit must be fixed with anchor bolts. An anchor bolt must not protrude more than 15mm.
  - (3) Where the unit is subject to strong winds, lay it in such a direction that the blower outlet faces perpendicularly to the dominant wind direction.
  - (4) Leave 1m or more space above the unit.
  - (5) A wall in front of the blower outlet must not exceed the units height.
  - (6) The model name label is attached on the lower right corner of the front panel.
  - (7) Connect the Service valve with local pipe by using the pipe of the attachment. (Gas side only)
  - (8) Regarding attaching the pipe of accessories, refer to an attached installation manual.

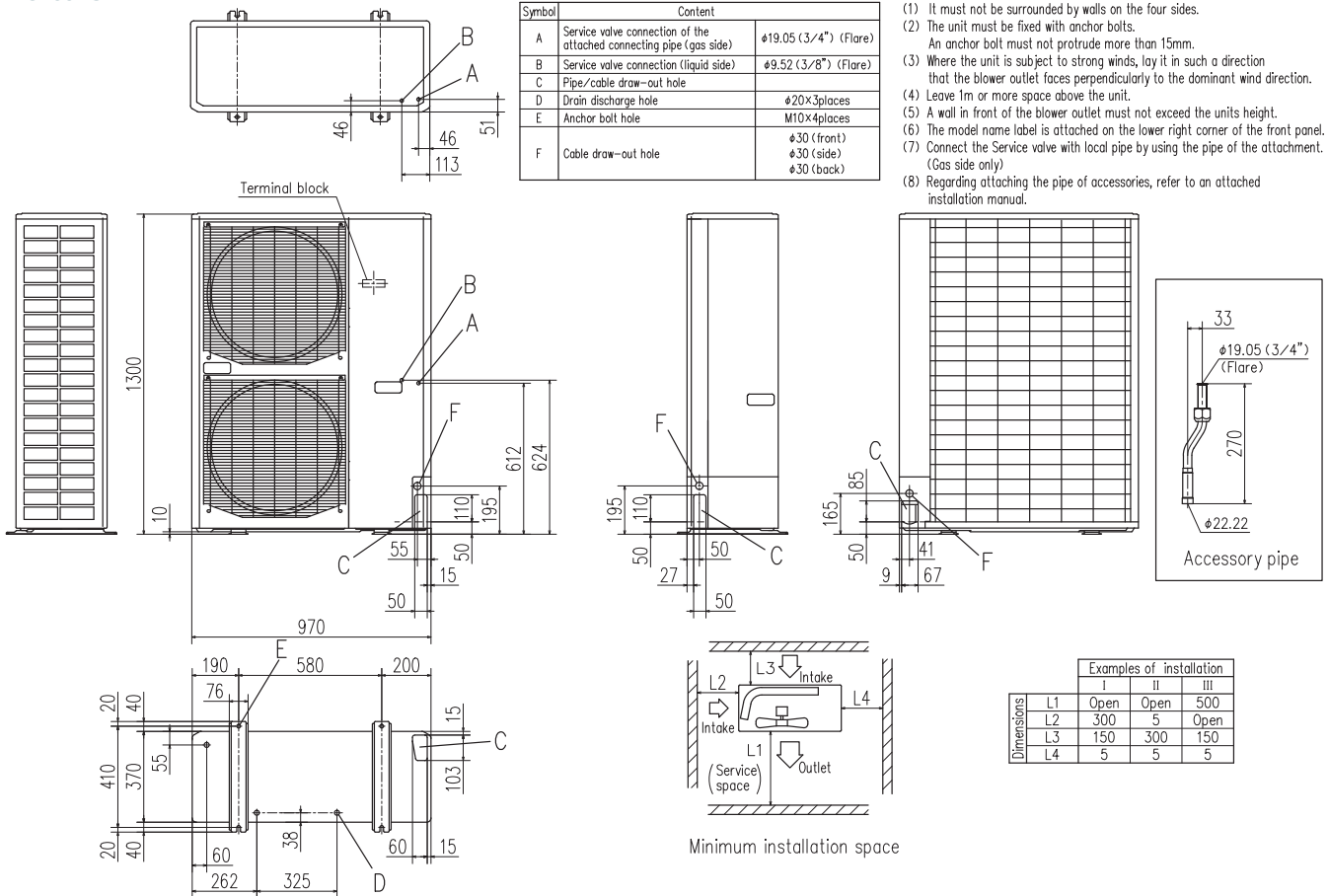

# Outdoor Unit Dimensions (Unit:mm)

FDC200VSA-W, 250VSA-W, FDC280VSA-W  
FDC250VSA

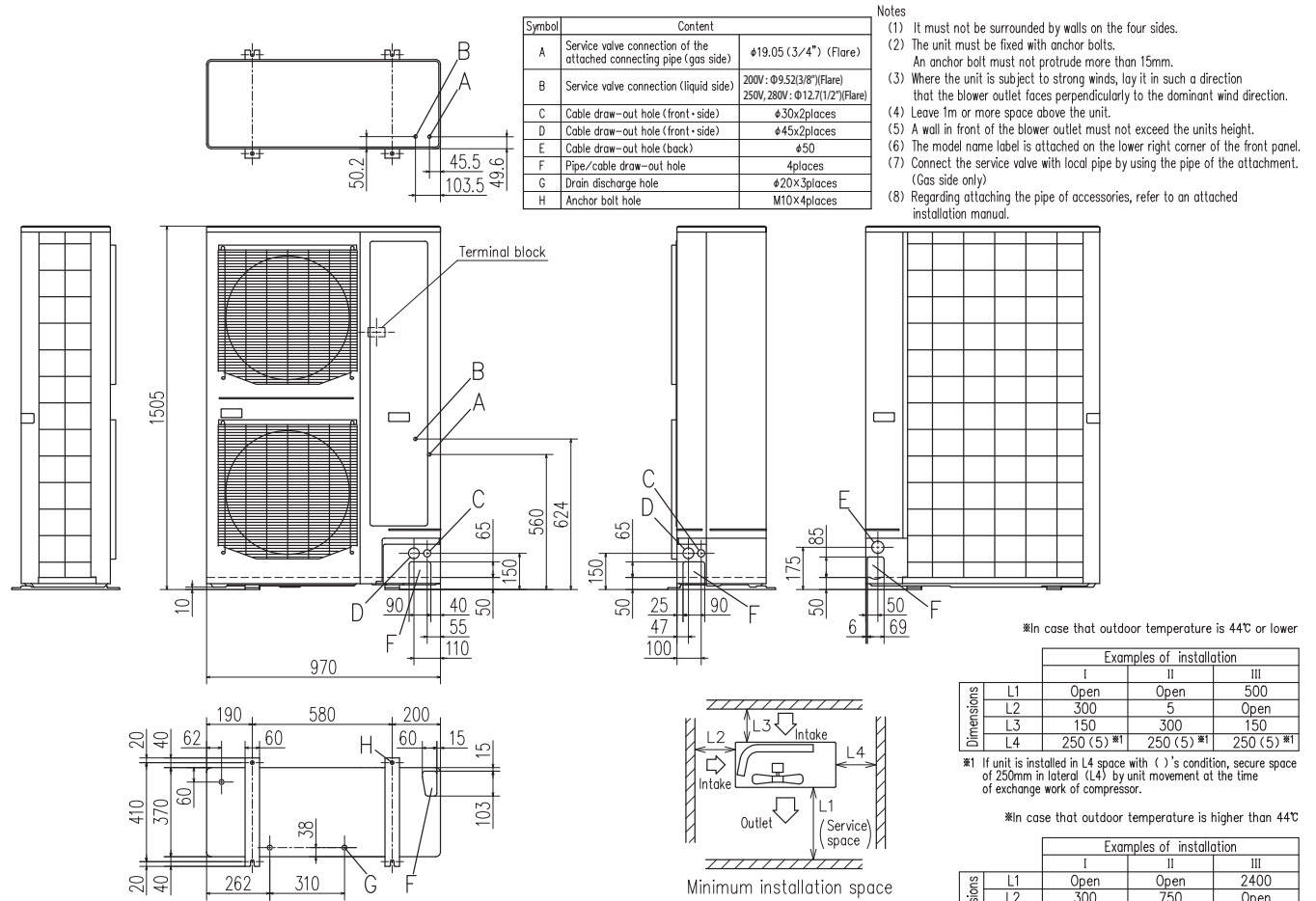

FDC71VNP-W  
FDC71VNP

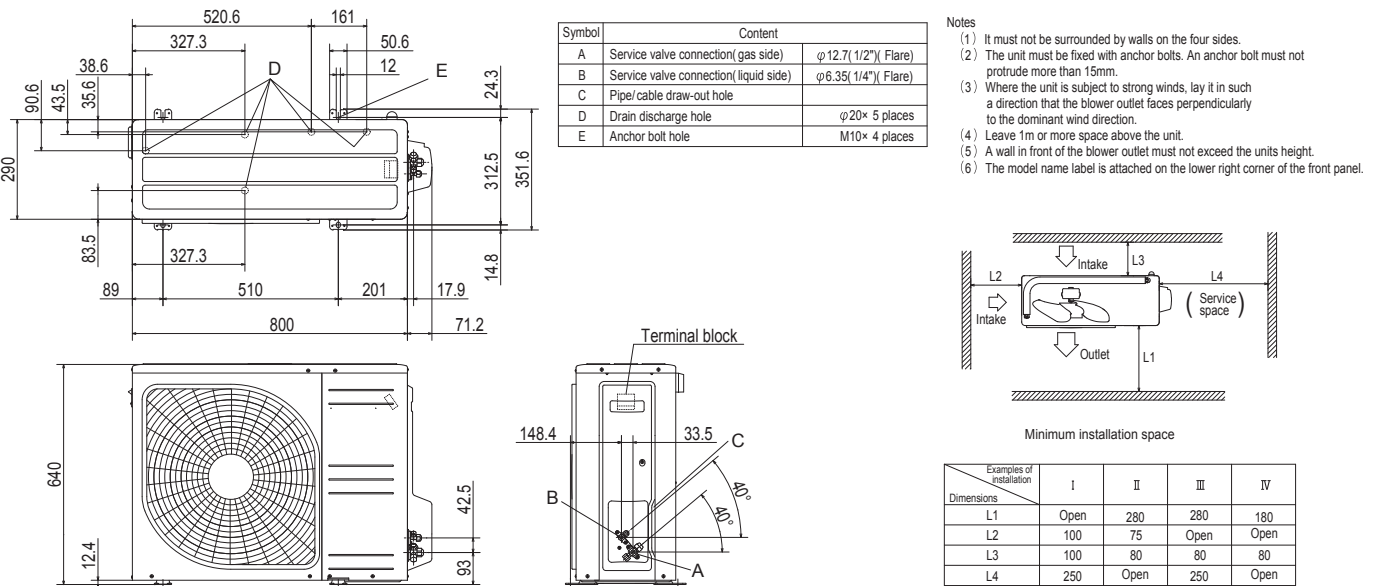

FDC90VNP-W, 100VNP-W  
FDC90VNP1

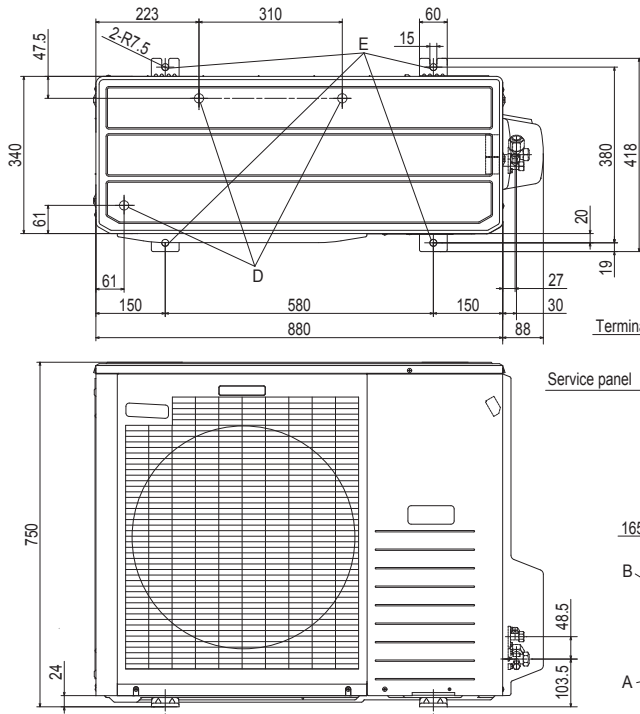

Notes

- (1) It must not be surrounded by walls on four sides.
- (2) The unit must be fixed with anchor bolts. An anchor bolt must not protrude more than 15mm.
- (3) Where the unit is subjected to strong winds, lay it in such a direction that the blower outlet faces perpendicularly to the dominant wind direction.
- (4) Leave 1m or more space above the unit.
- (5) A wall in front of the blower outlet must not exceed the unit's height.
- (6) The model name label is attached on the lower right corner of the front panel.

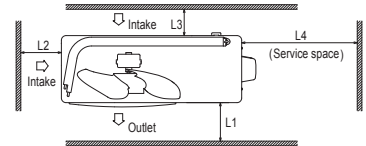

Minimum installation space

Examples of installation Dimensions	I	II	III
L1	Open	Open	500
L2	300	250	Open
L3	100	150	100
L4	250	250	250

Symbol	Content	
A	Service valve connection (gas side)	φ 15.88 (5/8") (Flare)
B	Service valve connection (liquid side)	φ 6.35 (1/4") (Flare)
C	Pipe / cable draw-out hole	
D	Drain discharge hole	φ20 x 3 places
E	Anchor bolt hole	M10 x 4 places

FDC125VNP-W  
FDC100VNP

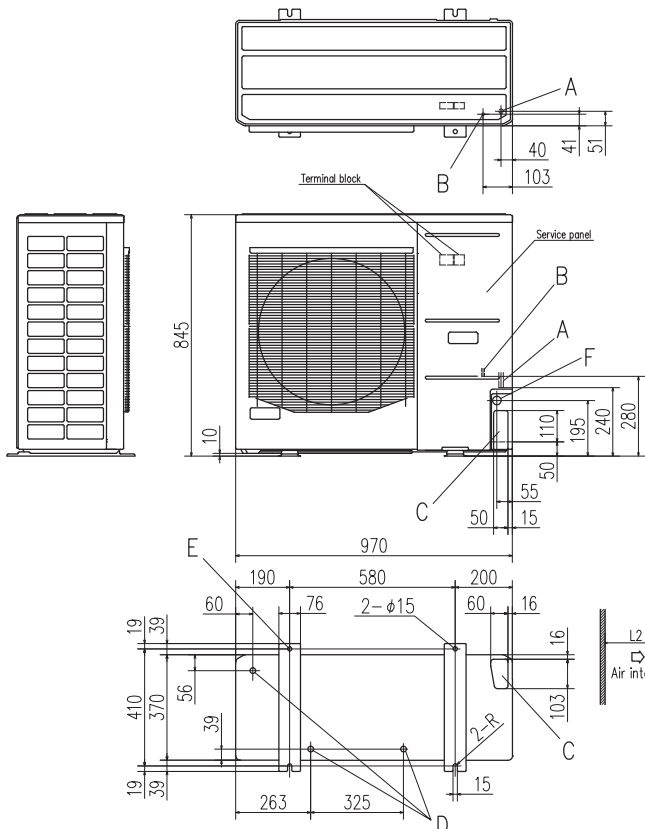

Symbol	Content	
A	Service valve connection (gas side)	φ15.88 (5/8") (Flare)
B	Service valve connection (liquid side)	φ9.52 (3/8") (Flare)
C	Pipe / cable draw-out hole	
D	Drain discharge hole	φ20x3 places
E	Anchor bolt hole	M10x4 places
F	Cable draw-out hole	φ30x3 places

Notes

- (1) It must not be surrounded by walls on the four sides.
- (2) The unit must be fixed with anchor bolts. An anchor bolt must not protrude more than 15mm.
- (3) Where the unit is subject to strong winds, lay it in such a direction that the blower outlet face is perpendicular to the dominant wind direction.
- (4) Leave 1m or more space above the unit.
- (5) A wall in front of the blower outlet must not exceed the unit's height.
- (6) The model name label is attached on the service panel.

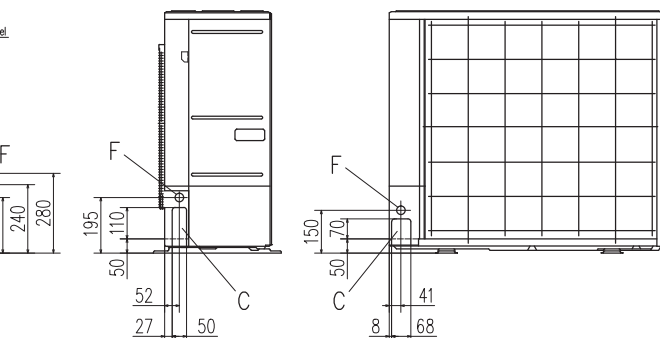

The height of a wall is 1200mm or less

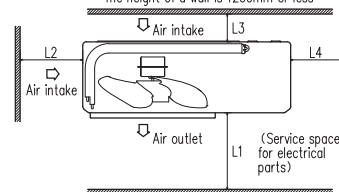

Minimum installation space

Examples of installation Dimensions	I	II	III
L1	Open	Open	500
L2	300	250	Open
L3	100	150	100
L4	250	250	250

# Control Systems

## Remote Control line up

wired	indoor unit	remote control	wireless	indoor unit	remote control	indoor unit	remote control
	All models	RC-EX3A		FDT	RCN-T-5BW-E2 RCN-T-5BB-E2	FDE	RCN-E-E3
		RC-E5	FDTC	RCN-TC-5AW-E3	FDU,FDUM,PDF	RCN-KIT4-E2	
		RCH-E3					

### Wired remote control

option

## RC-EX3A Intuitive touch controller with Liquid Crystal Display

### User friendly

- LCD panel with light tap operation introduced as the industry's first
- Simple interface with only three buttons

### Easy view

- Big LCD with 3.8 inch full dot display
- Back light function
- Multi language display (12 languages)

#### Operation mode setting screen

The desired operation mode can be selected by simply tapping this button.

**Run / Stop**

#### Setting temperature screen

You can select the temperature as desired by tapping ▲ ▼ button.

#### High power operation

The highest capacity operation (Max 15 minutes)

- Increasing compressor speed
- Increasing air flow volume

#### Energy-saving operation

- Changes set temperature. At 28°C in cooling mode and 22°C in heating mode, 25°C in auto mode.
- Operation correction by outdoor temperature

## Main functions

	Function name	Description
Economy & Timer	<b>Energy-saving operation</b>	Since the capacity is controlled automatically based on the outdoor temperature, energy can be saved without losing comfort.
	<b>Sleep timer</b>	Set the time period from start to stop of operation. The selectable range of setting time is from 30 to 240 minutes (at 10-minute intervals).
	<b>Set temperature auto return</b>	The temperature automatically returns to the previously set temperature.
	<b>Set ON timer by hour</b>	When the set time elapses, the air conditioner starts.
	<b>Set OFF timer by hour</b>	When the set time elapses, the air conditioner stops.
	<b>Set ON timer by clock</b>	The air conditioner starts at the set time.
	<b>Set OFF timer by clock</b>	The air conditioner stops at the set time.
	<b>Weekly timer</b>	On or Off timer can be set on a weekly basis.
	<b>Peak-cut timer</b>	Capacity control can be set by using peak cut function on RC-EX3A for better energy saving. Five-step capacity control is available.
	<b>Home leave operation</b>	When the unit is not used for a long period of time, the room temperature is maintained at a moderate level, avoiding extremely hot or cool temperatures.
Comfort	<b>Big LCD &amp; Touch screen panel</b>	Large 3.8 inch screen has resulted in improved visibility and operability.
	<b>Easy modification of individual flap control</b>	User can visually confirm and set the direction of louvers using the visual display on the remote control.
	<b>Automatic fan speed *1</b>	The micro-computer automatically adjusts the airflow effectively to follow the changes of return air temperature.
	<b>Temp increment setting</b>	Temperature increment for the change of the set temp can be changed.
	<b>Silent mode</b>	Set the period of time to operate the Outdoor unit with prioritizing the quietness.

\*1 Cannot be used when a centralized control remote is connected.

	Function name	Description
Convenience	<b>Function switch *1</b>	The function switch allows user to select and set two functions among available functions .
	<b>Favourite setting *1</b>	Operation mode, set temperature, fan speed and air flow direction automatically adjust to the programmed favourite setting.
	<b>Adjusting Brightness of the operation lamp</b>	The brightness of the background light can be adjusted by 10 stages.
	<b>LCD contrast setting</b>	This function allows user to adjust LCD display contrast.
	<b>High power operation</b>	High Power Mode increases the unit operating ability for 15 minutes to quickly adjust the room temperature to a comfortable level.
	<b>Back light setting</b>	This convenient function allows user to see controls under low light conditions.
	<b>Administrator settings</b>	This function only allows specific individuals to operate the unit.
	<b>Setting temp range</b>	Limited range of setting temperature in the heating or the cooling operation can be selected.
	<b>External Input / Output Function</b>	The external input/output of indoor unit by remote controller can set input/output based on user needs.
	<b>Select the language</b>	Set the language to be displayed on the remote control.
Service	<b>USB connection (mini-B)</b>	This function allows batch input of schedule timer settings and other settings involving a large amount of data.
	<b>Error code display</b>	This function allows user to check information displayed when abnormal function of the unit occurs.
	<b>Operation data display</b>	Displays various types of air conditioner operation data in real time.
	<b>Contact company display</b>	Address of the service contact is displayed.
	<b>Filter sign</b>	Announces the due time for cleaning of the air filter.
	<b>Static pressure adjustment</b>	Allows user to adjust duct static pressure using the remote control.
	<b>Backup Control</b>	Allows for rotation control, fault backup control, and capacity backup control.

**Wired remote control**

option

# RC-E5



The RC-E5 control enables extensive access to service and maintenance technical data combined with easy to use functions and a clear LCD display.

**Weekly timer function as standard**

RC-E5 provides (as a standard feature) a weekly timer, which allows one-week operation schedules to be registered. A user can specify up to four times a day to start/stop the air conditioner. (Temperature setting is also possible with the timer).

**Timer operation**

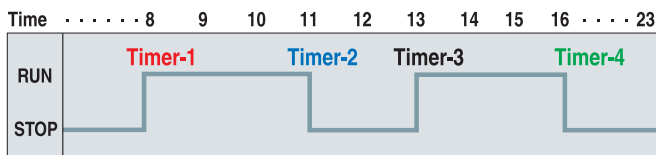

**Run hour meters to facilitate maintenance checking**

RC-E5 stores operation data when an anomaly occurs and indicates the error on the LCD. It also displays cumulative operation hours of the air conditioner and compressor since commissioning.

**Room temperature controlled by the remote control sensor**

The temperature sensor is housed in the top section of the remote control unit. This arrangement has improved the sensitivity of the remote control unit's sensor, which permits more finely controlled air conditioning.

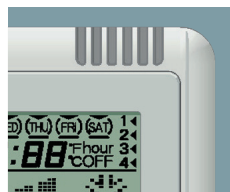

**Adjustable set temperature ranges**

RC-E5 allows the upper and lower limits of a set temperature range to be specified separately. By adjusting a set temperature range, you can ensure energy saving air conditioning by avoiding excessive cooling or heating.

Changeable range	
<b>Upper limit</b>	<b>20~30°C</b> (effective for heating operation)
<b>Lower limit</b>	<b>18~26°C</b> (effective for non-heating operation)

**Simple remote control**

option

# RCH-E3 (wired)



Designed specially for hotel rooms, the controller's buttons are limited only to the minimum required functions such as ON/OFF, mode, temperature setting and fan speed. It is really simple and easy to use.

\* RCH-E3 is not applicable to the Individual flap control system. When RCH-E3 is used, the fan has 3 speed settings (Hi-Me-Lo) only.

**Up to 16 units**

It can control up to 16 indoor units, by pressing the AIR CON No. button.

**AUTO restart**

This function allows starting the air conditioner automatically when power supply is restored after power failure or by turning on the power switch.

**Wireless remote control**

option

## RCN-T-5BW-E2 RCN-T-5BB-E2

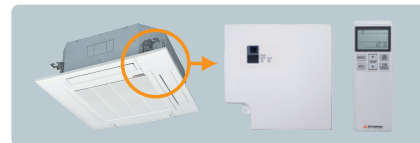

For wireless control simply insert the infrared receiver kit on a corner of the panel.

\* Wireless remote control is not applicable to the Individual flap control system.

## RCN-TC-5AW-E3



## RCN-KIT4-E2



## RCN-E-E3



**Thermistor**

option

# SC-THB-E3

In case the sensor integrated in the indoor unit or in the remote controller is unable to sense the room temperature correctly, or an individual controller in each room is not required but a temperature sensor is (as when a central control system is in place), install SC-THB-E3 in an adequate location in the room.



# Air Handling Unit Interface

## AHU-KIT-SP

The AHU controller will function as an interface between MHI's PAC outdoor units and locally produced heat exchanger for Air Handling Unit (AHU).

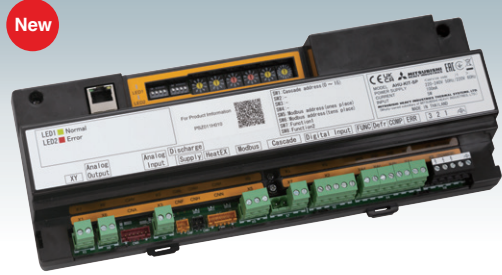

- Compact AHU interface for MHI's Split system
- 0-10V/4-20mA capacity control
- Various external I/O
- Modbus connection
- Cascade control
- Set temperature control

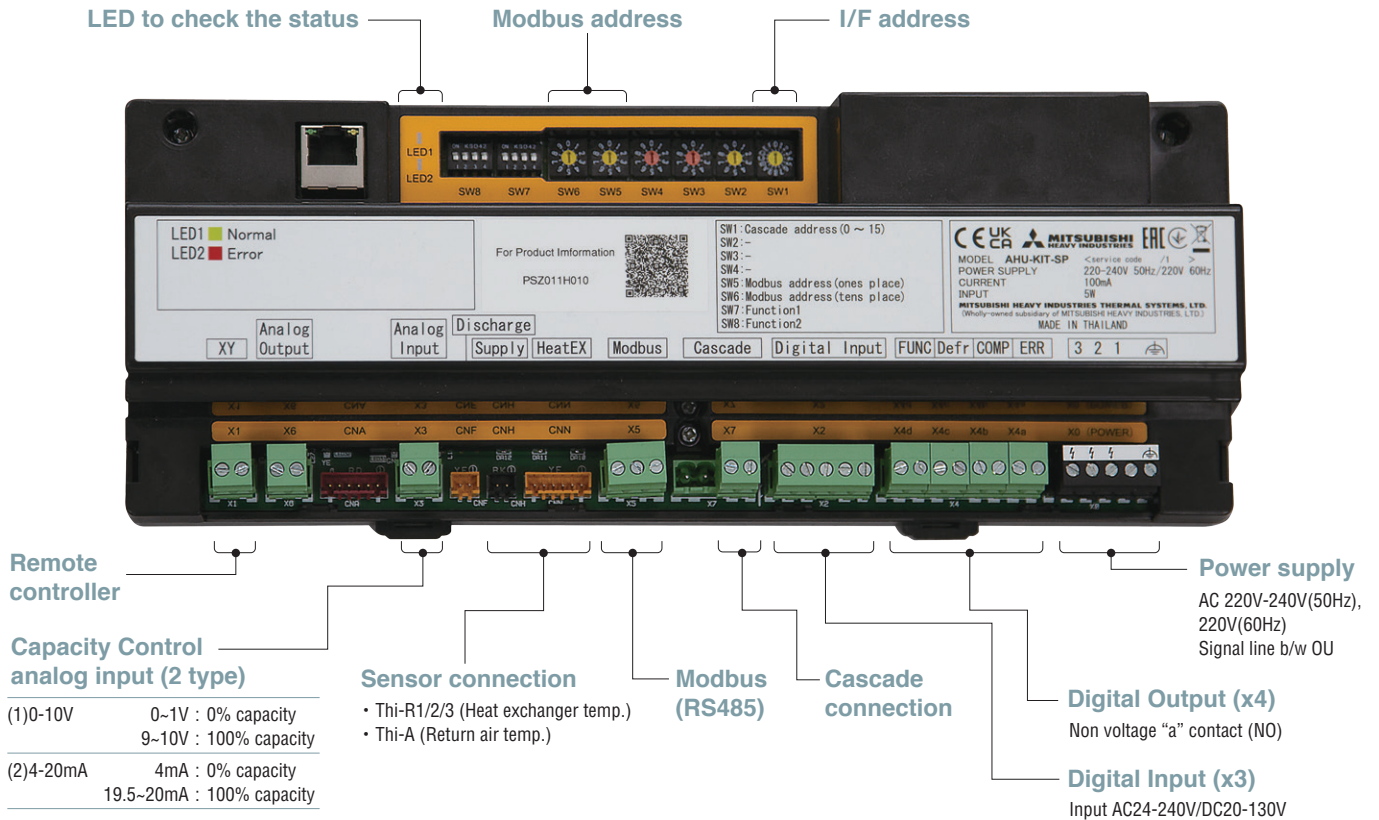

### Main components



### Main functions

Model	AHU-KIT-SP	
Size	W290 x H109.5x D57mm	
External Input	Capacity control	○ 0-10V DC, 4-20mA(0-100%)
	Cooling / Heating	○
	Operation On/Off	○
	Emergency stop	○
External Output	Comp On/Off	○
	Run/Stop	○
	Defrost On/Off	○
	Error	○
Modbus (RS-485)	○	
Cascade connection	○ Max 16	
Standard	EN60335-1	

### Compatibility PAC & RAC outdoor unit will be in scope.

Capacity	R32 	R410A 
Small	SRC40/50/60ZSX-W1,W2,WA	SRC40/50/60ZSX-S,SA
	FDC71VNX-W	FDC71VNX
Medium	FDC100/125/140VNA-W	FDC100/125/140VNA
	FDC100/125/140VSA-W	FDC100/125/140VSA
	FDC100/125/140VNX-W	FDC100/125/140VNX
	FDC100/125/140VSX-W	FDC100/125/140VSX
Large	FDC200/250/280VSA-W	FDC200/250VSA



### System Examples & Advantages

#### Ex1. General AHU

1. 0-10V/4-20mA capacity control
2. Various I/O for better control
3. R/C can be removed

Compatible with market standard AHU controller.  
Provide wide flexibility for AHU solution.

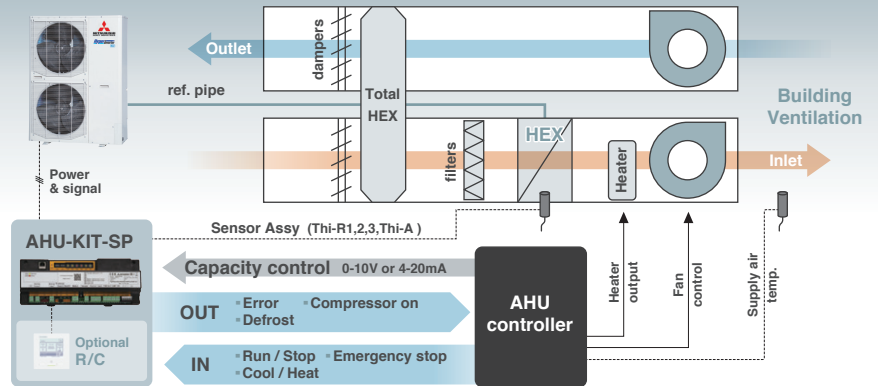

#### Ex2. Modbus AHU

1. Modbus connection
2. Same control as external I/O

BMS connectability without any extra device.

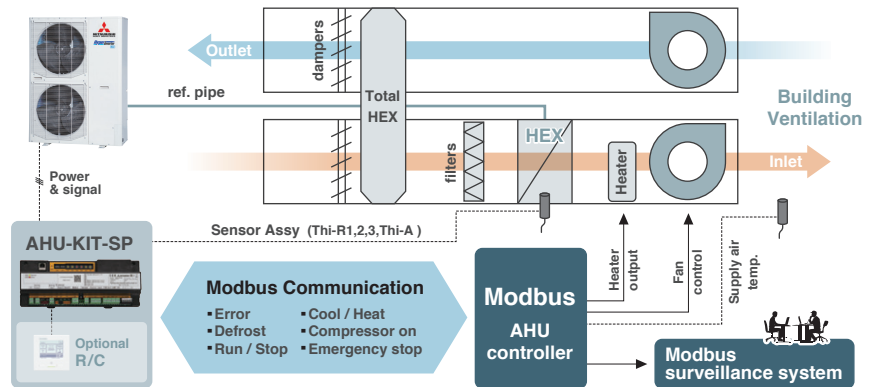

#### Ex3. Simple AHU

1. Remote controller connection
2. Adequate external input/output

Simple stand-alone AHU control by set temperature control from RC.

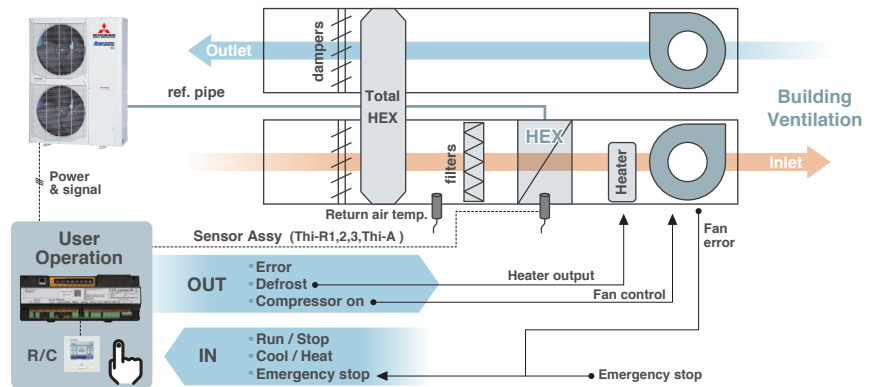

#### Ex4. Big capacity AHU

Cascade control provides wide range of AHU capacity with small footprint. Multiple outdoor unit increase system reliability and efficiency.

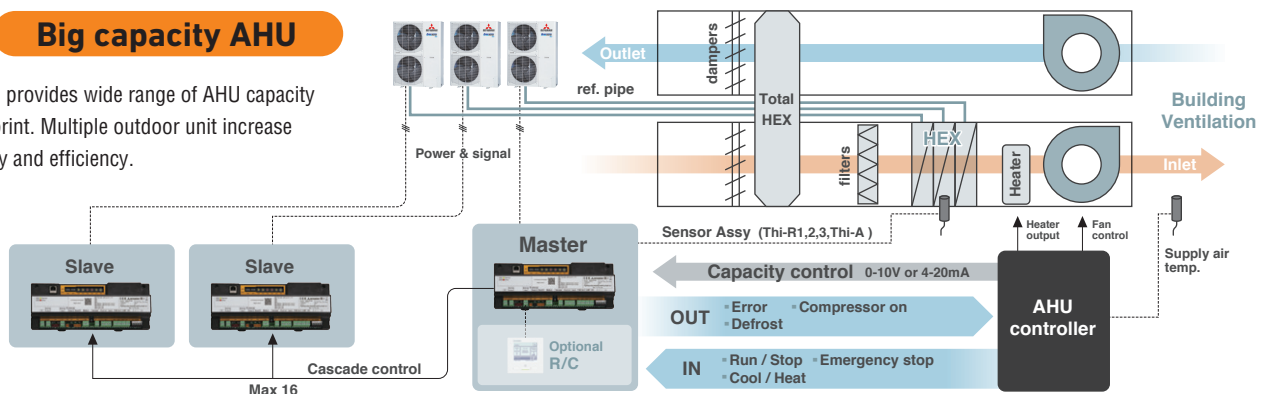

# SUPERLINK II

## - Control Systems -

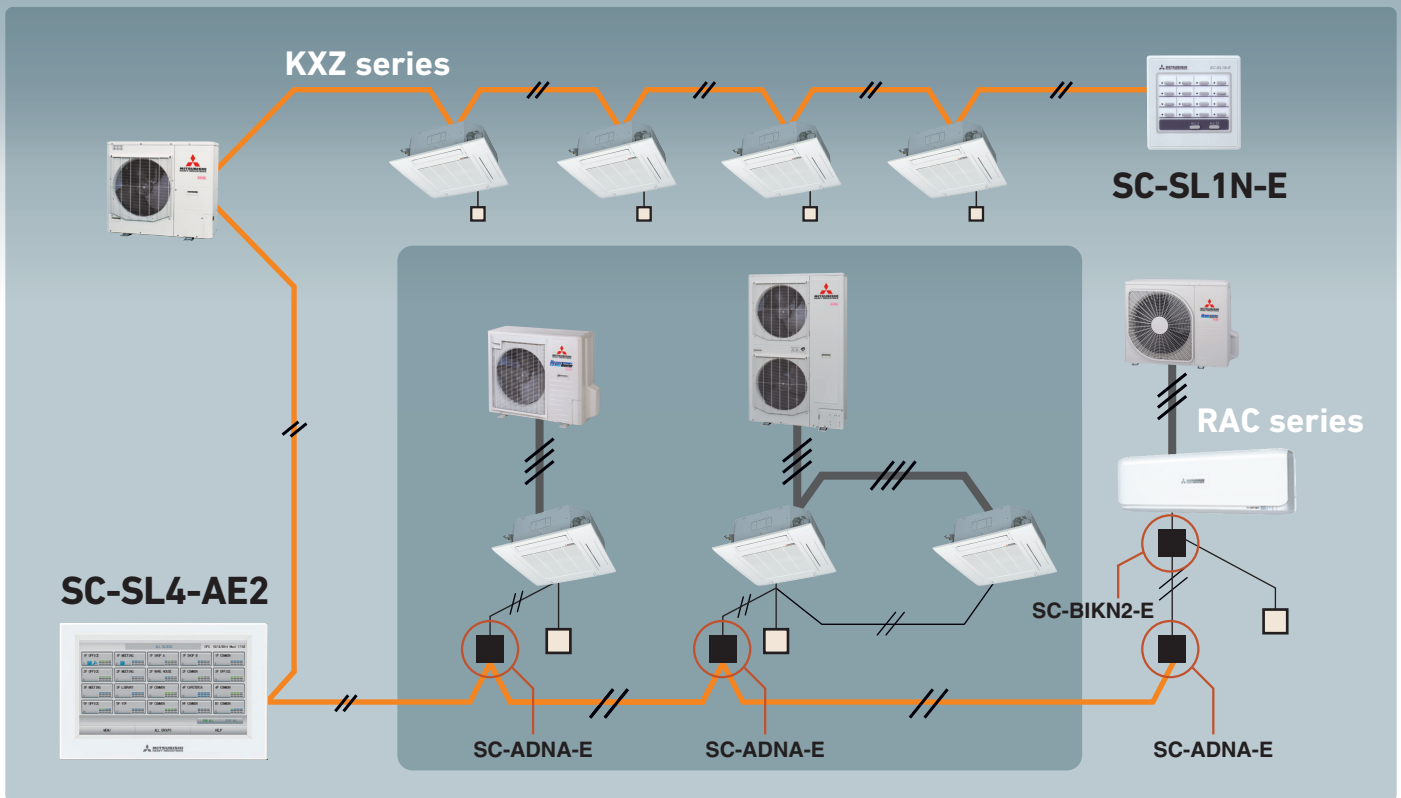

## Central Control



### SC-SL1N-E

Start/stop control of up to 16 indoor units is possible either individually or collectively. With simple operations, you can achieve centralized control.

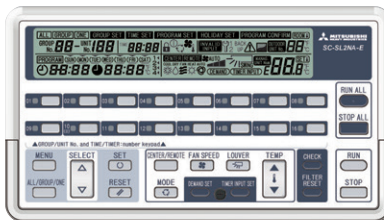

### SC-SL2NA-E

Centralized control of up to 64 indoor units. Including weekly timer function as standard.

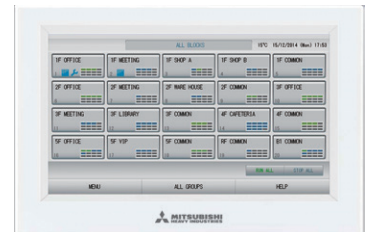

New

### SC-SL4-AE3, BE3

Easy operation thanks to with a large colour LCD and touch panel. Up to 128 indoor units can be controlled, when SUPERLINK-II systems are connected.

## Building Management Systems

Production by order



Users can manage up to 1024 units by connecting the four devices !!

### SC-WBGW256\*

Web gateway  
BACnet gateway

SC-WBGW256, up to 256 cells (some cells can have two or more indoor units and total number of indoor units can be up to 256 units) are controlled from the Internet Explorer and centrally from Building Management Systems.



### SC-LGWNB\*

LonWorks gateway

Up to 96 indoor units can be integrated to a central control point via the building management system network.

\* Additional engineering service is required. Please consult your dealer when using these system.

# SUPERLINK E BOARD (SC-ADNA-E)

This board is used when conducting control of the single package (wired remote control unit) 1-type series using a network option (SC-SL1N-E, SC-SL2NA-E, etc).

- (1) Functions**
- (a) Transmits the settings from the network option to the indoor units.
  - (b) Returns the priority indoor unit data in response to a data request from the network option.
  - (c) Inspects the error status of connected indoor units and transmits the inspection codes to the network option.
  - (d) A maximum of 16 units can be controlled (if in the same operation mode).

## (2) Wiring connection diagram

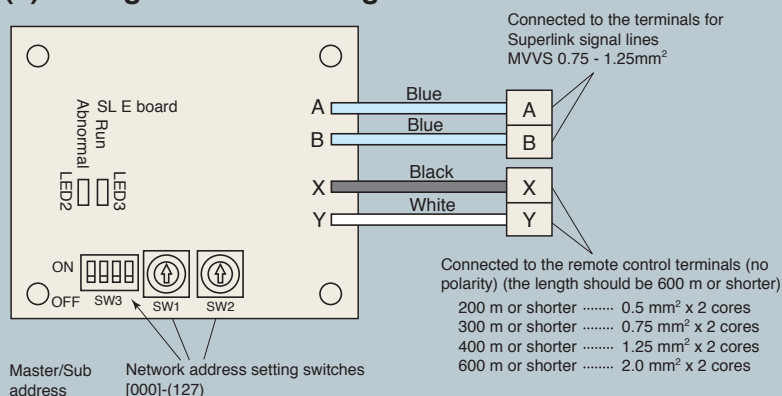

## (3) Metal box dimension (unit:mm)

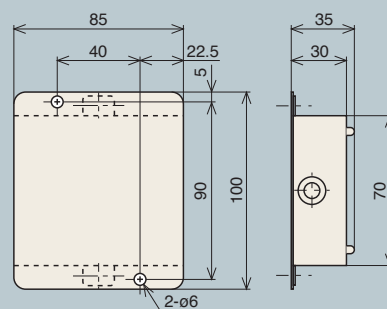

### Basic Connections

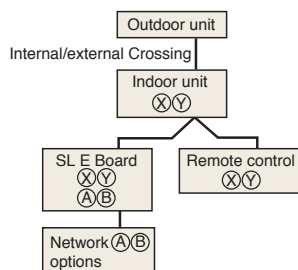

### Plural Controls by Multiple Remote Controls. Mixture of Multiple Units

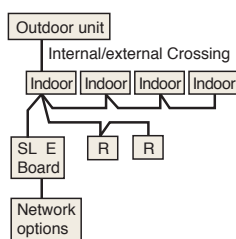

- Transmit the information of plural "Master" units to the network.
- Transmit the abnormalities of the "Slave" units to the network.
- ▶ Setting the plural "Master/Slave" units with the dip SW of the printed circuit board.
- ▶ Setting the "Master/Slave" remote controls with the dip SW of the remote control board.

### Plural Controls by Multiple Remote Controls. Mixture of Multiple Units

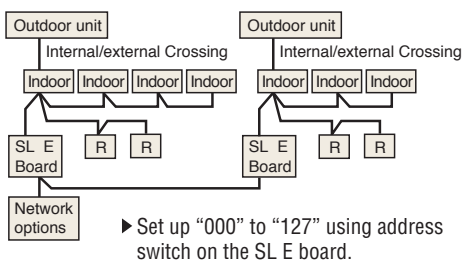

### Without Remote Control

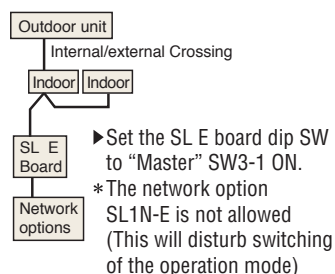

### Wireless Kit

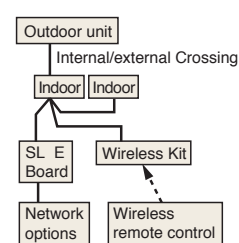

## External switch connection CNT, CNTA

All indoor units are equipped with an additional connection point CnT to connect indoor units to an external ON/OFF switch; e.g. time clock, fire alarm, etc.

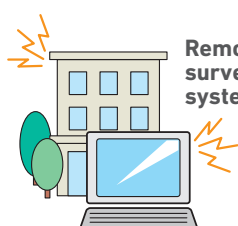

Remote surveillance system

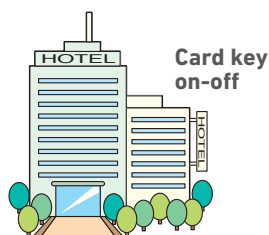

Card key on-off

# Energy Efficient and Environmentally Conscious

Several radical design changes and engineering developments have brought about a vast improvement in energy efficiency and environmental protection.

## ENERGY LABEL

SEER and SCOP is defined in European regulations listed below.

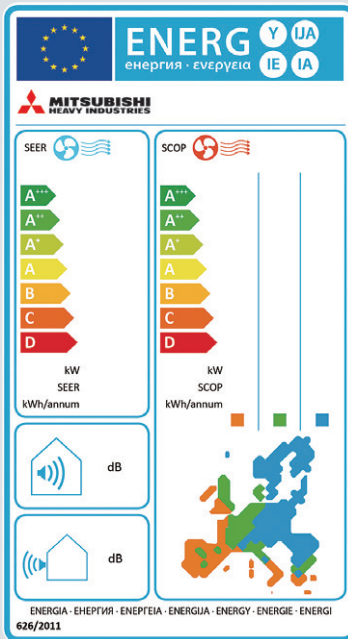

No.626/2011 of 4 May 2011:  
energy labeling of air-conditioners  
(below cooling capacity 12kW).

No.206/2012 of 6 March 2012:  
requirement for air-conditioners and comfort fans.

Seasonal efficiency is the new way of rating the true efficiency of heating and cooling products over an entire year.

Set by the EU's new regulation implementing Eco-Design Directive for Energy related Product (ErP) which specifies the minimum efficiency of air-conditioners manufacturers must integrate into their products.

The new Seasonal Efficiency rating system that must be used for heating and cooling by all manufacturers are;

**SEER - Seasonal Efficiency Ratio (value in cooling)**  
**SCOP - Seasonal Coefficient of Performance (value in heating)**

The new rating system will indicate the true efficiency of the energy using product at specified condition.

## Employment of lead-free solder

### Adapted to RoHS directive

#### RoHS:Restriction of Hazardous substances

In order to avoid the release of hazardous substances into the environments, all models have utilised lead-free solder application. It has been considered to be difficult to use lead-free solder for practical applications because it requires higher solder temperatures at assembly, which can jeopardize reliability. However our PbF soldering method can produce a higher quality lead-free printed circuit board.

## Employment of R32 R410A

All models use refrigerant R32 or R410A characterized by the ozone depletion coefficient being 0.

## Excellent Energy Saving

High performance and excellent energy savings are achieved at the same time by heat exchanger's increased capacity and employment of high efficiency DC motor.

Indoor unit	FDT40VH	FDT50VH	FDT60VH	FDT71VH	FDT100VH	FDT100VH	FDT40VHx2	FDT50VHx2
Outdoor unit	SRC40ZSX-W1	SRC50ZSX-W2	SRC60ZSX-W1	FDC71VNX-W	FDC100VNX-W	FDC100VNX-W	FDT71VNX-W	FDC100VNX-W
Energy class (cooling/heating)	A+++/A++	A++/A++	A+++/A++	A++/A++	A+/A+	A++/A+	A+++/A++	A++/A+
SEER	8.63	7.93	8.74	7.60	8.00	8.00	7.60	8.24
SCOP (Average climate)	4.62	4.63	5.00	4.61	4.44	4.44	4.66	4.24
Pdesign (cooling/heating (@-10°C)) kW	4.0/3.9	5.0/4.0	5.6/5.2	7.1/5.8	10.0/11.2	10.0/11.2	7.1/5.8	10.0/11.2
Annual electricity consumption (cooling/heating) kWh/a	163/1167	221/1210	225/1455	327/1762	438/3534	438/3534	327/1742	425/3700
Refrigerant	R32/675							
	GWP	1.30/0.878		2.75/1.86		4.0/2.7		2.75/1.86
Designated heating season	Average							

Indoor unit	FDT50VHx2	FDT40VH	FDT50VH	FDT60VH	FDT71VH	FDT100VH	FDT100VH	FDT40VHx2
Outdoor unit	FDC100VNX-W	SRC40ZSX-S	SRC50ZSX-S	SRC60ZSX-S	FDC71VNX	FDC100VNX	FDC100VNX	FDC100VNX
Energy class (cooling/heating)	A++/A+	A+++/A+	A+++/A++	A++/A++	A+/A+	A+/A+	A+/A+	A+/A+
SEER	8.24	8.51	7.82	8.26	5.72	5.90	5.90	5.77
SCOP (Average climate)	4.24	4.47	4.61	5.00	4.34	4.32	4.32	4.34
Pdesign (cooling/heating (@-10°C)) kW	10.0/11.2	4.0/3.8	5.0/4.1	5.6/4.7	7.1/5.8	10.0/11.2	10.0/11.2	7.1/5.8
Annual electricity consumption (cooling/heating) kWh/a	425/3700	165/1192	224/1246	238/1316	435/1873	594/3634	594/3634	431/1873
Refrigerant	R410A/2088							
	GWP	4.0/2.7		1.5/3.132		1.5/3.132		2.95/6.160
Designated heating season	Average							

Indoor unit	FDT50VHx2	FDT50VHx2	FDT100VH	FDT100VH	FDT50VHx2	FDT50VHx2	FDT100VH	FDT100VH
Outdoor unit	FDC100VNX	FDC100VNX	FDC100VNA-W	FDC100VSA-W	FDC100VNA-W	FDC100VSA-W	FDC100VNA	FDC100VSA
Energy class (cooling/heating)	A+/A+	A+/A+	A+++/A++	A++/A++	A++/A+	A++/A+	A+++/A+	A+++/A+
SEER	5.92	5.92	7.13	7.13	7.41	7.41	6.78	6.78
SCOP (Average climate)	4.16	4.16	4.60	4.60	4.47	4.47	4.52	4.52
Pdesign (cooling/heating (@-10°C)) kW	10.0/11.2	10.0/11.2	10.0/8.5	10.0/8.5	10.0/8.5	10.0/8.5	10.0/8.5	10.0/8.5
Annual electricity consumption (cooling/heating) kWh/a	592/3772	592/3772	491/2590	491/2590	473/2665	473/2665	516/2633	516/2633
Refrigerant	R410A/2088		R32/675			R410A/2088		
	GWP	4.5/9.396		3.30/2.228			3.8/7.934	
Designated heating season	Average							

• Refrigerant contained in the products is a fluorinated greenhouse gas listed in Regulation (EU) No 517/2014.  
 • SEER/SCOP are based on EN14825.2016 and Commission regulation(EU) No.2016/2281. Temperature conditions for calculating SCOP are based on "Average climate".  
 • 'tonne(s) of CO<sub>2</sub> equivalent' means a quantity of greenhouse gases- expressed as the product of the weight of the greenhouse gases in metric tonnes and of their global warming potential.

Indoor unit	FDT50VHx2	FDT50VHx2	FDT71VH	FDT100VH	FDT100VH	FDT71VH	FDT100VH	FDT100VH
Outdoor unit	FDC100VNA	FDC100VSA	FDC71VNP-W	FDC90VNP-W	FDC100VNP-W	FDC71VNP	FDC90VNP1	FDC100VNP
Energy class (cooling/heating)	A++/A+	A++/A+	A++/A+	A++/A+	A++/A+	A++/A+	A++/A+	A++/A+
SEER	6.89	6.89	6.34	7.10	7.08	6.14	6.78	6.78
SCOP (Average climate)	4.47	4.47	4.38	4.56	4.53	4.27	4.12	4.53
Pdesign (cooling/heating (@-10°C))	kW	10.0/8.5	10.0/8.5	7.10/5.70	9.0/6.0	10.0/6.4	7.1/5.7	9.0/8.1
Annual electricity consumption (cooling/heating)	kWh/a	508/2665	508/2665	393/1822	444/1842	495/1977	405/1867	465/2754
Refrigerant	GWP	R410A/2088		R32/675		R410A/2088		
	charge kgTCO <sub>2</sub> e	3.8/7.934		1.30/0.878	1.70/1.148		1.6/3.341	2.1/4.385
Designated heating season	Average							

Indoor unit	FDC40VH	FDC50VH	FDC60VH	FDC40VHx2	FDC50VHx2	FDC50VHx2	FDC40VH	FDC50VH	
Outdoor unit	SRC40ZSX-W1	SRC50ZSX-W2	SRC60ZSX-W1	FDC71VNX-W	FDC100VNX-W	FDC100VNX-W	SRC40ZSX-S	SRC50ZSX-S	
Energy class (cooling/heating)	A++/A+	A++/A+	A++/A+	A++/A+	A++/A+	A++/A+	A++/A+	A++/A+	
SEER	6.94	6.52	6.45	6.70	6.58	6.58	6.93	6.49	
SCOP (Average climate)	4.37	4.30	4.10	4.40	4.16	4.16	4.37	4.30	
Pdesign (cooling/heating (@-10°C))	kW	4.0/4.0	5.0/4.3	5.6/5.1	7.1/6.0	10.0/11.2	10.0/11.2	4.0/4.0	
Annual electricity consumption (cooling/heating)	kWh/a	202/1283	269/1401	304/1744	371/1911	532/3772	532/3772	202/1281	
Refrigerant	GWP	R32/675				R410A/2088			
	charge kgTCO <sub>2</sub> e	1.30/0.878		2.75/1.86		4.0/2.7		1.5/3.132	
Designated heating season	Average								

Indoor unit	FDC60VH	FDC40VHx2	FDC50VHx2	FDC50VHx2	FDC50VHx2	FDC50VHx2	FDC50VHx2	FDC50VHx2
Outdoor unit	SRC60ZSX-S	FDC71VNX	FDC100VNX	FDC100VNX	FDC100VNA-W	FDC100VNA-W	FDC100VNA	FDC100VSA
Energy class (cooling/heating)	A++/A+	A/A+	A/A	A/A	A++/A+	A++/A+	A++/A+	A++/A+
SEER	6.39	5.50	5.56	5.56	6.17	6.17	6.00	6.00
SCOP (Average climate)	4.09	4.05	3.87	3.87	4.38	4.38	4.38	4.38
Pdesign (cooling/heating (@-10°C))	kW	5.6/5.4	7.1/6.0	10.0/10.8	10.0/10.8	10.0/8.5	10.0/8.5	10.0/8.4
Annual electricity consumption (cooling/heating)	kWh/a	307/1848	453/2077	630/3910	630/3910	567/2715	584/2682	584/2682
Refrigerant	GWP	R410A/2088			R32/675		R410A/2088	
	charge kgTCO <sub>2</sub> e	1.5/3.132	2.95/6.160	4.5/9.396		3.3/2.228		3.8/7.934
Designated heating season	Average							

Indoor unit	FDU71VH	FDU100VH	FDU100VH	FDU71VH	FDU100VH	FDU100VH	FDU100VH	FDU100VH
Outdoor unit	FDC71VNX-W	FDC100VNX-W	FDC100VNX-W	FDC71VNX	FDC100VNX	FDC100VNX	FDC100VNA-W	FDC100VSA-W
Energy class (cooling/heating)	A++/A+	A++/A+	A++/A+	A/A	A/A+	A/A+	A++/A+	A++/A+
SEER	6.89	6.29	6.29	5.24	5.22	5.19	6.11	6.11
SCOP (Average climate)	4.47	4.13	4.13	3.90	4.10	4.10	4.19	4.19
Pdesign (cooling/heating (@-10°C))	kW	7.1/6.0	10.0/11.2	10.0/11.2	7.1/7.0	10.0/13.0	10.0/13.0	10.0/8.5
Annual electricity consumption (cooling/heating)	kWh/a	361/1878	557/3800	557/3800	475/2516	670/4441	675/4443	574/2843
Refrigerant	GWP	R32/675			R410A/2088		R32/675	
	charge kgTCO <sub>2</sub> e	2.75/1.86	4.0/2.7		2.95/6.160		4.5/9.396	
Designated heating season	Average							

Indoor unit	FDU100VH	FDU100VH	FDU71VH	FDU100VH	FDU100VH	FDU71VH	FDU100VH	FDU100VH
Outdoor unit	FDC100VNA	FDC100VSA	FDC71VNP-W	FDC90VNP-W	FDC100VNP-W	FDC71VNP	FDC90VNP1	FDC100VNP
Energy class (cooling/heating)	A++/A+	A++/A+	A+/A+	A++/A+	A++/A+	A+/A+	A++/A+	A++/A+
SEER	6.11	6.11	5.86	6.66	6.11	5.73	6.56	6.36
SCOP (Average climate)	4.19	4.19	4.12	4.22	4.13	4.00	3.98	4.13
Pdesign (cooling/heating (@-10°C))	kW	10.0/8.5	10.0/8.5	7.10/5.70	9.0/6.0	10.0/6.4	7.1/5.7	9.0/8.1
Annual electricity consumption (cooling/heating)	kWh/a	573/2844	573/2844	425/1937	474/1990	573/2169	434/1997	480/2850
Refrigerant	GWP	R410A/2088		R32/675		R410A/2088		
	charge kgTCO <sub>2</sub> e	3.8/7.934		1.30/0.878	1.7/1.148		1.6/3.341	2.1/4.385
Designated heating season	Average							

Indoor unit	FDUM40VH	FDUM50VH	FDUM60VH	FDUM71VH	FDUM100VH	FDUM100VH	FDUM40VHx2	FDUM50VHx2	
Outdoor unit	SRC40ZSX-W1	SRC50ZSX-W2	SRC60ZSX-W1	FDC71VNX-W	FDC100VNX-W	FDC100VNX-W	FDC71VNX-W	FDC100VNX-W	
Energy class (cooling/heating)	A++/A	A+/A	A++/A+	A++/A+	A++/A+	A++/A+	A++/A+	A++/A	
SEER	6.11	5.82	6.43	6.89	6.29	6.29	6.38	6.36	
SCOP (Average climate)	3.81	3.89	4.37	4.45	4.13	4.13	4.15	3.88	
Pdesign (cooling/heating (@-10°C))	kW	4.0/3.0	5.0/3.7	5.6/4.7	7.1/6.0	10.0/11.2	10.0/11.2	7.1/6.0	
Annual electricity consumption (cooling/heating)	kWh/a	230/1102	301/1332	305/1508	361/1878	557/3800	557/3800	390/2025	
Refrigerant	GWP	R32/675							
	charge kgTCO <sub>2</sub> e	1.30/0.878		2.75/1.86		4.0/2.7		2.75/1.86	4.0/2.7
Designated heating season	Average								

Indoor unit	FDUM50VHx2	FDUM40VH	FDUM50VH	FDUM60VH	FDUM71VH	FDUM100VH	FDUM100VH	FDUM40VHx2
Outdoor unit	FDC100VNX-W	SRC40ZSX-S	SRC50ZSX-S	SRC60ZSX-S	FDC71VNX	FDC100VNX	FDC100VNX	FDC71VNX
Energy class (cooling/heating)	A++/A	A+/A+	A+/A+	A++/A+	A/A	A/A+	A/A+	A+/A+
SEER	6.36	6.01	5.68	6.42	5.24	5.22	5.19	5.61
SCOP (Average climate)	3.88	4.15	4.36	4.37	3.90	4.10	4.10	4.05
Pdesign (cooling/heating (@-10°C))	kW	10.0/10.0	4.0/3.5	5.0/4.3	5.6/5.4	7.1/7.0	10.0/13.0	10.0/13.0
Annual electricity consumption (cooling/heating)	kWh/a	550/3605	233/1182	309/1380	306/1731	475/2516	670/4441	675/4444
Refrigerant	GWP	R32/675			R410A/2088			
	charge kgTCO <sub>2</sub> e	4.0/2.7	1.5/3.132		2.95/6.160		4.5/9.396	
Designated heating season	Average							

# Energy Efficient and Environmentally Conscious

Indoor unit	FDM50VHx2	FDM50VHx2	FDM100VH	FDM100VH	FDM50VHx2	FDM50VHx2	FDM100VH	FDM100VH
Outdoor unit	FDC100VNX	FDC100VXS	FDC100VNA-W	FDC100VSA-W	FDC100VNA-W	FDC100VSA-W	FDC100VNA	FDC100VSA
Energy class (cooling/heating)	A/A	A/A	A++/A+	A++/A+	A+/A+	A+/A+	A++/A+	A++/A+
SEER	5.14	5.11	6.11	6.11	5.82	5.82	6.11	6.11
SCOP (Average climate)	3.88	3.87	4.19	4.19	4.00	4.00	4.19	4.19
Pdesign (cooling/heating (@-10°C))	kW	10.0/10.0	10.0/10.0	10.0/8.5	10.0/8.5	10.0/8.5	10.0/8.5	10.0/8.5
Annual electricity consumption (cooling/heating)	kWh/a	681/3606	685/3618	574/2843	574/2843	602/2974	573/2844	573/2844
Refrigerant	GWP	R410A/2088			R32/675			R410A/2088
	charge kg/TCO <sub>2</sub> e	4.5/9.396			3.3/2.228			3.8/7.934
Designated heating season	Average							

Indoor unit	FDM50VHx2	FDM50VHx2	FDM71VH	FDM100VH	FDM100VH	FDM71VH	FDM100VH	FDM100VH
Outdoor unit	FDC100VNA	FDC100VSA	FDC71VNP-W	FDC90VNP-W	FDC100VNP-W	FDC71VNP	FDC90VNP1	FDC100VNP
Energy class (cooling/heating)	A/A	A/A	A+/A+	A++/A+	A+/A+	A+/A+	A+/A+	A+/A+
SEER	5.50	5.50	5.86	6.65	6.11	5.73	6.56	6.36
SCOP (Average climate)	3.94	3.94	4.12	4.22	4.13	4.00	3.98	4.13
Pdesign (cooling/heating (@-10°C))	kW	10.0/8.5	10.0/8.5	7.10/5.70	9.0/6.0	10.0/6.4	7.1/5.7	9.0/8.1
Annual electricity consumption (cooling/heating)	kWh/a	637/3024	637/3024	425/1937	474/1990	573/2169	434/1997	480/2850
Refrigerant	GWP	R410A/2088		R32/675			R410A/2088	
	charge kg/TCO <sub>2</sub> e	3.8/7.934		1.3/0.878	1.7/1.148		1.6/3.341	2.1/4.385
Designated heating season	Average							

Indoor unit	SRK71ZR-W	SRK100ZR-W(F)	SRK100ZR-W(F)	SRK50ZSX-Wx2	SRK50ZSX-Wx2	SRK50ZSX-Wx2	SRK50ZSX-Wx2	SRK100ZR-W(F)
Outdoor unit	FDC71VNX-W	FDC100VNX-W	FDC100VXS-W	FDC100VNX-W	FDC100VXS-W	FDC100VNX	FDC100VXS	FDC100VNA-W
Energy class (cooling/heating)	A++/A+	A+/A+	A+/A+	A++/A+	A+/A+	A+/A+	A+/A+	A+/A+
SEER	6.80	6.54	6.54	7.66	7.66	6.11	6.11	6.13
SCOP (Average climate)	4.56	4.01	4.01	4.25	4.25	4.16	4.16	4.33
Pdesign (cooling/heating (@-10°C))	kW	7.1/5.8	10.0/10.5	10.0/10.5	10.0/11.2	10.0/11.2	10.0/10.4	10.0/8.5
Annual electricity consumption (cooling/heating)	kWh/a	366/1782	535/3671	535/3671	457/3691	457/3691	574/3504	574/3504
Refrigerant	GWP	R32/675			R410A/2088			R32/675
	charge kg/TCO <sub>2</sub> e	2.75/1.86	4.0/2.7		4.5/9.396			3.3/2.228
Designated heating season	Average							

Indoor unit	SRK100ZR-W(F)	SRK50ZSX-Wx2	SRK50ZSX-Wx2	SRK100ZR-W	SRK100ZR-W	SRK71ZR-W	SRK100ZR-W(F)	SRK100ZR-W
Outdoor unit	FDC100VSA-W	FDC100VNA-W	FDC100VSA-W	FDC100VNA	FDC100VSA	FDC71VNP-W	FDC100VNP-W	FDC100VNP
Energy class (cooling/heating)	A++/A+	A+/A+	A+/A+	A+/A+	A+/A+	A+/A+	A+/A+	A+/A+
SEER	6.13	7.05	7.05	6.26	6.26	6.75	6.11	6.60
SCOP (Average climate)	4.33	4.47	4.47	4.33	4.33	4.55	4.14	4.40
Pdesign (cooling/heating (@-10°C))	kW	10.0/8.5	10.0/8.5	10.0/8.5	10.0/8.5	7.10/5.70	9.6/6.0	10.0/7.2
Annual electricity consumption (cooling/heating)	kWh/a	571/2746	497/2661	497/2661	560/2750	560/2750	369/1756	551/2028
Refrigerant	GWP	R32/675		R410A/2088		R32/675		R410A/2088
	charge kg/TCO <sub>2</sub> e	3.3/2.228		3.8/7.934		1.3/0.878	1.7/1.148	2.55/5.324
Designated heating season	Average							

Indoor unit	FDE40VH	FDE50VH	FDE60VH	FDE71VH	FDE100VH	FDE100VH	FDE40VHx2	FDE50VHx2
Outdoor unit	SRC40ZSX-W1	SRC50ZSX-W2	SRC60ZSX-W1	FDC71VNX-W	FDC100VNX-W	FDC100VXS-W	FDC71VNX-W	FDC100VNX-W
Energy class (cooling/heating)	A++/A+	A+/A+	A+/A+	A++/A+	A+/A+	A+/A+	A+/A+	A+/A+
SEER	6.46	6.15	6.72	6.58	7.00	7.00	6.48	6.76
SCOP (Average climate)	4.02	4.07	4.41	4.45	4.24	4.24	4.49	4.00
Pdesign (cooling/heating (@-10°C))	kW	4.0/3.0	5.0/3.8	5.6/4.5	7.1/6.0	10.0/11.2	7.1/6.0	10.0/9.8
Annual electricity consumption (cooling/heating)	kWh/a	217/1045	285/1307	292/1430	378/1889	501/3700	501/3700	384/1870
Refrigerant	GWP	R32/675			R410A/2088		R32/675	
	charge kg/TCO <sub>2</sub> e	1.30/0.878			2.75/1.86	4.0/2.7		2.75/1.86
Designated heating season	Average							

Indoor unit	FDE50VHx2	FDE40VH	FDE50VH	FDE60VH	FDE71VH	FDE100VH	FDE100VH	FDE40VHx2
Outdoor unit	FDC100VXS-W	SRC40ZSX-S	SRC50ZSX-S	SRC60ZSX-S	FDC71VNX	FDC100VNX	FDC100VXS	FDC71VNX
Energy class (cooling/heating)	A++/A+	A+/A+	A+/A+	A+/A+	B/A+	A+/A+	A+/A+	A+/A+
SEER	6.76	6.46	6.10	6.72	4.87	5.89	5.84	5.26
SCOP (Average climate)	4.00	3.93	3.92	4.08	4.00	4.18	4.17	4.09
Pdesign (cooling/heating (@-10°C))	kW	10.0/9.8	4.0/3.0	5.0/3.8	5.6/4.3	7.1/6.0	10.0/11.2	10.0/11.2
Annual electricity consumption (cooling/heating)	kWh/a	518/3434	217/1070	288/1359	292/1476	511/2102	595/3756	599/3762
Refrigerant	GWP	R32/675			R410A/2088		R32/675	
	charge kg/TCO <sub>2</sub> e	4.0/2.7			1.5/3.132	2.95/6.160	4.5/9.396	
Designated heating season	Average							

Indoor unit	FDE50VHx2	FDE50VHx2	FDE100VH	FDE100VH	FDE50VHx2	FDE50VHx2	FDE100VH	FDE100VH
Outdoor unit	FDC100VNX	FDC100VXS	FDC100VNA-W	FDC100VSA-W	FDC100VNA-W	FDC100VSA-W	FDC100VNA	FDC100VSA
Energy class (cooling/heating)	A/A	A/A	A+/A+	A+/A+	A+/A+	A+/A+	A+/A+	A+/A+
SEER	5.53	5.49	6.67	6.67	6.16	6.16	6.35	6.35
SCOP (Average climate)	3.94	3.94	4.31	4.31	4.10	4.10	4.31	4.31
Pdesign (cooling/heating (@-10°C))	kW	10.0/10.8	10.0/10.8	10.0/8.5	10.0/8.5	10.0/8.5	10.0/8.5	10.0/8.5
Annual electricity consumption (cooling/heating)	kWh/a	634/3840	638/3841	525/2764	525/2764	569/2906	569/2906	552/2763
Refrigerant	GWP	R410A/2088		R32/675			R410A/2088	
	charge kg/TCO <sub>2</sub> e	4.5/9.396		3.30/2.228			3.8/7.934	
Designated heating season	Average							

Indoor unit		FDE50VHx2	FDE50VHx2	FDE71VH	FDE100VH	FDE100VH	FDE71VH	FDE100VH	FDE100VH	
Outdoor unit		FDC100VNA	FDC100VSA	FDC71VNP-W	FDC90VNP-W	FDC100VNP-W	FDC71VNP	FDC90VNP1	FDC100VNP	
<b>Energy class (cooling/heating)</b>		A+/A+	A+/A+	A++/A+	A++/A+	A++/A+	A++/A+	A++/A+	A++/A+	
<b>SEER</b>		5.71	5.71	6.44	6.78	6.63	6.35	6.63	6.73	
<b>SCOP (Average climate)</b>		4.10	4.10	4.32	4.46	4.24	4.22	4.25	4.44	
<b>Pdesign (cooling/heating (@-10°C))</b>	<b>kW</b>	10.0/8.5	10.0/8.5	7.10/5.70	9.0/5.8	10.0/6.0	7.1/5.8	9.0/8.2	10.0/8.1	
<b>Annual electricity consumption (cooling/heating)</b>	<b>kWh/a</b>	613/2905	613/2905	386/1849	465/1822	529/1984	392/1927	475/2703	521/2555	
<b>Refrigerant</b>	<b>GWP</b>	R410A/2088			R32/675			R410A/2088		
	<b>charge kg/TCO<sub>2</sub>e</b>	3.8/7.934			1.30/0.878		1.70/1.148		2.55/5.324	
<b>Designated heating season</b>		Average								

Indoor unit		FDF71VH	FDF100VH	FDF100VH	FDF71VD1	FDF100VD2	FDF100VD2	FDF100VH	FDF100VH	
Outdoor unit		FDC71VNX-W	FDC100VNX-W	FDC100VNX-W	FDC71VNX	FDC100VNX	FDC100VNX	FDC100VNA-W	FDC100VSA-W	
<b>Energy class (cooling/heating)</b>		A++/A+	A++/A	A++/A	B/A	A/A	A/A	A+/A+	A+/A+	
<b>SEER</b>		6.25	6.10	6.10	4.80	5.20	5.17	5.76	5.76	
<b>SCOP (Average climate)</b>		4.03	3.84	3.84	3.81	3.80	3.80	4.00	4.00	
<b>Pdesign (cooling/heating (@-10°C))</b>	<b>kW</b>	7.1/6.0	10.0/11.2	10.0/11.2	7.1/6.7	10.0/13.0	10.0/13.0	10.0/8.50	10.0/8.50	
<b>Annual electricity consumption (cooling/heating)</b>	<b>kWh/a</b>	376/2085	574/4084	574/4084	518/2464	673/4792	678/4795	608/2973	608/2973	
<b>Refrigerant</b>	<b>GWP</b>	R32/675			R410A/2088			R32/675		
	<b>charge kg/TCO<sub>2</sub>e</b>	2.75 / 1.86		4.0 / 2.7		2.95/6.160		4.5/9.396		3.3/2.23
<b>Designated heating season</b>		Average								

Indoor unit		FDF100VD2	FDF100VD2	FDF71VH	FDF100VH	FDF100VH	FDF71VD1	FDF100VD2	FDF100VD2	
Outdoor unit		FDC100VNA	FDC100VSA	FDC71VNP-W	FDC90VNP-W	FDC100VNP-W	FDC71VNP	FDC90VNP1	FDC100VNP	
<b>Energy class (cooling/heating)</b>		A+/A+	A+/A+	A+/A	A+/A+	A/A	A/A	A+/A+	A/A	
<b>SEER</b>		5.70	5.70	5.85	5.90	5.43	5.25	5.69	5.41	
<b>SCOP (Average climate)</b>		4.00	4.00	3.91	4.24	3.94	3.91	4.01	3.94	
<b>Pdesign (cooling/heating (@-10°C))</b>	<b>kW</b>	10.0/8.5	10.0/8.5	7.10/5.70	9.0/6.0	10.0/6.40	7.1/5.5	9.0/8.1	10.0/8.1	
<b>Annual electricity consumption (cooling/heating)</b>	<b>kWh/a</b>	614/2978	614/2978	425/2039	535/1981	645/2274	474/1972	554/2825	647/2875	
<b>Refrigerant</b>	<b>GWP</b>	R410A/2088			R32/675			R410A/2088		
	<b>charge kg/TCO<sub>2</sub>e</b>	3.8/7.934			1.6/3.341		1.7/1.15		2.55/5.324	
<b>Designated heating season</b>		Average								

- Refrigerant contained in the products is a fluorinated greenhouse gas listed in Regulation (EU) No 517/2014.
- SEER/SCOP are based on EN14825:2016 and Commission regulation(EU) No.2016/2281. Temperature conditions for calculating SCOP are based on 'Average climate'.
- 'tonne(s) of CO<sub>2</sub> equivalent' means a quantity of greenhouse gases- expressed as the product of the weight of the greenhouse gases in metric tonnes and of their global warming potential.

**SEER and SCOP is defined in European regulations listed below.**

No.2016/2281: requirement for air-heating products, cooling products, high temperature process chillers and fan coil units. Seasonal efficiency is the new way of rating the true efficiency of heating and cooling products over an entire year.  
 Set by the EU's new regulation implementing Eco-Design Directive for Energy Related Product (ErP) which specifies the minimum efficiency of air-conditioners manufacturers must integrate into their products.  
 The new Seasonal Efficiency rating system that must be used for heating and cooling by all manufacturers are;

Indoor unit	FDT125VH	FDT140VH	FDT125VH	FDT140VH	FDT125VH	FDT140VH	FDT125VH	FDT140VH	FDT125VH	FDT140VH	FDT125VH	FDT140VH
Outdoor unit	FDC125VNX-W	FDC140VNX-W	FDC125VNX-W	FDC140VNX-W	FDC125VNX	FDC140VNX	FDC125VNX	FDC140VNX	FDC125VNA-W	FDC140VNA-W	FDC125VSA-W	FDC140VSA-W
<b>SEER</b>	7.64	7.20	7.64	7.20	6.18	5.97	6.18	6.11	6.53	6.17	6.53	6.17
<b>SCOP (Average climate)</b>	4.44	4.35	4.26	4.14	4.08	4.05	4.03	3.99	4.38	4.42	4.38	4.42

Indoor unit	FDU125VH	FDU140VH	FDU125VH	FDU140VH	FDU125VH	FDU140VH	FDU125VH	FDU140VH	FDU125VH	FDU140VH	FDU125VH	FDU140VH
Outdoor unit	FDC125VNA	FDC140VNA	FDC125VSA	FDC140VSA	FDC125VNP-W	FDC125VNX-W	FDC140VNX-W	FDC125VNX-W	FDC140VNX-W	FDC125VNX	FDC140VNX	FDC125VNX
<b>SEER</b>	6.52	6.16	6.52	6.16	6.37	6.10	5.79	6.10	5.79	5.34	5.22	5.49
<b>SCOP (Average climate)</b>	4.38	4.28	4.38	4.28	4.27	4.06	3.99	3.92	3.88	3.87	3.85	3.91

Indoor unit	FDU140VH	FDU125VH	FDU140VH	FDU125VH	FDU140VH	FDU200VH	FDU250VH	FDU280VH	FDU125VH	FDU140VH	FDU125VH	FDU140VH
Outdoor unit	FDC140VSA	FDC125VNA-W	FDC140VNA-W	FDC125VSA-W	FDC140VSA-W	FDC200VSA-W	FDC250VSA-W	FDC280VSA-W	FDC125VNA	FDC140VNA	FDC125VSA	FDC140VSA
<b>SEER</b>	5.36	5.57	5.30	5.57	5.30	5.10	4.88	4.92	5.26	5.08	5.26	5.08
<b>SCOP (Average climate)</b>	3.88	4.13	4.01	4.13	4.01	3.55	3.54	3.70	4.13	4.01	4.13	4.01

Indoor unit	FDU200VH	FDU250VH	FDU125VH	FDU125VH	FDU140VH	FDU125VH	FDU140VH	FDU125VH	FDU140VH	FDU125VH	FDU140VH	FDU125VH
Outdoor unit	FDC200VSA	FDC250VSA	FDC125VNP-W	FDC125VNX-W	FDC140VNX-W	FDC125VNX-W	FDC140VNX-W	FDC125VNX	FDC140VNX	FDC125VNX	FDC140VNX	FDC125VNA-W
<b>SEER</b>	5.06	4.82	5.50	6.10	5.79	6.10	5.79	5.34	5.22	5.49	5.36	5.57
<b>SCOP (Average climate)</b>	3.52	3.51	4.01	4.06	3.99	3.92	3.88	3.87	3.85	3.91	3.88	4.13

Indoor unit	FDUM140VH	FDUM125VH	FDUM140VH	FDUM125VH	FDUM140VH	FDUM125VH	FDUM140VH	FDUM125VH	FDE125VH	FDE140VH	FDE125VH	FDE140VH
Outdoor unit	FDC140VNA-W	FDC125VNA-W	FDC140VSA-W	FDC125VNA	FDC140VNA	FDC125VSA	FDC140VSA	FDC125VNP-W	FDC125VNX-W	FDC140VNX-W	FDC125VNX	FDC140VNX
<b>SEER</b>	5.30	5.57	5.30	5.57	5.30	5.26	5.08	5.50	6.53	6.29	6.53	6.29
<b>SCOP (Average climate)</b>	4.01	4.13	4.01	4.13	4.01	4.13	4.01	4.01	4.20	4.17	4.02	3.96

Indoor unit	FDE125VH	FDE140VH	FDE125VH	FDE140VH	FDE125VH	FDE140VH	FDE125VH	FDE140VH	FDE125VH	FDE140VH	FDE125VH	FDE140VH
Outdoor unit	FDC125VNX	FDC140VNX	FDC125VNX	FDC140VNX	FDC125VNA-W	FDC140VNA-W	FDC125VSA-W	FDC140VSA-W	FDC125VNA	FDC140VNA	FDC125VSA	FDC140VSA
<b>SEER</b>	5.56	5.41	5.74	5.56	6.03	5.76	6.03	5.76	6.03	5.76	6.03	5.76
<b>SCOP (Average climate)</b>	3.71	3.66	3.66	3.62	4.30	4.24	4.30	4.24	4.30	4.15	4.30	4.15

Indoor unit	FDF125VH	FDF125VH	FDF140VH	FDF125VH	FDF140VH	FDF125VD	FDF140VD	FDF125VD	FDF140VD	FDF125VH	FDF140VH	FDF125VH
Outdoor unit	FDC125VNP-W	FDC125VNX-W	FDC140VNX-W	FDC125VNX-W	FDC140VNX-W	FDC125VNX	FDC140VNX	FDC125VNX	FDC140VNX	FDC125VNA-W	FDC140VNA-W	FDC125VSA-W
<b>SEER</b>	5.95	5.96	5.81	5.96	5.81	4.97	4.80	5.11	4.94	5.36	5.19	5.36
<b>SCOP (Average climate)</b>	4.21	3.89	3.81	3.85	3.72	3.60	3.56	3.60	3.60	3.96	3.99	3.96

Indoor unit	FDF140VH	FDF125VD	FDF140VD	FDF125VD	FDF140VD
Outdoor unit	FDC140VSA-W	FDC125VNA	FDC140VNA	FDC125VSA	FDC140VSA
<b>SEER</b>	5.19	5.36	5.09	5.36	5.03
<b>SCOP (Average climate)</b>	3.99	3.96	4.16	3.96	4.16

## Before starting use

### Heating performance

The heating performance values (kW) described in the catalogue are the values obtained by operating at an outdoor temperature of 7°C and indoor temperature of 20°C as set forth in the ISO Standards. Heating performance is reduced as the temperature drops, the outdoor temperature is too low and the heating performance is insufficient, use other heating appliances as well.

### Indication of sound values

The sound values are the values (A scale) measured in a chamber such as an anechoic chamber following the ISO Standards. In the actual installation state, the value is normally larger than the values given in the catalogue due to the effect of surrounding noise and echo. Take this into consideration when installing.

### Use in oil atmosphere

Avoid installing this unit in an atmosphere where oil scatters or builds up, such as in a kitchen or machine factory.

If the oil adheres to the heat exchanger, the heat exchanging performance will drop, mist may be generated, and the synthetic resin parts may deform and break.

### Use in acidic or alkaline atmosphere

If this unit is used in acidic atmosphere such as hot spring areas having high level of sulfuric gases or in alkaline atmosphere including ammonia or calcium chloride, places where the exhaust of the heat exchanger is sucked in, or at coastal areas where the unit is subject to salt breezes, the outer plate or heat exchanger, etc., will corrode. Please ask a dealer or specialist when you use an air conditioner in places differing from a general atmosphere.

### Use in places with high ceilings

If the ceiling is high, install a circulator to improve the heat and air flow distribution when heating.

### Refrigerant leakage

The refrigerant (R32,R410A) used for air conditioner is non-toxic and in its original state.

However, in consideration of a state where the refrigerant leaks into the room, measures against refrigerant leaks must be taken in small rooms where the tolerable level could be exceeded. Take measures by installing ventilation devices, etc.

### Use in snowy areas

Take the following measures when installing the outdoor unit in snowy areas.

#### •Snow prevention

Install a snow-prevention hood so that the snow does not obstruct the air intake port or enter and freeze in the outdoor unit.

#### •Snow piling

In areas with heavy snow fall, the piled snow could block the air intake port. In this case, a frame that is 50cm or higher than the estimated snow fall must be installed underneath the outdoor unit.

### Automatic defrosting device

If the temperature is low, and the humidity is high, frost will stick to the heat exchanger of the outdoor unit. If continued to use, the heating performance will drop.

The "Automatic defrosting device" will function to remove this frost. After heating for approx. three to ten minutes, it will stop, and the frost will be removed. After defrosting, hot air will be blown again.

### Servicing

After the air conditioner has been used for several seasons, dirt will build up in the air conditioner causing the performance to drop. In addition to regular servicing, a maintenance contract by a specialist is recommended.

## Safety Precautions

### Air conditioner usage target

The air conditioner described in this catalogue is a dedicated cooling/heating device for human use.

Do not use it for special applications such as the storage of food items, animals or plants, precision devices or valuable art, etc.

This could cause the quality of the items to drop, etc.

Do not use this for cooling vehicles or ships. Water leakage or current leaks could occur.

### Before use

Always read the "User's Manual" thoroughly before starting use.

### Installation

Always commission the installation to a dealer or specialist. Improper installation will lead to water leakage, electric shocks and fires.

Make sure that the outdoor unit is stable in installation. Fix the unit to stable base.

### Usage place

Do not install in places where combustible gas could leak or where there are sparks. Installation in a place where combustible gas could be generated, flow or accumulate, or places containing carbon fibers could lead to fires.

## Mitsubishi Heavy Industries Thermal Systems, Ltd.

(Wholly-owned subsidiary of MITSUBISHI HEAVY INDUSTRIES, LTD.)

2-3 Marunouchi 3-chome, Chiyoda-ku, Tokyo 100-8332, Japan

<https://www.mhi-mth.co.jp/en/>

Our factories are ISO9001 and ISO14001 certified.

Certified ISO 9001



Certificate Number: JQA-0709



Certificate:44 100 980813



Certificate Number: 4333-2007-AQ-RGC-RvA

Certified ISO 14001



Certificate:04 104 980813



Certificate number: 02117E1016R0M



Mitsubishi Heavy Industries Thermal Systems, Ltd. Participate in the Eurovent certification program for comfort air conditioner (AC1 & AC2). Check ongoing validity of certificate: [www.eurovent-certification.com](http://www.eurovent-certification.com)

